

ASTROAI

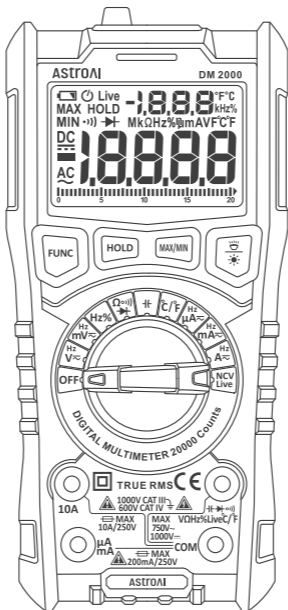

DM2000

TRUE RMS DIGITAL MULTIMETER

USER MANUAL

EN

CATALOG

INTRODUCTION	02
WARNING	03
PACKAGE INCLUDES	04
ELECTRICAL SYMBOLS	05
DIMENSIONS	05
DIAGRAM	06
BUTTON FUNCTIONS	07
SETTING FUNCTIONS	08
OTHER FUNCTIONS	09
PREPARATION	10
INSTRUCTIONS	11
MAINTENANCE	21
SPECIFICATIONS	23
DETAILED SPECIFICATIONS	23
RECYCLING	28
WARRANTY PERIOD	28

INTRODUCTION

Thank you for purchasing the Auto Ranging 20000 Counts Digital Multimeter from AstroAI.

The AstroAI True RMS Digital Multimeter is designed to be safely and accurately used in schools, laboratories, factories and other social/ industrial fields. This user manual provides all safety, operation, specification, and maintenance information for the meter. This instrument performs AC/DC Voltage, AC/DC Current, Resistance, Frequency, Duty Ratio, Temperature, Capacitance, NCV, Live Wire Testing, Diode Testing and Continuity Testing.

Thank you again for choosing AstroAI, if you have any questions or concerns regarding your product, please contact us at

support@astroai.com



Fully read and comprehend this manual before using this Digital Multimeter.

WARNING

To avoid possible electric shocks or personal injury, and to avoid damaging the meter or the equipment being tested, adhere to the following rules:















- Use the meter strictly in accordance with this manual otherwise, the built-in protection provided by the meter may be damaged or weakened.
- Please be especially careful when measuring over 60 V DC, 30 V AC RMS or 42 V peak value, there is an increased danger of an electric shock in these ranges.
- Do not apply more than the rated voltage, as marked on the meter, between the terminals or between any terminal and grounding.
- Check whether the meter is working normally by measuring a known voltage, do not use it if the readings are incorrect or if the meter is damaged.
- Before using the meter, please check if there are cracks or any damage to the plastic parts of the meter's casing. Do not use the meter if any part of the exterior casing is damaged.
- Before using the meter, please check whether the test leads are cracked or damaged. If damaged, please replace them with test leads of the same model and electrical specifications.
- Use the meter according to the measurement category, voltage or current rating specified on the meter or manual.
- Comply with local and national safety regulations. Wear personal protective equipment (such as approved rubber gloves, masks, flame-resistant clothing, etc.) to prevent injury from electric shocks and arcs when hazardous live conductors are exposed.

- To avoid measurement errors, replace the battery as soon as the low-battery indicator appears.
- Do not use the meter around explosive gas, steam, or in humid environments.
- When using the test leads, keep your fingers behind the finger guards.
- When measuring, connect the neutral wire or ground wire first, then connect the live wire. When disconnecting, disconnect the live wire first, and then disconnect the neutral wire and ground wire.
- Before opening the case or battery cover, remove the test leads from the meter first. Do not use the meter while it is disassembled or when the battery cover is opened.
- To ensure your safety, the meter can only be used with the equipped test leads. If the test leads are damaged and need to be replaced, only replace them with the same model and electrical specifications.

PACKAGE INCLUDES

User Manual	x 1
Pair of Test Leads	x 1
K-Type Thermocouple	x 1
Storage Bag	x 1
AstroAI Digital Multimeter	x 1

ELECTRICAL SYMBOLS

- | | | | |
|--|-----------------------|---|-----------------------------|
|  | High Voltage |  | Alternating Current |
|  | Direct Current |  | Data Hold |
|  | AC Current/DC Current |  | Resistance Test |
|  | Capacitance |  | Earth Ground |
|  | Fuse |  | Double Insulation |
|  | Continuity Test |  | Low Voltage |
|  | Diode Test |  | Compliant with EU Standards |
|  | Warning | | |

DIMENSIONS

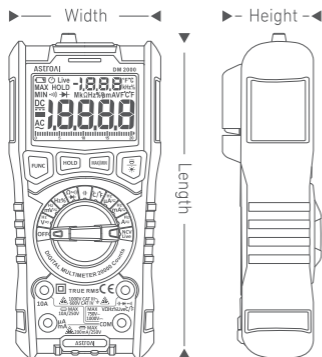

Length: 7.48 inches (18.8 cm)

Width: 3.46 inches (8.8 cm)

Height: 2.28 inches (5.8 cm)

DIAGRAM

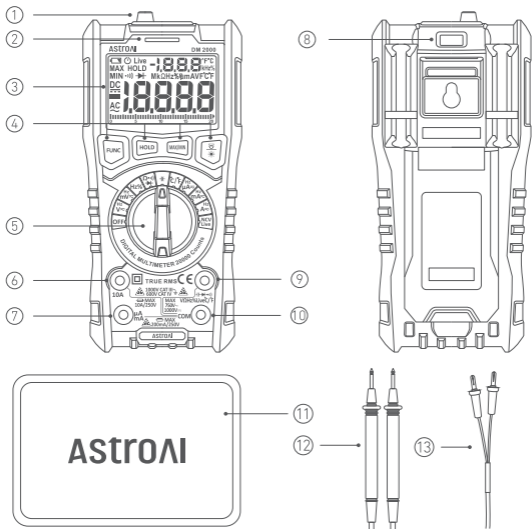

- ① NCV Detector
- ② Red/Green Indicator
- ③ Screen
- ④ FUNC Button
- ⑤ Rotary Switch
- ⑥ 10 A Current Terminal
- ⑦ mA, μ A Terminal
- ⑧ Flashlight
- ⑨ Other Input Terminal
- ⑩ COM Terminal
- ⑪ Storage Bag
- ⑫ Test Leads
- ⑬ K-Type Thermocouple

BUTTON FUNCTIONS

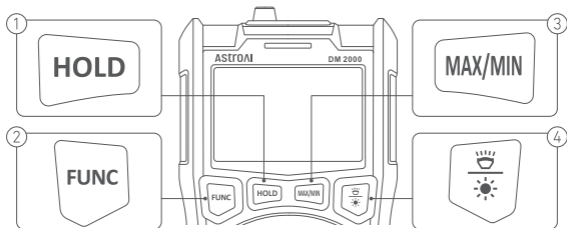

① Data Hold

Press the "HOLD" Button to hold/cancel the data.

② FUNC Button

Use the "FUNC" Button to select a specific function if there are multiple functions in one rotary setting.

③ MAX/MIN Button

Press the "MAX/MIN" Button to record the maximum and minimum readings alternately. Press and hold the button for 2 seconds to exit this function.

④ Backlight/Flashlight Button

- Backlight: Press this button to turn the backlight on/off.
- Flashlight: Press and hold this button for 3 seconds to turn the flashlight on/off.

SETTING FUNCTIONS

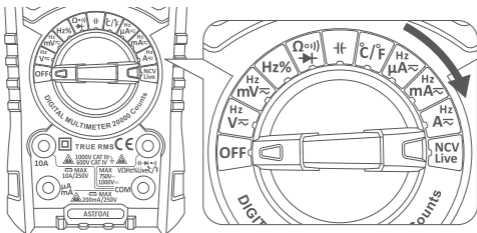

Note: Use the “FUNC” Button to select a specific function if there are multiple functions in one rotary setting.

V \approx DC Voltage Test: 0~1000 V; AC Voltage Test: 0~750 V

mV \approx AC/DC Voltage Test: 0-200 mV

Hz Frequency

% Duty Ratio

Ω Resistance Test: 0.01 Ω-100 MΩ

⎓ Capacitance Test: 0.000 1 nF~20 mF

o||) Continuity Test

→| Diode Test

°F Degree Fahrenheit

°C Degree Celsius

μA \approx AC/DC Current Test: 0~2000 uA

mA \approx AC/DC Current Test: 0~200 mA

A \approx AC/DC Current Test: 0~10 A

NCV NCV Detection

Live Live Wire Detection

OTHER FUNCTIONS

Auto Shutoff

- After 15 minutes without user input, the meter will automatically turn off to save energy. Press any button to turn it on.
- Press the "FUNC" Button and turn on the meter; it will emit a harsh beep sound to indicate the exit of the auto-shutoff function. Restart the meter to activate the auto-shutoff function.

INPUT Indicator

The indicator light on the INPUT terminal will flash when the meter is powered on or the function is selected.

High-Voltage Indicator

The screen will display an orange backlight to warn users when the measuring voltage exceeds 80 V, or the measuring current exceeds 1 A.

Low-Voltage Indicator

The screen will display the "  " symbol when the battery voltage is insufficient.

AC Frequency Display

The screen will display the frequency of the voltage/current when testing the AC voltage/current.

PREPARATION

Continuity Test

1. Turn the rotary dial to the " Ω " setting and press the "FUNC" Button to choose the continuity function. The screen will display the " Ω " symbol.

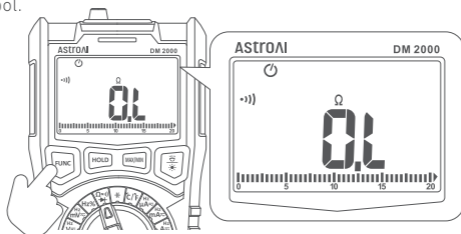

2. Insert the red test lead into the " Ω LiveC/F" terminal, and the black test lead into the "COM" terminal.
3. Touch the red and black test leads together to check whether they are functioning normally. The buzzer will beep if the test leads are normal.

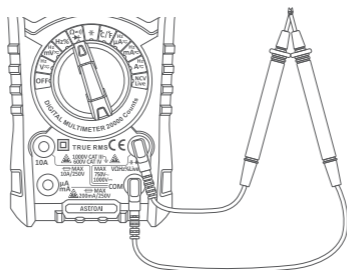

INSTRUCTIONS

Warning

- Do not measure if the voltage exceeds 750 V AC or 1000 V DC. Failure to do so may damage the meter.
- Pay special attention to safety when measuring high voltages to avoid electric shock or other personal injuries.
- Before using the meter, test a known voltage or current with it to confirm that the meter works properly.

DC/AC Voltage Measurement

1. Turn the rotary dial to the " $\frac{Hz}{V}$ " setting. Turn the rotary dial to the " $\frac{mV}{V}$ " setting if the target voltage is lower than 200 mV. Press the "FUNC" Button to choose between the AC/DC voltage function. The screen will display "DC" when testing DC voltage and "AC" when testing AC voltage.

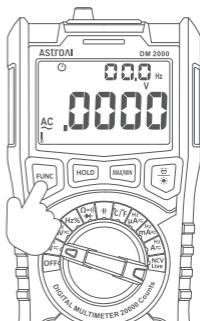

- Insert the red test lead into the “ $\sqrt{\text{Hz}}\% \text{LiveC/F}$ ” terminal, and the black test lead into the “COM” terminal.

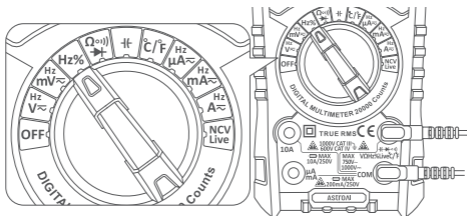

- Connect the test leads to the circuit being tested (in parallel), to test the frequency/ duty ratio.
- Both the frequency and duty ratio will display on the screen.

AC/DC Current Measurement

- Turn the rotary switch to the “ μA ”, “ mA ” or “ A ”, setting based on the estimated current value and press the “FUNC” Button to choose between AC/DC current. The screen will display “DC” when testing DC voltage and “AC” when testing the AC voltage.

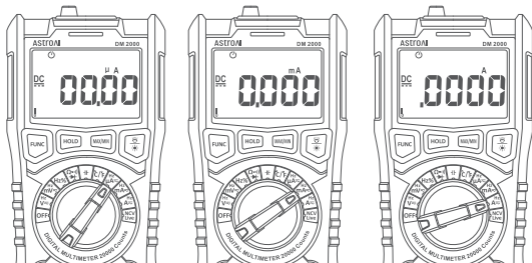

- In the " μA " and " mA " settings, connect the red test lead to the " μA " terminal and the black test lead to the "COM" terminal.
In the " A " setting, connect the red test lead to the "10 A" terminal and the black test lead to the "COM" terminal.

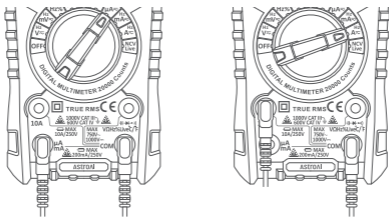

- Power off the circuit being tested and connect the meter to the circuit in parallel. Then, power on the circuit.
- Record the stabilized reading on the screen.

Note: The screen will light up in orange when the testing current exceeds 1A.

Resistance Measurement

- Turn the rotary dial to the " Ω " setting and press the "FUNC" Button to choose the resistance function. Ensure the circuit being tested has been powered off.

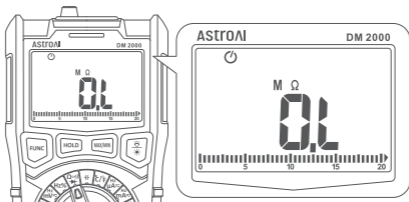

- Insert the red test lead into the “ \overline{V} Hz%LiveC/F” terminal, and the black test lead into the “COM” terminal.

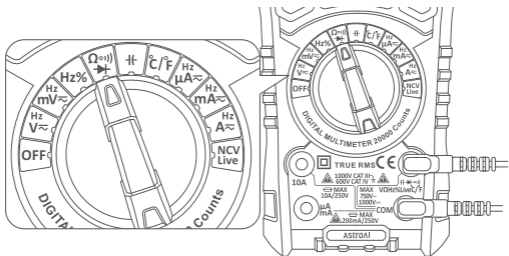

- Connect the ASTROAI test leads to the circuit or the resistance to be tested.
- Record the stabilized reading from the screen.

Capacitance Measurement

- Turn the rotary dial to the “ \overline{F} ” setting and power off the circuit.

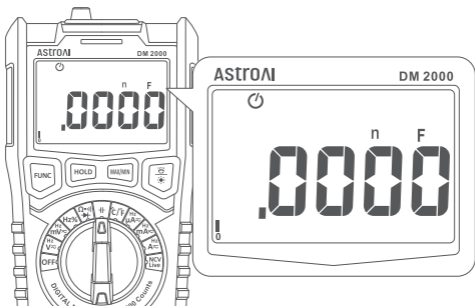

- Insert the red test lead into the “ Ω Live C/F” terminal, and the black test lead into the “COM” terminal.

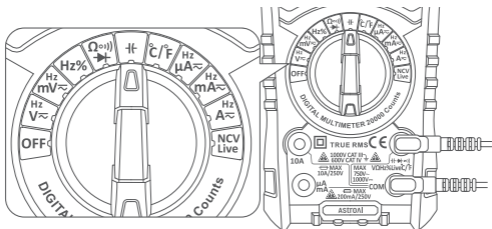

- Connect the test leads to the capacitor to be tested.
- Record the stabilized reading from the screen.

Continuity Measurement

- Turn the rotary dial to the “ Ω ” setting. Press the “FUNC” button to choose the continuity function and power off the circuit.

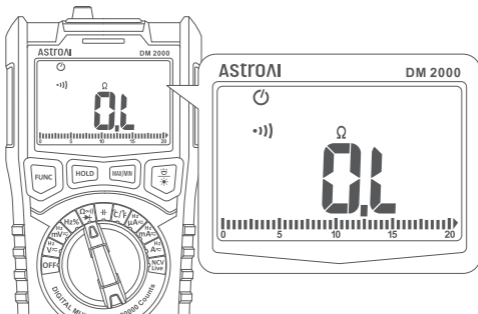

- Insert the red test lead into the “ Ω Hz%LiveC/F” terminal, and the black test lead into the “COM” terminal.

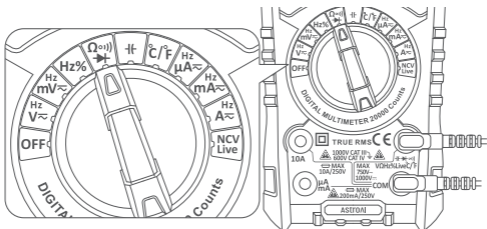

- Connect the test leads to the circuit or the resistance to be tested.
- If the resistance of the resistor/load is $<30 \Omega$, the LED light will illuminate green and the buzzer will beep. If the resistance is between 30Ω - 60Ω , the screen will display the resistance value.

Diode Measurement

- Turn the rotary dial to the “ \rightarrow ” setting. Press the “FUNC” Button to choose the diode function; then power off the circuit being tested.

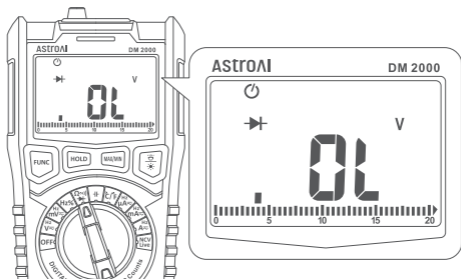

2. Insert the red test lead into the “ Ω Hz%LiveC/F” terminal and the black test lead into the “COM” terminal.

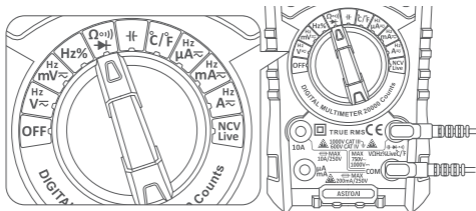

3. Use the red test lead to touch the positive polarity of the diode and the black test lead to touch the negative polarity of the diode.
4. Record the stabilized reading from the screen.
5. If the test leads are connected reversely, the “OL” symbol will be displayed on the LCD screen. This can be used to help distinguish the anode and cathode.

NCV Detection

1. Turn the rotary dial to the “NCV Live” setting and press the “FUNC” Button to choose the NCV function, the screen will display the “NCV” symbol.

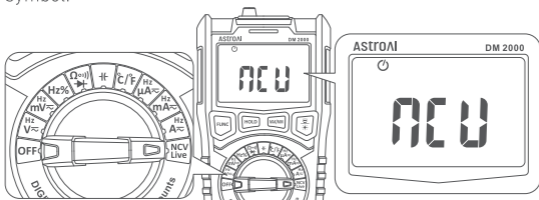

2. Move the NCV detector close to the point to be tested.
3. When the meter senses a weak AC signal, the green indicator light will turn on and the buzzer will emit a slow, audible beep.
4. When the meter senses a strong AC signal, the red indicator light will turn on and the buzzer will emit a rapid beep.

Live Wire Detection

1. Turn the rotary dial to the "NCV Live" setting and press the "FUNC" Button to choose the LIVE function, the screen will display the "Live" symbol.

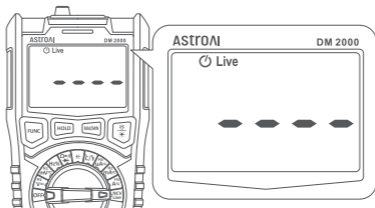

2. Insert the red test lead into the " $\text{V}\Omega\text{Hz}\% \text{Live} \text{C}/\text{F}$ " terminal, and touch the point to be measured with the tip of the red test lead.

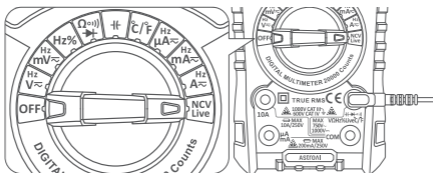

3. When the meter senses a strong AC signal, the red indicator will turn on, the "LIVE" symbol will display on the orange screen and the buzzer will emit a rapid beep.

Temperature Measurement

1. Turn the rotary dial to the "°C/°F" setting.

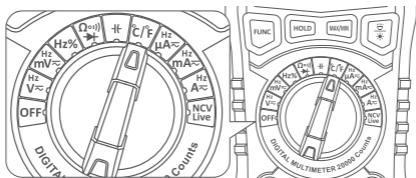

2. Insert the positive polarity (red) of the K-type thermocouple into the "VΩHz%LiveC/F" terminal, and the negative polarity (black) into the COM terminal.

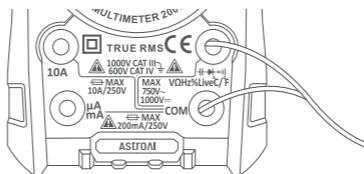

3. Touch the end of the K-type thermocouple to the object being measured. Record the result on the screen.

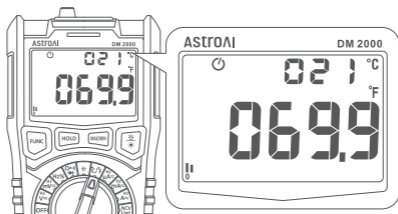

4. The screen will display Fahrenheit and Celsius degrees.

Note:

- The cold junction of the K-type thermocouple takes time to reach thermal equilibrium.
- Use the K-type thermocouple only.

Warning:

When using the K-type thermocouple to test temperature, do not touch it with electric objects; doing so may damage the meter and cause an electric shock or personal injuries.

MAINTENANCE

Cleaning

If there is dust or humidity in the terminals, it may produce erroneous measurements. Please clean the meter as follows:

- Turn off the power to the meter and remove the test leads.
- Turn the meter over and shake out the dust accumulated in the input jack. Then, wipe the case with a damp cloth or mild detergent. Do not use abrasive materials or solutions. Wipe the contacts in each terminal with a clean cotton swab dampened in alcohol.

Warning:

Please keep the interior of the meter clean and dry in case of electric shock or damage.

Replacing Battery

1. Turn off the meter and remove the test leads.

2. Unscrew the screws and open the back case.
3. Remove the old batteries and install the new batteries according to the polarity marks inside the battery compartment.
4. Fasten the battery cover and screws after installing the batteries.

Warning:

- Please replace the battery when the low battery symbol appears on the screen to avoid inaccurate readings and electric shocks or personal injuries.
- To ensure safe operation, please take the batteries out of the meter if it is going to be idle for a long time. Failure to do so may cause leaky batteries that damage the meter's internals.

Replacing Fuses

1. Turn off the meter and remove the test leads.
2. Unscrew the screws and open the back case.
3. Remove the blown fuses, and replace them with fuses of the same specification. Ensure the fuses are installed well.
4. Fasten the cover and screws after installing the fuses.

It is crucial that the replacement fuses have the same rating:

- mA: F200 mA/250 V fuse, Φ 6x32 mm.
- 10A: F10 A/250 V fuse, Φ 6x32 mm.

Warning:

To avoid electric shock, personal injuries or damage to the meter, please use fuses with the same specifications.

SPECIFICATIONS

- Work Environment: CAT. IV 600 V; CAT. III 1000 V;
Pollution Level: 2;
Altitude < 2000 m;
Work Temperature & Humidity: 0~40 °C (<80% RH, <10 °C Non-Condensing);
Storage Temperature & Humidity: -10~60 °C (<70% RH, Battery removed).
- Temperature Coefficient: 0.1X Accuracy/°C (<18 °C Or >28 °C).
- The Maximum Measurable Voltage of the Meter: DC 1000 V/AC 750 V.
- Fuse Ratings:
mA: F200 mA/250 V fuse, Φ 6x32 mm;
10A: F10 A/250 V fuse, Φ 6x32 mm.
- Sampling Speed: 3 Times/Second.
- Digital Display: Automatically display unit symbols based on the current settings.
- Overload Indication: "OL".
- Range Selection: Auto.
- Low Battery Indication: "  " displays when the battery voltage is lower than normal.
- Input Polarity Indication: the " — " symbol displays automatically.
- Power: 2x1.5 V AA batteries.

DETAILED SPECIFICATIONS

Precision Index:

- The accuracy is consistent within one year of calibration.
- Ambient Temperature: 18 °C to 28 °C, Relative Humidity: \leq 80%.
- Accuracy: \pm (%rdg + dgts).

DC Voltage

Range	Resolution	Accuracy
200 mV	0.01 mV	± (0.08% + 5)
2 V	0.0001 V	
20 V	0.001 V	
200 V	0.01 V	
1000 V	0.1 V	

- Input Impedance: 10 MΩ.
- Overload Protection: 1000 V DC/750 V AC.

AC Voltage

Range	Resolution	Accuracy
200 mV	0.01 mV	± (1.0% + 25)
2 V	0.0001 V	
20 V	0.001 V	
200 V	0.01 V	
750 V	0.1 V	

- Input Impedance: 10 MΩ.
- Frequency Range: 40 Hz ~ 1 kHz.
- Response: True RMS.
- Overload Protection: 1000 V DC/750 V AC.

DC Current

Range	Resolution	Accuracy
200 μA	0.01 μA	± (0.5% + 5)
2000 μA	0.1 μA	
20 mA	0.001 mA	
200 mA	0.01 mA	
10 A	0.001 A	± (1.0% + 15)

- Overload Protection: "μA/mA" Input: F200 mA/250 V Fuse;
"10 A" Input: F10 A/250 V Fuse.

- Maximum Measuring Current: "µA/mA" Terminal Maximum Input: 200 mA;
"10 A" Terminal Maximum Input: 10 A.
- Do not continuously test a current >1 A for more than 30 seconds.
Allow the meter to cool down for 1 minute before resuming use.

AC Current

Range	Resolution	Accuracy
200 µA	0.01 µA	± (1.0% + 25)
2000 µA	0.1 µA	
20 mA	0.001 mA	
200 mA	0.01 mA	
10 A	0.001 A	± (1.5% + 25)

- Overload Protection: "µA/mA" Input: F200 mA/250 V Fuse;
"A" Input: F10A/250V Fuse.
- Maximum Measuring Current: "µA/mA" Maximum Input 200 mA;
Maximum Input "A" 10 A.
- Frequency Range: 40 Hz-1 kHz; Response: True RMS.
- Do not continuously test a current >1 A for more than 30 seconds.
Allow the meter to cool down for 1 minute before resuming use.

Resistance

Range	Resolution	Accuracy
200 Ω	0.01Ω	± (1.0% + 15)
2 kΩ	0.0001 kΩ	
20 kΩ	0.001 kΩ	
200 kΩ	0.01 kΩ	
2 MΩ	0.0001 MΩ	
20 MΩ	0.001 MΩ	± (3.0% + 25)
100 MΩ	0.01 MΩ	

Overload Protection: 250 V.

Capacitance

Range	Resolution	Accuracy
2 nF	0.0001 nF	± (4.0% + 50)
20 nF	0.001 nF	
200 nF	0.01 nF	
2 μF	0.0001 μF	
20 μF	0.001 μF	
200 μF	0.01 μF	
2 mF	0.0001 mF	
20 mF	0.001 mF	

Overload Protection: 250 V.

Frequency/Duty Ratio

Range	Resolution	Accuracy	Sensitivity
200 Hz	0.01 Hz	± (1.0% + 30)	100 mV(RMS)
2 kHz	0.0001 kHz		
20 kHz	0.001 kHz		
200 kHz	0.01 kHz		
2 MHz	0.0001 MHz	± (1.0% + 30)	0.8 V(RMS)
10 MHz	0.001 MHz	± (3.0% + 30)	
1-99%	0.1%	± (3.0% + 30)	

- Minimum Measuring Frequency: 5 Hz; Overload Protection: 250 V.
- Frequency in the "mV" Voltage Setting.
 - 1) Measuring Range: 10 Hz ~ 100 kHz;
 - 2) Signal Sensitivity: >10 mV RMS, Sine Wave.
- Frequency in the "V" Voltage Setting.
 - 1) Measuring Range: 10 Hz ~ 20 kHz;
 - 2) Signal Sensitivity: >0.5 V RMS, Sine Wave.

- Frequency in the Current Setting.
 - 1) Measuring Range: 10 Hz ~ 20 kHz;
 - 2) Signal Sensitivity: "μA" Setting: >100 μA RMS, Sine Wave;
 "mA" Setting: >10 mA RMS, Sine Wave;
 "A" Setting: >1A RMS, Sine Wave.

Temperature

Range	Resolution	Accuracy	
°C	0.1 °C	-40 °C ~ 0 °C	± 3 °C
		0 °C ~ 400 °C	+ (1.0% + 2 °C)
		400 °C ~ 1000 °C	± 2.0%
°F	1 °F	-40 °F ~ 32 °F	± 6 °F
		32 °F ~ 752 °F	± (1.0% + 4 °F)
		752 °F ~ 1832 °F	± 2.0%

The accuracy above does not include the error margin of the thermocouple's tip.

Continuity Test

Range	Function	
o1))	The buzzer inside the meter will beep and the indicator will turn green if the resistance is <30 Ω. If the resistance is greater than 30 Ω or smaller than 60 Ω, the buzzer will not beep and the indicator will turn red.	<ul style="list-style-type: none"> • Measuring Voltage: Around 1 V. • Overload Protection: 250 V.

Diode Test

Range	Function
	<p>The approximate diode forward voltage value will be displayed</p> <ul style="list-style-type: none">• Maximum Measuring Current: Around 1.2 mA.• Maximum Measuring Voltage: Around 3.0 V.• Overload Protection: 250 V.

RECYCLING

You may dispose of the product when its service life has ended, please recycle the recyclable parts according to local guidelines.

WARRANTY PERIOD

3-year Limited Warranty From AstroAI.

Each AstroAI Digital Multimeter will be free from defects in material and workmanship. This warranty does not cover fuses, disposable batteries and damage from neglect, misuse, contamination, alteration, accident, or abnormal conditions of operation or handling, including overvoltage failures caused by use outside the Multimeter's specified rating, or normal wear and tear of mechanical components. This warranty covers the original purchaser only and is not transferable.

If this product is defective, please contact AstroAI customer support at support@astroai.com

AstroAI

Web: www.astroai.com

E-mail: support@astroai.com

封面

封底

AstroAI

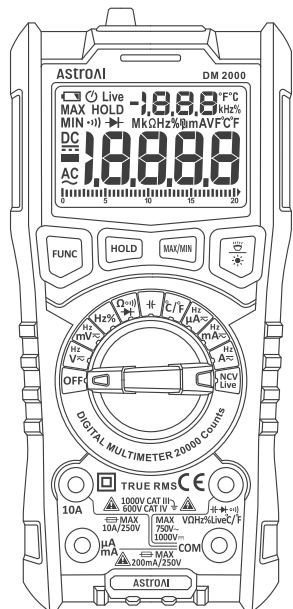

DM2000

TRUE RMS DIGITAL MULTIMETER
USER MANUAL

EN

AstroAI

Web: www.astroai.com

E-mail: support@astroai.com

AstroAI

重庆麦一科技有限公司
Chongqing Maiyi Technology Co., Ltd.

本设计图纸版权归本公司所有，未经本公司书面同意不得复印。

本图纸应与说明，产品状况，产品结构图及有
关图纸协调使用，发现任何差异请立即通知设计师。

图档中所有尺寸比例为1:1。
公差: L(长)*(宽): +1/-1mm, H(高): ±1mm

项目信息

产品名称	万用表M20RD
物料类型	说明书
物料版本	V1.0
更新说明	

技术规格

尺寸规格	90*130mm
印刷颜色	PANTONE 1585C + K
物料材质	封面封底潘通彩印 内页单色印刷 80g双胶
后道工艺	骑马钉

1. 印刷内容、字体、字体颜色（和文档一致）符合要求
2. 表面整洁平整，无褶皱破损、无污渍杂质、无划痕
3. 字体、图案应清晰、正确、无错印、漏印，无油墨污染

设计人员	Yanis
设计日期	2023.3.16
产品对接	Daniel / Victor
翻译对接	