

# Edge Computing Gateway

## EG8200Mini

### Quick Start Instructions



## Directory

<b>1、 Power supply and connection</b> .....	4
1. Power supply and indicator status.....	4
2. Ethernet connection/WiFi connection.....	4
<b>2、 Basic use</b> .....	5
1. Login screen.....	5
2. DIY configuration.....	6
3. System Information.....	7
4. WWAN (4G) attributes.....	10
5. WiFi configuration.....	11
6. WAN configuration.....	12
7. LAN configuration.....	13
8. Senior.....	13
9. Visual programming.....	15
10. Instructions for using nodes.....	15
<b>3、 Visual programming – process import and export</b> .....	16
1. Process import.....	16
1.1 Enter the import function page.....	16
1.2 Select the process and import it.....	17
1.3 Deployment process.....	18
2. YuQue case import.....	18

2.1.	Enter the import function page.....	19
2.2.	Select the case of the squeak.....	19
2.3.	Import a case .....	20
2.4.	Deployment Cases.....	21
3.	Process export .....	22
3.1.	Enter the export page .....	22
3.2.	Select the process and export.....	23
<b>4.</b>	<b>Remote management (instructions for using IOTClient).....</b>	<b>23</b>
1.	Software download and installation .....	23
2.	Account login.....	24
3.	Add a device .....	24
4.	Group management.....	26
5.	Device sharing .....	27
6.	Remote configuration and programming .....	27
7.	Intranet penetration .....	29

# 1、 Power supply and connection

## 1. Power supply and indicator status

Use DC12V to connect to the power supply terminal of the device, and you will see the power indicator solid after powering on.

Name	Function	State	Status description
POW	Power indicator	Always extinguished	The power supply is abnormal
		Solid on	The power supply is normal
RUN	System working status indicator	Always extinguished	The internal program is not running
		600ms on/600ms off	The program is running, but it is not connected to the Internet (the Internet address is the configured detection address)
		100ms on/2800ms off	Run the program and connect to the Internet
4G	Module status indicator	200ms on/1800ms off	Find the network status
		1800ms on/200ms off	Standby state
		125ms on/125ms off	Data transfer mode
WIFI	STATION connection status indicator	Always extinguished	Disabled state
		Solid on	Enabled state, connected to an external hotspot
		flashing	Enabled state, not connected to an external hotspot
LED1-2	Customize the indicator	0	Always extinguished
		1	Solid on
		2	Slow flashing
		3	Flashing rapidly

## 2. Ethernet connection/WiFi connection

- Connect the computer network port to the LAN port of the device with an Ethernet cable,

and the default IP address of the LAN port of the device is 192.168.88.1. The configuration needs to set the LAN port IP of the computer and the device to the same IP address range, otherwise the device and the computer cannot communicate. As shown in the figure below:

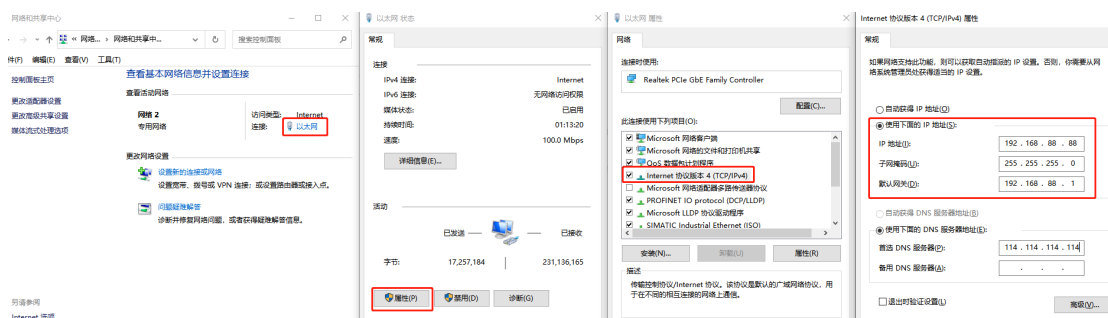

- The computer connects to the hotspot of the device through the WiFi function, WiFi name: (device model - 4 digits after the SN tail number), password: EG12345678, the default IP of WiFi is 192.168.88.1 (the same as the IP of LAN), as shown in the figure:



## 2、Basic use

### 1. Login screen

Open your browser and type 192.168.88.1 in the address bar, enter the login interface, and manage the default password EG12345678 (you can change it yourself after logging

in).

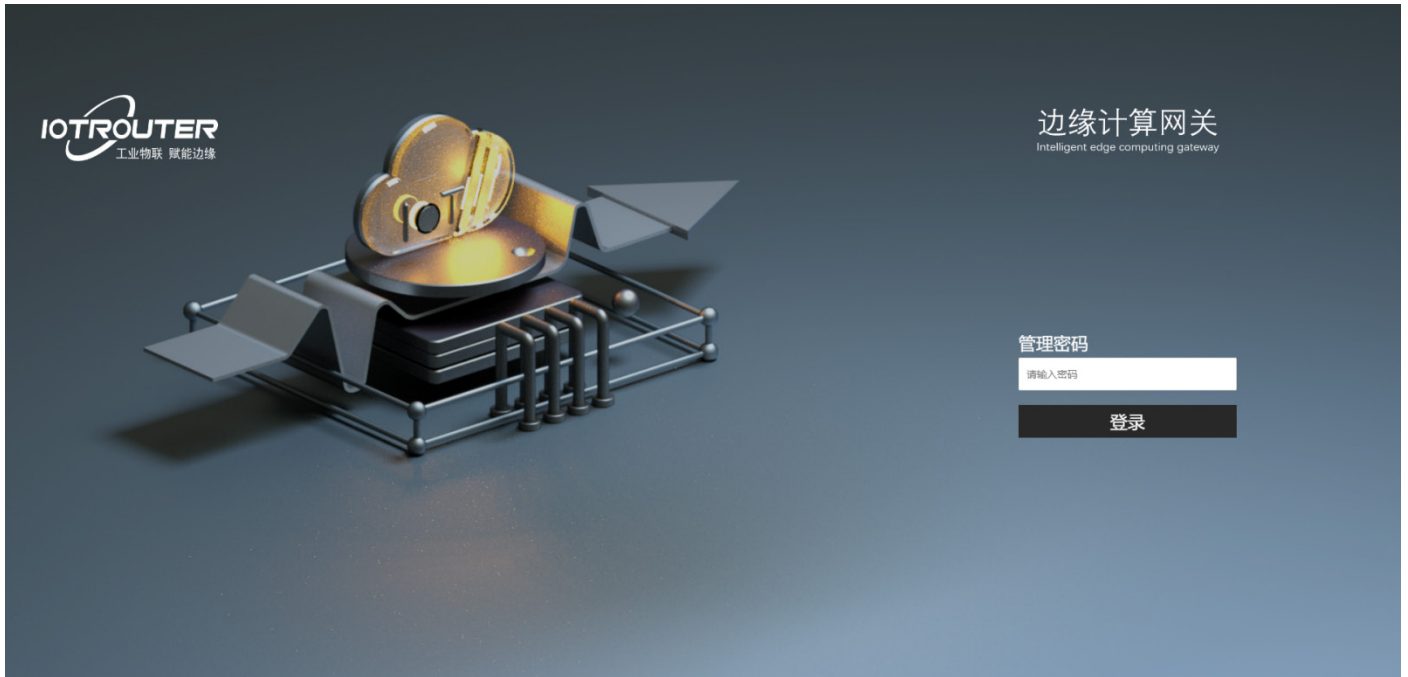

- Manage password: Enter the management password EG12345678 enter the device management page.

## 2. DIY configuration

After logging in to the configuration page, you can enter the device access IP: 192.168.88.1/DIY to enter the device DIY configuration page.

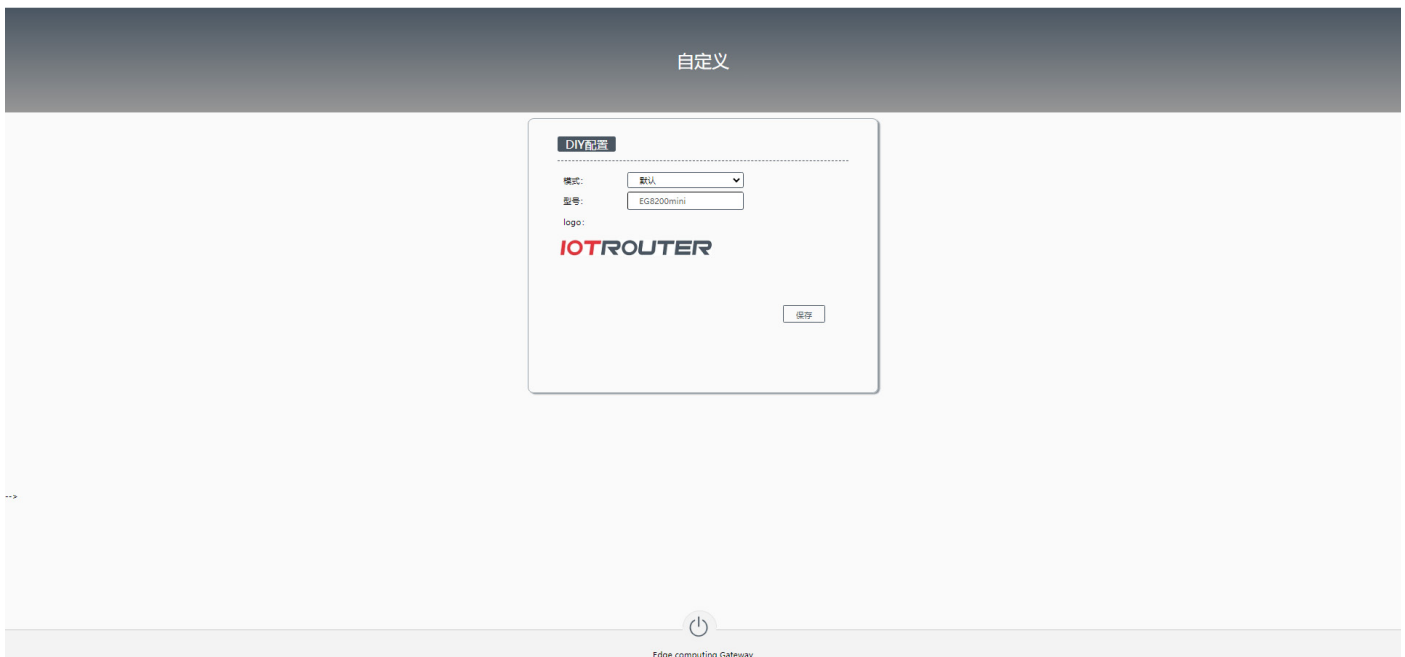

- Default: Mode factory default, model (EG8200Mini)/LOGO (IOTROUTER).
- Neutral: model (IOT8200Mini), without LOGO.
- Customization: The model is customized, and the LOGO can be customized and uploaded, and it will be saved and effective after modification.

### 3. System Information

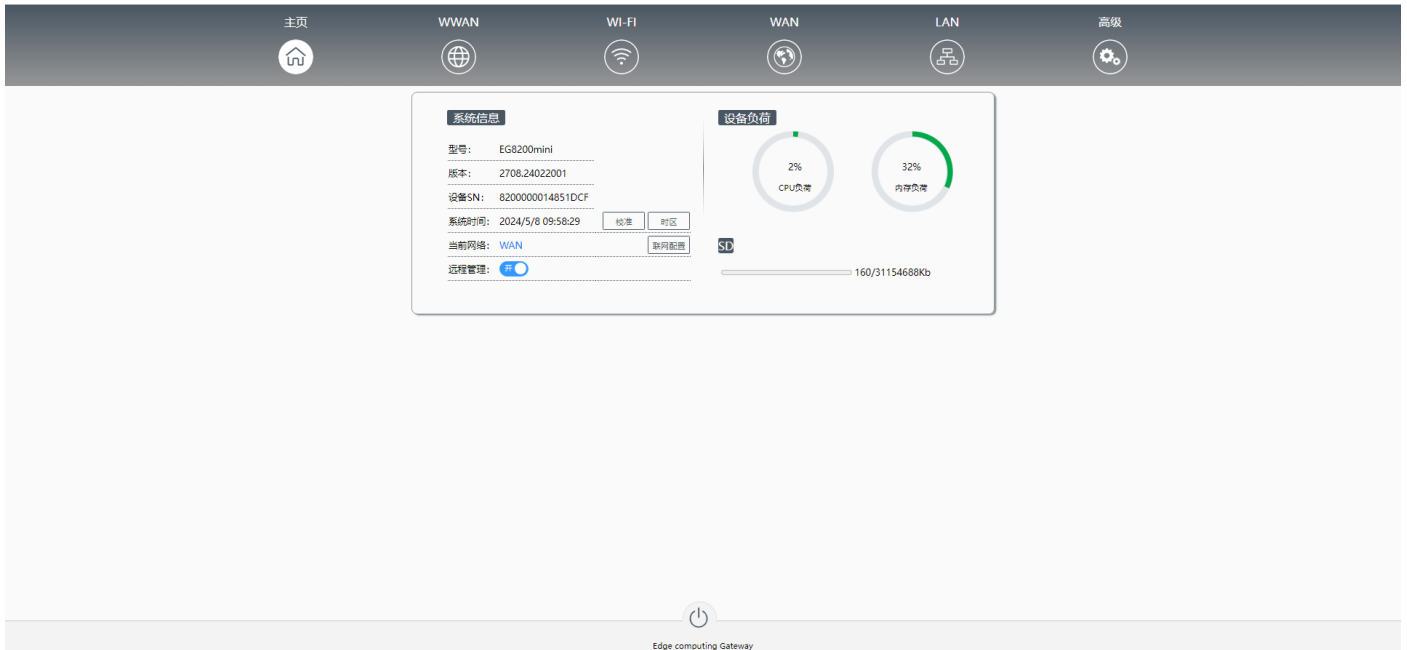

- Model: EG8200Mini (Note: Any configuration modification on the homepage will take effect if the reboot takes effect).
- Version: 2708.24022001 (version has updated iterations).

- Device SN: the unique number of the device, which is required for remote management.
- System time: RTC clock, click Calibration, time zone customization (default East 8 area).
- Networking mode: default AUTO (automatically switch the networking mode according to the network environment), and at the same time, the priority networking order is WAN/WiFi/WWAN (4G), and the other options are fixed for a certain mode of networking.
- Sniffing function: Ping the default sniffing address (the address and period can be modified according to your own situation), determine the current network status, and automatically switch the network mode (AUTO), and if the network mode is fixed, the sniffing function is replay and reconnection.
- Remote management: used for remote access to configure the device, if there are special requirements, you can turn off it by yourself (Note: after turning off remote management, remote configuration will not be possible, and all consequences will be borne by yourself).
- SD: Displays the memory card storage space usage (Note: The card needs to be disassembled from the case).

## 4. WWAN (4G) attributes

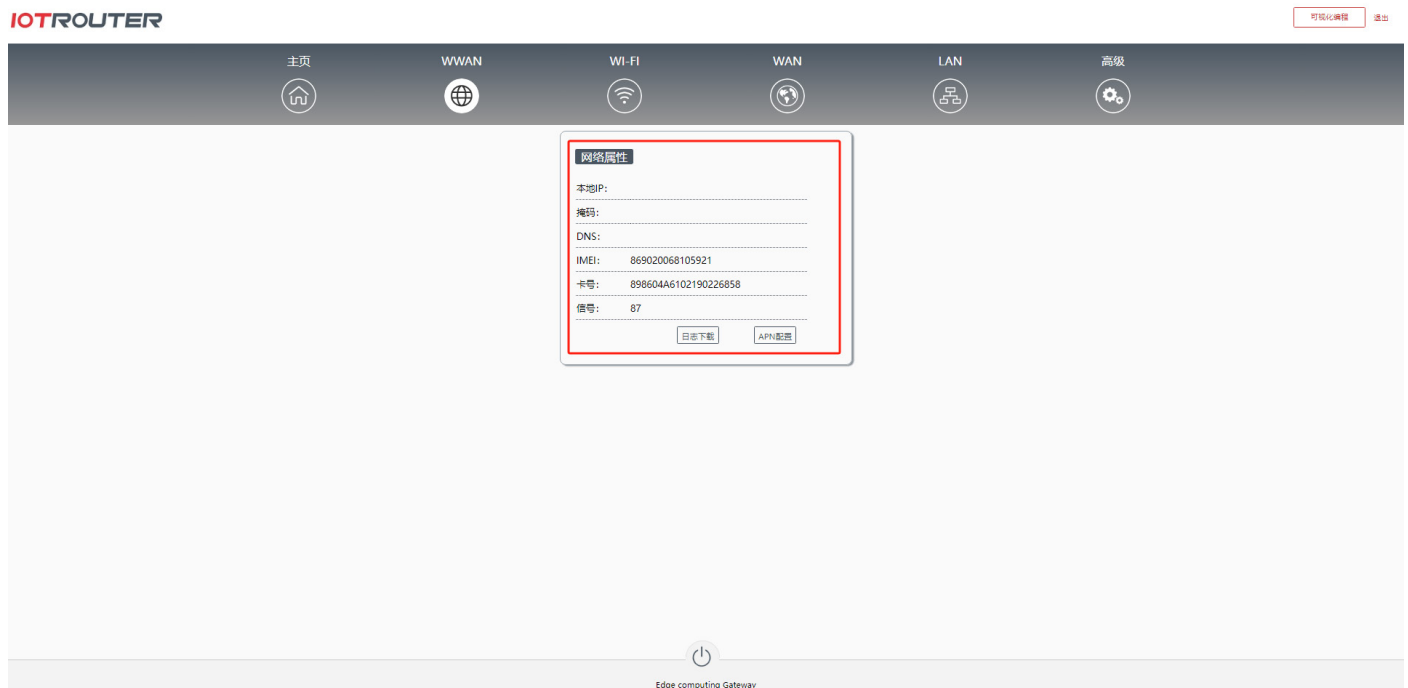

- Local IP: The IP address that is automatically obtained by the cellular network.
- Mask: Automatically generated.
- DNS: Base Station Allocation.
- IMEI: the IMEI number of the cellular module.
- Card number: SIM card number.
- Signal: The current signal strength (range 0-100, the higher the value, the stronger the signal).
- Log download: You can download the dial-up log of the latest 4G module.
- APN: APN settings are supported, click APN Configuration to enter the APN Settings page.

## 5. WiFi configuration



- Mode: AP mode is used to create a Wi-Fi hotspot that allows other devices to connect to it; STATION mode (manually enabled by default, only the 2.4GHz band is supported) is used for the device to connect to an existing Wi-Fi network.
- AP-WiFi name: a combination of numbers, letters, and symbols, up to 32 characters (the default is Device Model - 4 digits after SN tail number).
- AP-WiFi Password: A combination of numbers, letters, and symbols, at least 8 characters.
- STATION - Connection Name: Manually enter the name of the connected hotspot.
- STATION - Connection Password: Manually enter the password of the connected hotspot.

- STATION - IP mode: DHCP (automatically obtain IP) / static (manually set IP).

Note: The AP hotspot needs to enable the DHCP service of the LAN before the device can assign IPs to other devices connected to the hotspot.

## 6. WAN configuration

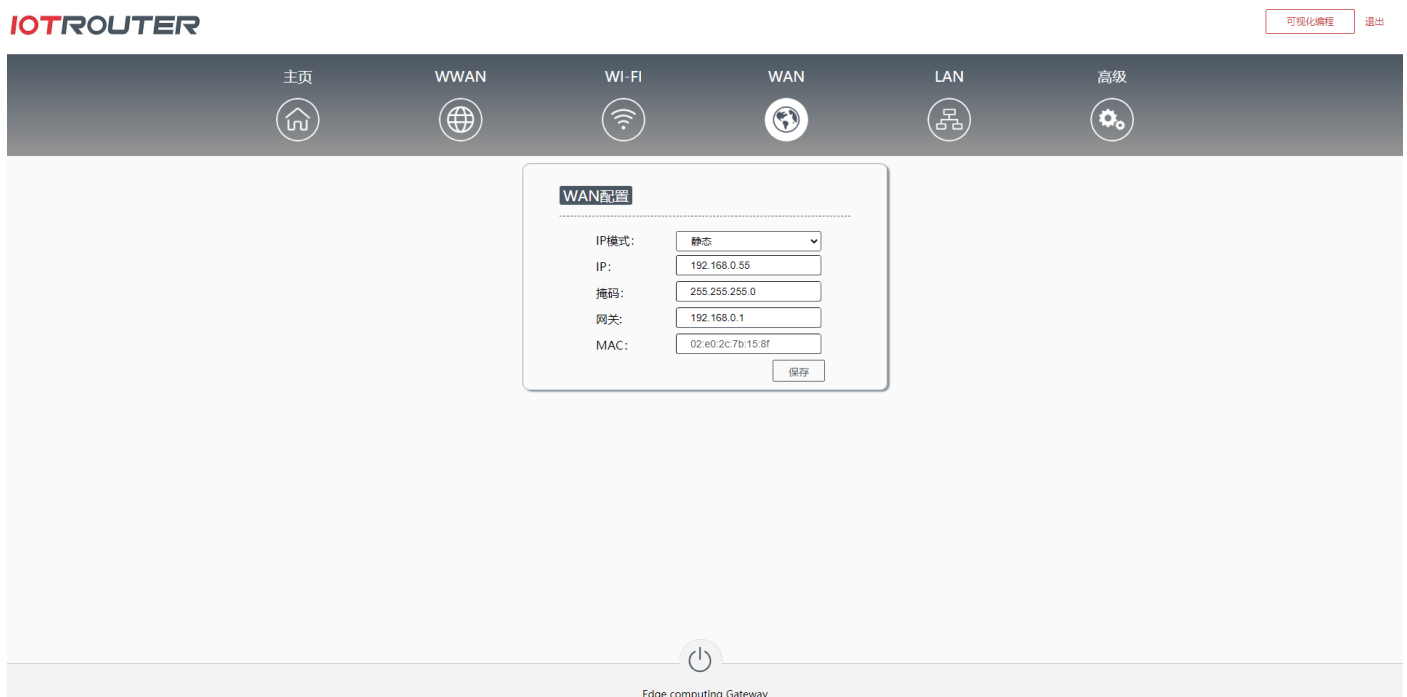

- IP Mode: Default DHCP.
- Static mode: You need to set the IP address you want to fix, and click Save to restart to take effect.
- MAC: MAC address of the WAN port.

## 7. LAN configuration



- IP: Default 192.168.88.1 (you can change it by logging in to the configuration page).
- Mask: Automatically generated.
- Gateway: Not set by default.
- MAC: MAC address of the LAN port.
- DHCP service: You can set a DHCP pool (shared WiFi and LAN) for external network supply, and set the save and restart to take effect.

## 8. Senior



- Administrator Password: Change the login password.
- Factory reset: Restore to the factory configuration of the device, or reset it through the RESET button.
- Static route: Set a specified IP address for cross-CIDR block access [the YuQue Documentation](#) (Click to jump).
- DNS: domain name resolution, you can modify the DNS server by yourself.
- NTP: The time of the NTP server is synchronized with the network, and the NTP server with the \* sign is preferred, and the private network can change the \* address by itself.
- Visual Programming: Click Visual Programming to enter the programming interface of the device.

## 9. Visual programming

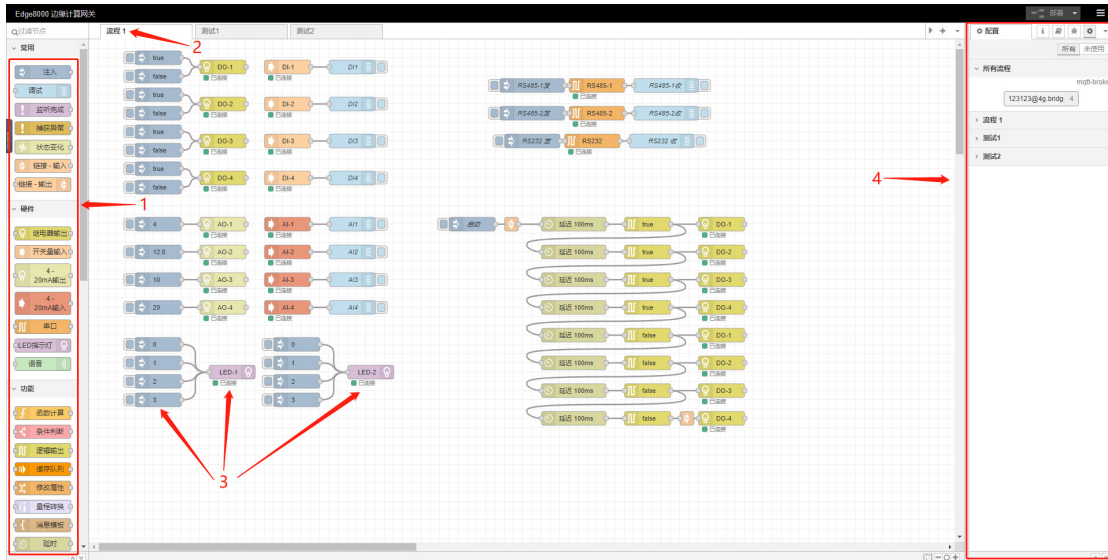

- 1: Functional node
- 2: Process tab
- 3: node
- 4: Sidebar

## 10. Instructions for using nodes

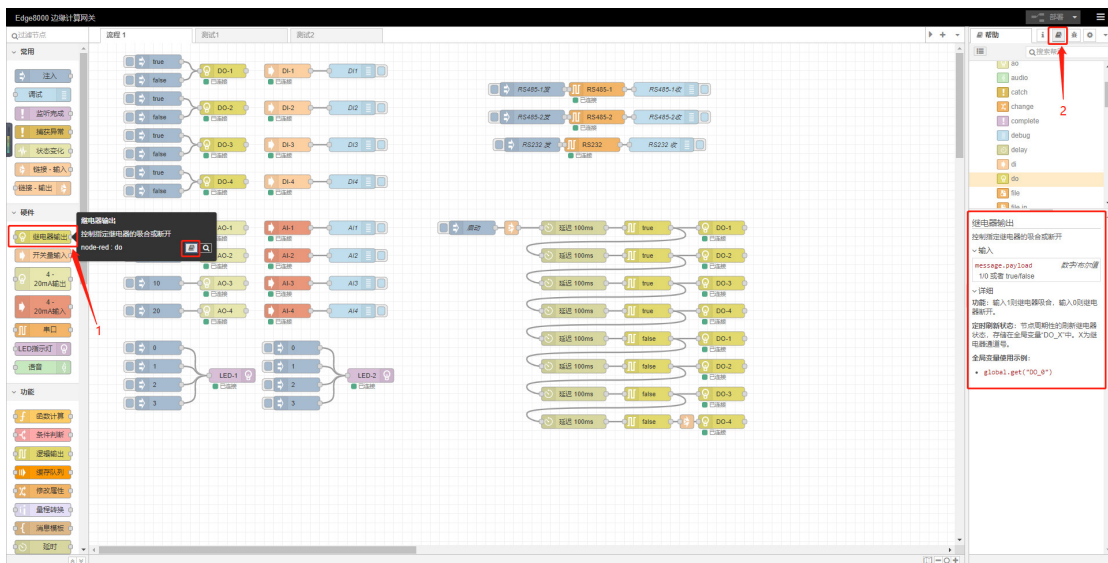

- 1: Click the node
- 2: Click Help to view the corresponding instructions of the node
- 3: For more detailed introduction of nodes, please refer to [the YuQue Documentation](#) (click to jump).

### 3、 Visual programming – process import and export

#### 1. Process import

##### 1.1 Enter the import function page

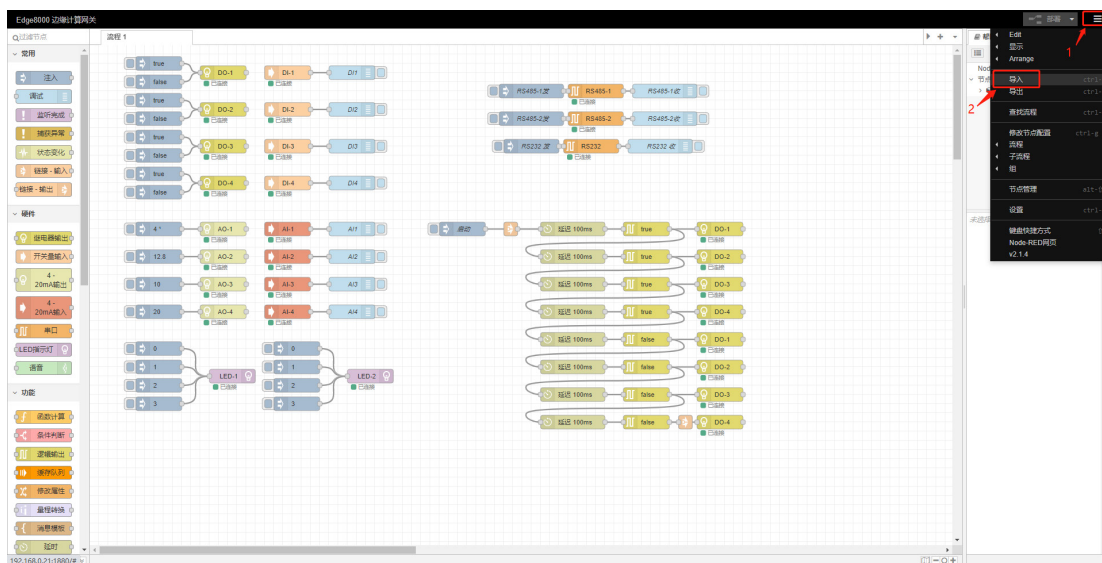

As shown above:

- 1) Click the icon in the top right corner
- 2) Click the Import button

## 1.2 Select the process and import it

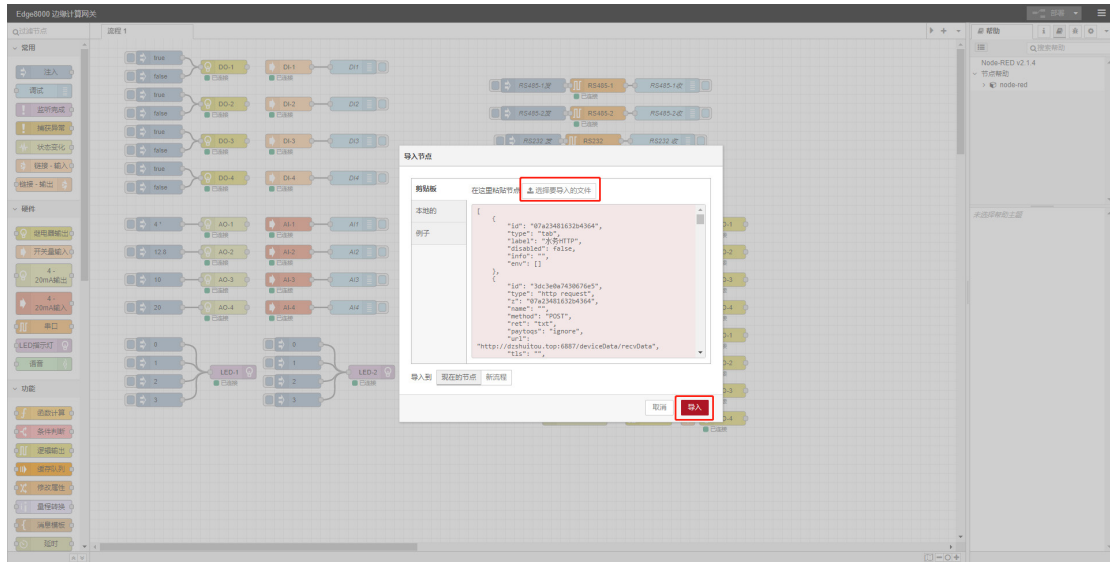

As shown above:

- 1) Select the files you want to import
- 2) Click Import

### 1.3 Deployment process

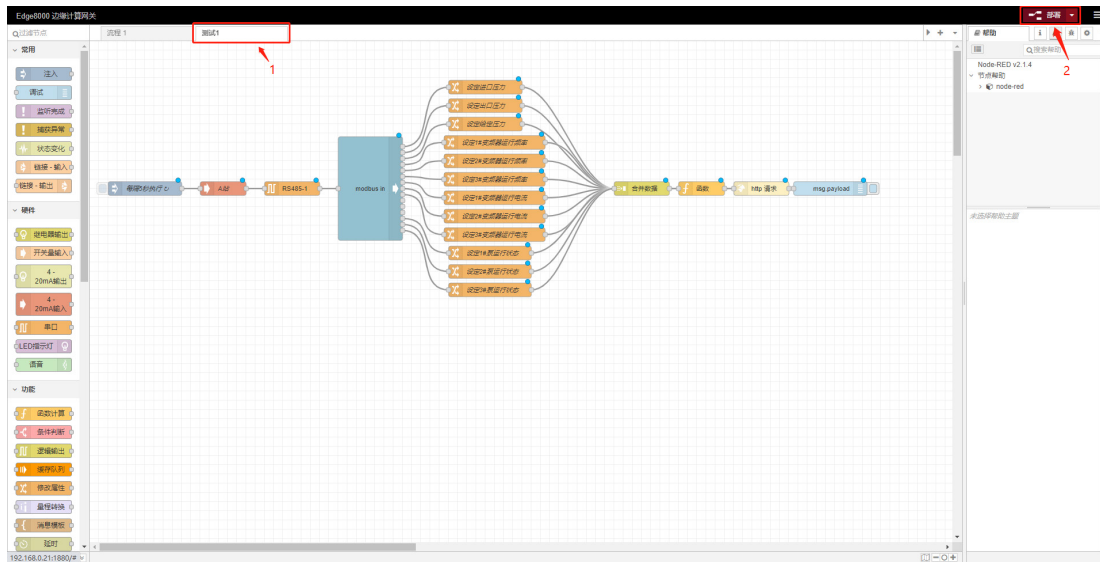

As shown above:

- 1) Test 1 is the imported process file
- 2) Click Deploy to import successfully

## 2. YuQue case import

The user guide of the gateway node and related application cases have been sorted out in [the YuQue Document](#) (click to jump), and users can select the required cases according to the classification for reference or calling, helping you build powerful applications more efficiently!

## 2.1. Enter the import function page

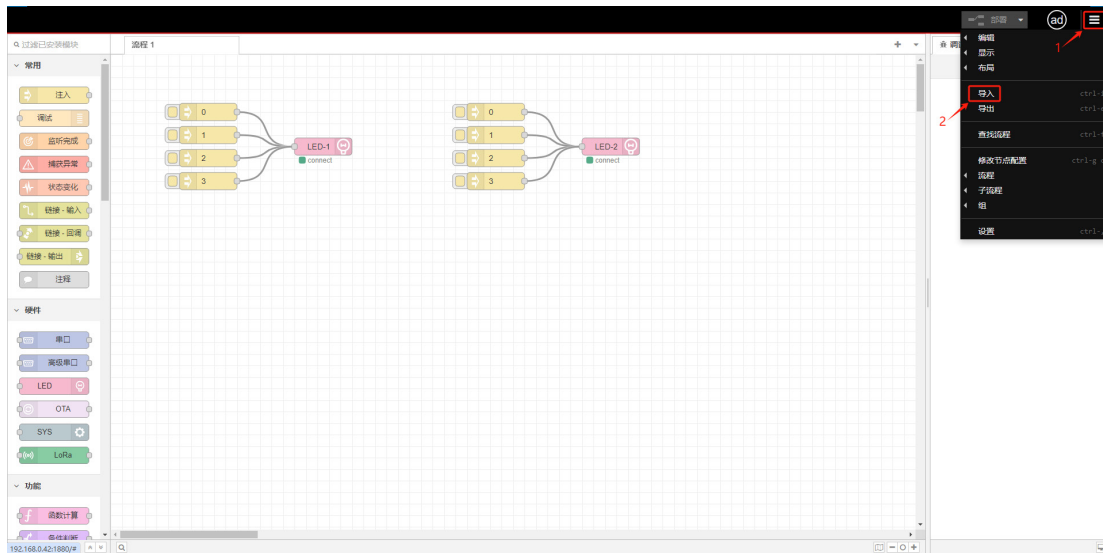

As shown above:

- 1) Click the icon in the top right corner
- 2) Click the Import button

## 2.2. Select the case of the squeak





## 2.4. Deployment Cases

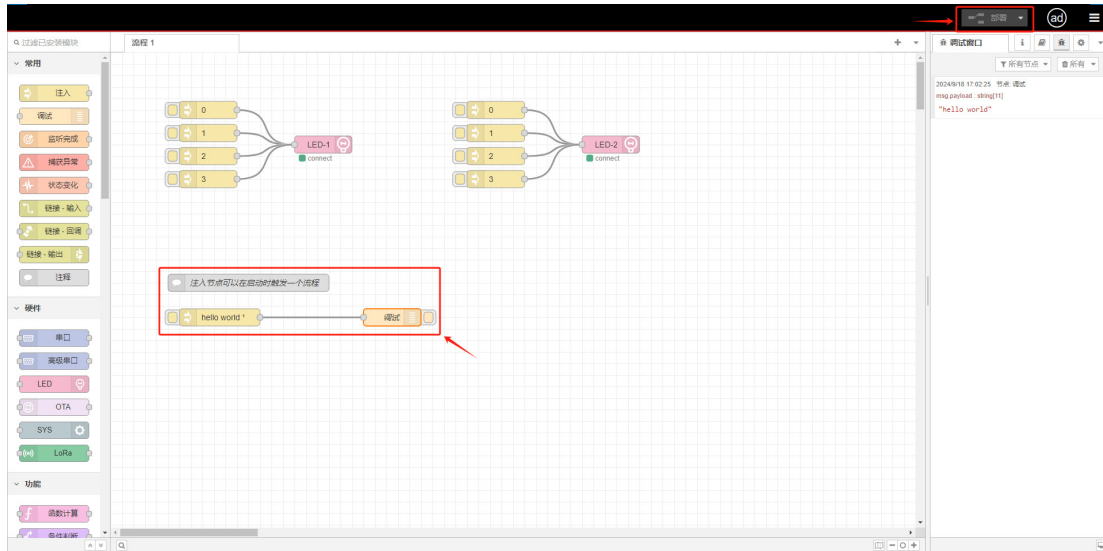

As shown above:

- 1) After importing, the story appears on the canvas
- 2) Click Deploy for the app to take effect

### 3. Process export

#### 3.1. Enter the export page

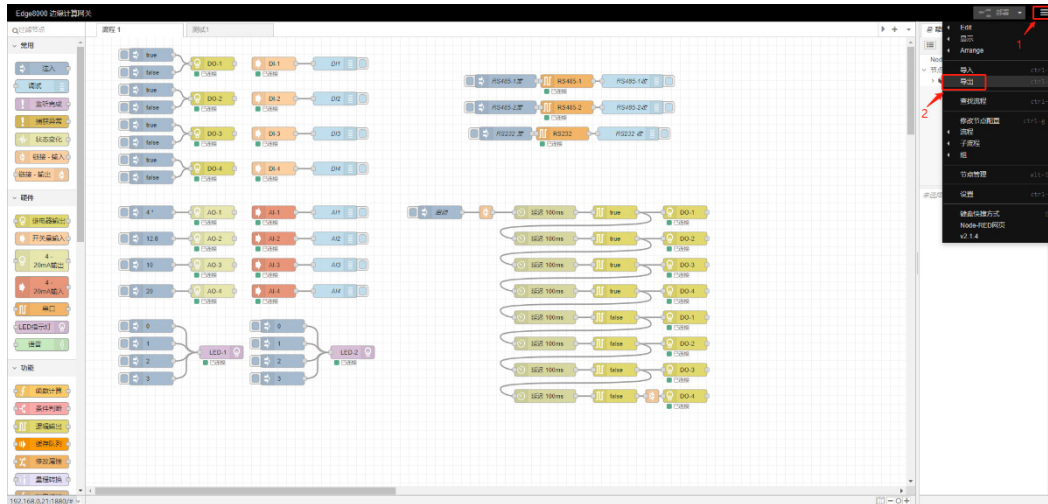

Here we take the export of "Test 1" as an example, as shown in the figure above:

- 1) Click the icon in the top right corner
- 2) Click the Export button

### 3.2. Select the process and export

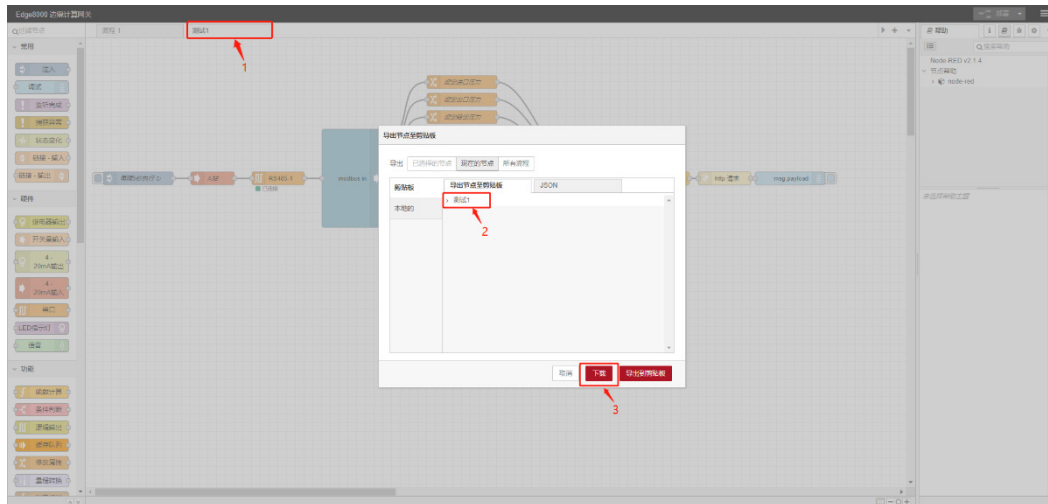

As shown above:

- 1) Select the process you want to export
- 2) Confirm that the export node is the required process
- 3) Click Download to generate the corresponding file

## 4、 Remote management (instructions for using IOTClient)

### 1. Software download and installation

Go to the website <https://www.iotrouter.com/product/> and click "Data Download" to enter the download page, where you can download the remote management software of EG8200 series products.

## 2. Account login

Open the remote software and log in via SMS or account password. If a new user uses SMS to log in, the system will automatically create an account, and the password will be empty (reset).



## 3. Add a device

After logging in to the account, click Add Device in the lower left corner, where SN is viewed in the login of the device, the password is the login password of the web page, the name is a custom name, and click Finish after entering. (Each device has a unique SN and password, and after the device is bound, no one else can bind it again, unless the owner deletes the device under the corresponding account.)

IOTROUTER 1.5.1.0

搜索分组  
Search for the group...

当前分组：默认分组

SN

Q 查找 刷新 通知 用户

状态	SN	名称	型号	版本号	操作
<div style="border: 1px solid #ccc; padding: 10px; width: fit-content; margin: 0 auto;"> <p><b>添加设备</b></p> <p>SN</p> <p>设备密码</p> <p>名称</p> <p>请选择...</p> <p>取消</p> </div>					

刷新分组 新建分组 **添加** 删除 移动 分享 撤销分享

共 0 条 10条/页 首页 上一页 1/0 下一页 前往 跳转

IOTROUTER 1.5.1.0

搜索分组  
Search for the group...

当前分组：默认分组

SN

Q 查找 刷新 通知 用户

状态	SN	名称	型号	版本号	操作
<input type="checkbox"/>		A区	EG8000mini	2X10.23021401	

刷新分组 新建分组 添加 删除 移动 分享 撤销分享

共 1 条 10条/页 首页 上一页 1/1 下一页 前往 跳转

在离线状态

远程配置 远程编程 内网穿透 分享设备

## 4. Group management

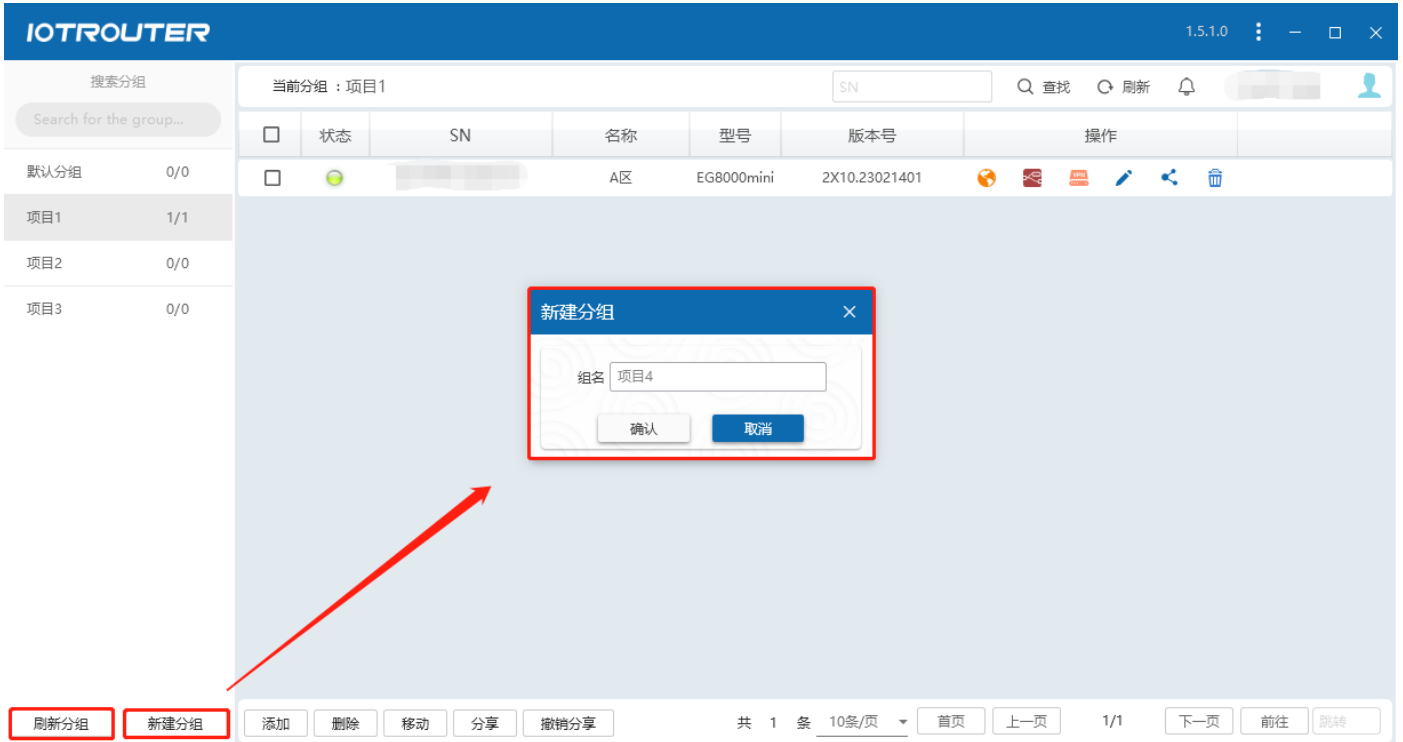

- You can create multiple groups to manage devices by group, and if the corresponding group is not refreshed on the left after the new group, you can click Refresh Group.

## 5. Device sharing

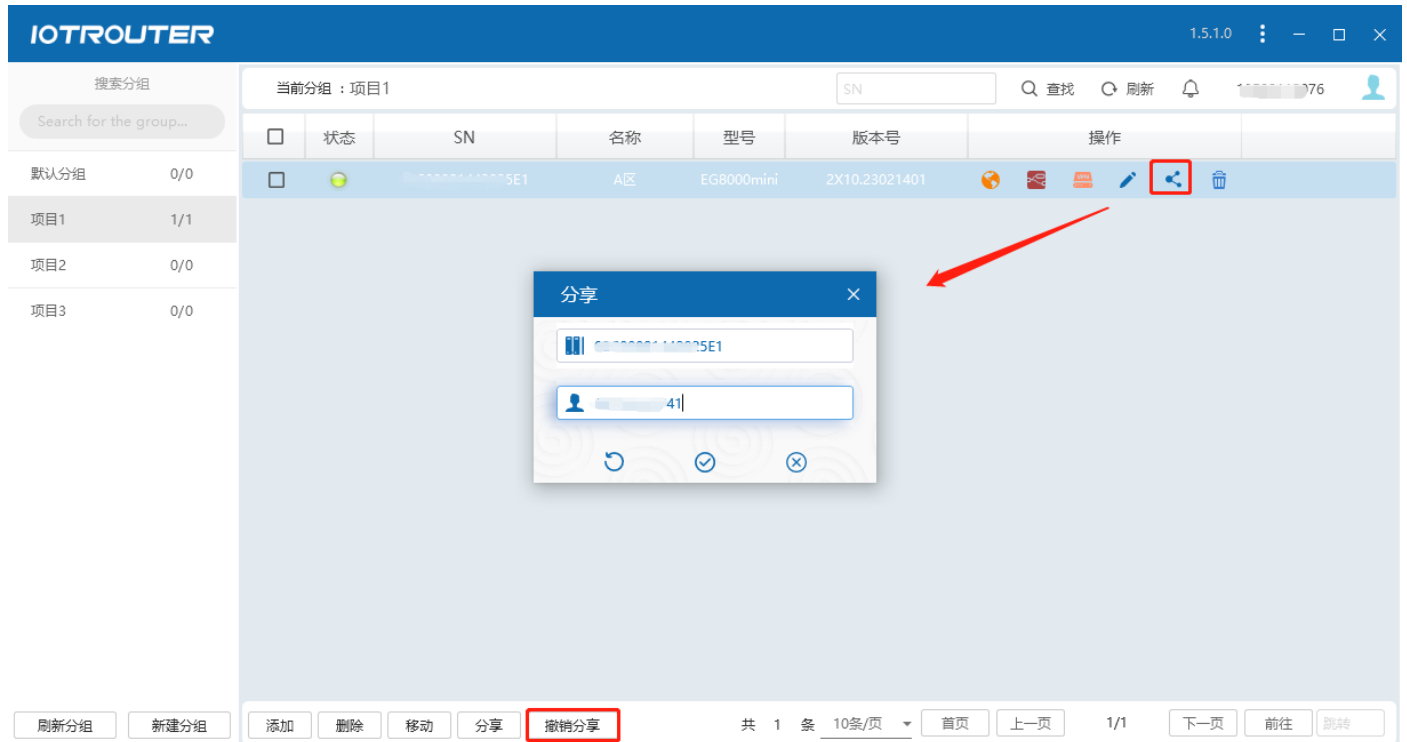

- Share the device: You can share the device added to the root account with a sub-account (a device can only be shared with one sub-account), and the sub-account can remotely configure and program the device.

## 6. Remote configuration and programming

- Remote configuration: First of all, make sure that the device is online, the status is green, and clicking on the remote configuration will automatically open the browser to jump to the web configuration interface.

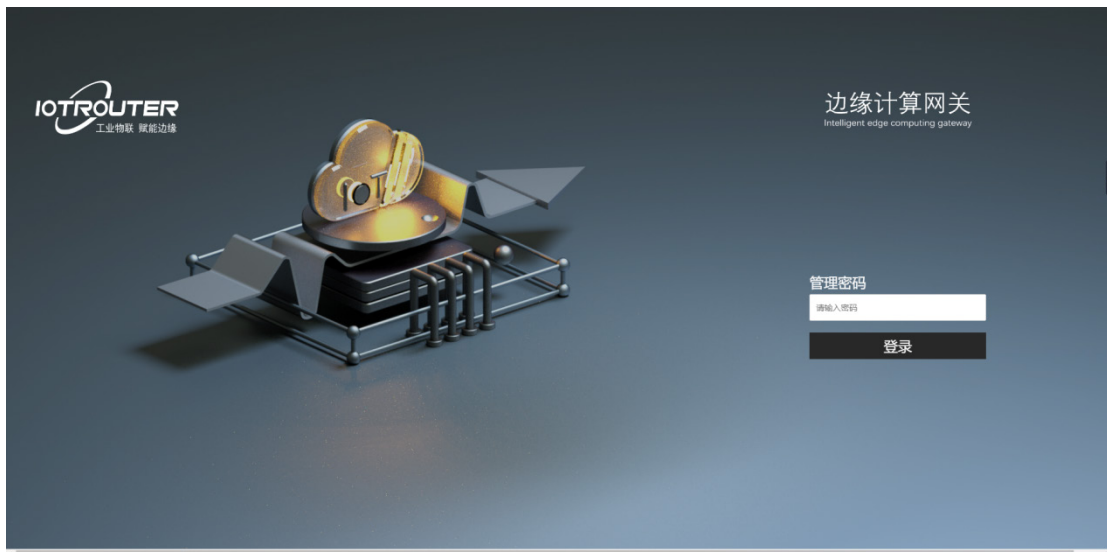
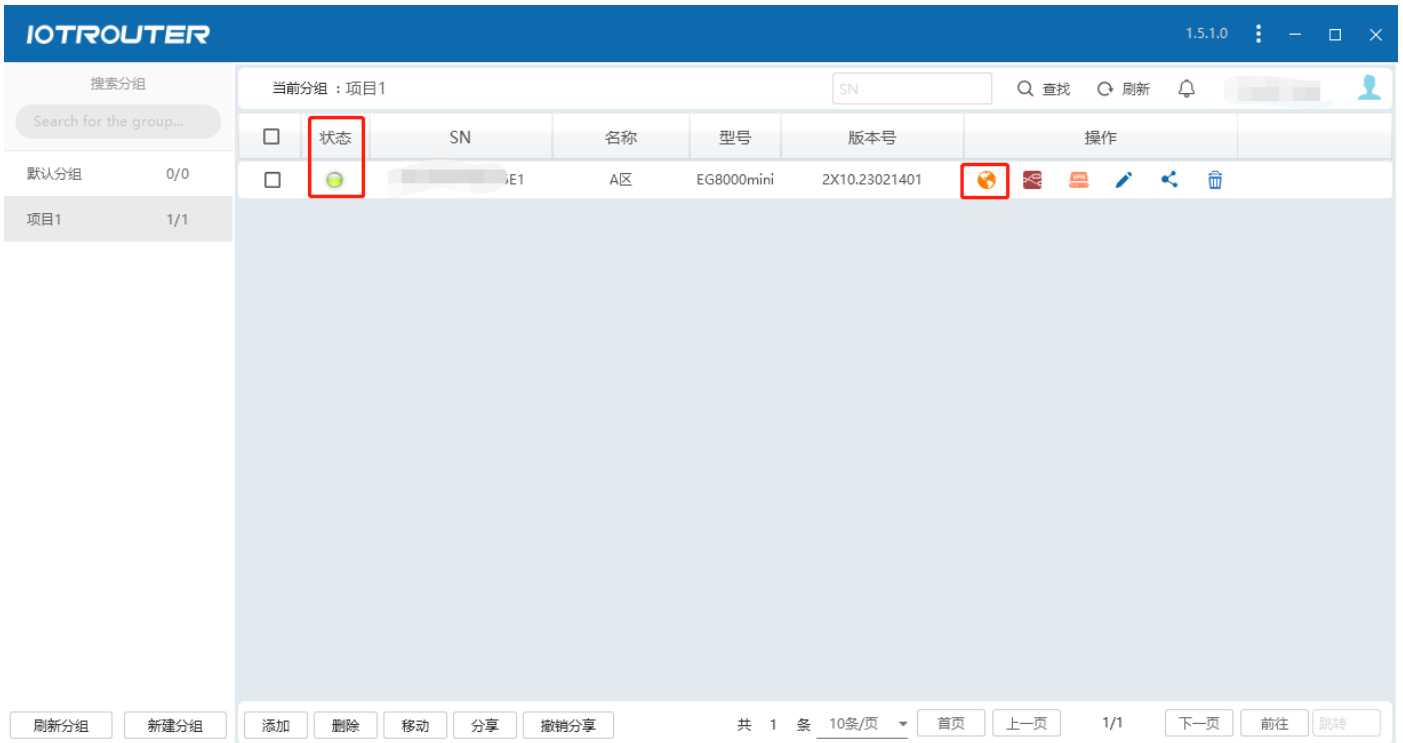

- Remote Programming: Click the remote programming button to automatically jump to the programming interface.



IP can be changed) are the same network segment.



```
Microsoft Windows [版本 10.0.19044.1586]
(c) Microsoft Corporation. 保留所有权利。

C:\Users\14771>ipconfig

Windows IP 配置

未知适配器 本地连接:

    连接特定的 DNS 后缀 . . . . . :
    本地链接 IPv6 地址. . . . . : fe80::4595:5e7f:6e87:15ba%25
    IPv4 地址 . . . . . : 192.168.88.240
    子网掩码 . . . . . : 255.255.255.0
    默认网关. . . . . : 192.168.88.1

以太网适配器 以太网:

    连接特定的 DNS 后缀 . . . . . :
    本地链接 IPv6 地址. . . . . : fe80::643a:8480:b973:6f02%10
    IPv4 地址 . . . . . : 192.168.0.15
    子网掩码 . . . . . : 255.255.255.0
    默认网关. . . . . : 192.168.0.1

C:\Users\14771>
```

If the IP is assigned successfully, the machine can directly access the LAN where the device is located. **Note: The network segment used by the computer cannot be the same as the network segment of the device, otherwise it may lead to the failure of the remote LAN.**

**IOTROUTER** 1.5.1.0

搜索分组  
Search for the group...

默认分组	0/0
项目1	1/1

当前分组：项目1

远程局域网

```
incoming Data Channel: Using 100 bit message hash SHA1 for HMAC authentication
WARNING: cipher with small block size in use, reducing reneg-bytes to 64MB to mitigate SWEET32 attacks.
interactive service msg_channel=0
ROUTE_GATEWAY 192.168.0.1/255.255.255.0 I=11 HWADDR=1c:1b:0d:7e:68:0c
open_tun
TAP-WIN32 device [本地连接] opened: \\.\Global\{0FE07B89-6918-43B3-8FD4-349CF931E09E}.tap
TAP-Windows Driver Version 9.24
Notified TAP-Windows driver to set a DHCP IP/netmask of 192.168.0.240/255.255.255.0 on interface
{0FE07B89-6918-43B3-8FD4-349CF931E09E} [DHCP-serv: 192.168.0.0, lease-time: 31536000]
Successful ARP Flush on interface [3] {0FE07B89-6918-43B3-8FD4-349CF931E09E}
MANAGEMENT: >STATE:1693362051,ASSIGN_IP,,192.168.0.240,,,,
ASSIGN_IP
TEST ROUTES: 2/2 succeeded len=2 ret=1 a=2 u/d=up
MANAGEMENT: >STATE:1693362056,ADD_ROUTES,,,,
ADD_ROUTES
C:\WINDOWS\system32\route.exe ADD 0.0.0.0 MASK 0.0.0.0 192.168.0.27
ROUTE: CreateIpForwardEntry succeeded with dwForwardMetric1=25 and dwForwardType=4
Route addition via IPAPI succeeded [adaptive]
C:\WINDOWS\system32\route.exe ADD 192.168.0.0 MASK 255.255.255.0 192.168.0.27
ROUTE: CreateIpForwardEntry succeeded with dwForwardMetric1=25 and dwForwardType=4
Route addition via IPAPI succeeded [adaptive]
WARNING: this configuration may cache passwords in memory -- use the auth-nocache option to prevent this
Initialization Sequence Completed
MANAGEMENT: >STATE:1693362056,CONNECTED,SUCCESS,192.168.0.240,139.129.229.113,17863,192.168.0.143,50830
CONNECTED
```

刷新分组 新建分组 添加 删除 移动 分享 撤销分享 共 1 条 10条/页 首页 上一页 1/1 下一页 前往 跳转

# A LEADING PROVIDER OF INTEGRATED IT AND OT PRODUCTS

**R&D Center :**

CHENGDU IOTRouter TECHNOLOGY CO., LTD  
No. 599, Section 1, Huafu Avenue, Shuangliu  
District, Chengdu city, Sichuan Province, China

**Website :**

[www.iotrouter.com](http://www.iotrouter.com)

**Mail :**

[agnes@iotrouter.com](mailto:agnes@iotrouter.com)



WhatsApp