

POWER SMART[®]

INSTRUCTION MANUAL

PORTABLE BAND SAW

Model # PS3050

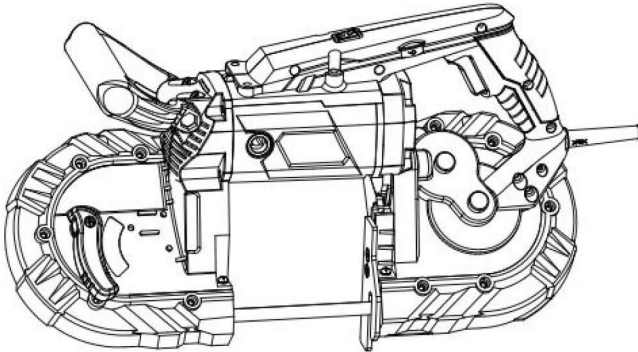

Have product questions or need technical support? Please scan the QR code to enter our official website and contact us!

Website: www.powersmartusa.com

Toll free: 1-800-791-9458 M-F 9-5 EST

Email: support@amerisuninc.com



CONTENTS

Technical data	3
Introduction	4
Safety information	4
General safety rules.....	5
Special safety rules for portable band saw.....	8
Symbols	10
Knowing your portable band saw.....	12
Assembly instruction.....	13
Operating instruction.....	14
Maintenance.....	16
Trouble shooting.....	16
Exploded view.....	17
Parts list.....	18
Warranty statement.....	20

TECHNICAL DATA

Portable band saw:	Model # PS3050
Motor:	120 V, 60 Hz,10A
No-load Speed:	0-435SFPM
Blade Dimensions:	44-7/8”(L)x1/2”(W)x0.025”(Thick)
Cutting Capacity :	5 inches
Package dimensions (L x W x H):	22.6 x7.3 x15.7 inches
Weight:	22.05 lbs

INTRODUCTION

Thank You for Purchasing a PowerSmart® Product. This manual provides information regarding the safe operation and maintenance of this product. Every effort has been made to ensure the accuracy of the information in this manual. PowerSmart® reserves the right to change this product and specifications at any time without prior notice.

Please keep this manual available to all users during the entire life of the power tool.



This manual contains special messages to bring attention to potential safety concerns, power tool damage as well as helpful operating and servicing information. Please read all the information carefully to avoid injury and machine damage.

QUESTIONS? PROBLEMS?

Please contact our Customer Service Dept. with any questions and/or comments, either by Email: support@amerisuninc.com, or Toll Free at (800)791-9458. We are available Mon-Fri 9am-5pm EST to help solve any issues that you might encounter.

SAFETY INFORMATION

Before operating this power tool, read and observe all warnings, cautions, and instructions on the power tool and in this Owner's Manual.

NOTE: The following safety information is not meant to cover all possible conditions and situations that may occur. Read the entire Owner's Manual for safety and operating instructions. Failure to follow instructions and safety information could result in serious injury or death.

This safety alert symbol is used to identify safety information about hazards that can result in personal injury.



A signal word (DANGER, WARNING, or CAUTION) is used with the alert symbol to indicate the likelihood and the potential severity of injury. In addition, a hazard symbol may be used to represent the type of hazard.

DANGER Indicates a hazard, which, if not avoided, will result in death or serious injury.

WARNING Indicates a hazard, which, if not avoided, could result in death or serious injury.

CAUTION Indicates a hazard, which, if not avoided, might result in minor or moderate injury.

CAUTION Without the alert symbol, indicates a situation that could result in damage.

GENERAL SAFETY RULES

Safety is a combination of common sense, staying alert, and knowing how your power tool works.

SAVE THESE SAFETY INSTRUCTIONS.



WARNING: Do not operate this unit until you read this instruction manual for safety, operation and maintenance instructions. Failure to follow all instructions listed below may result in electric shock, fire, and/or serious personal injury.

WORK AREA SAFETY

- Keep your work area clean and well lit. Cluttered benches and dark areas invite accidents.
- Do not operate power tools in explosive atmospheres, such as in the presence of flammable liquids, gases, or dust. Power tools create sparks which may ignite the dust or fumes.
- Keep bystanders, children, and visitors away while operating a power tool. Distractions can cause you to lose control.

ELECTRICAL SAFETY

Grounding instructions

IN THE EVENT OF A MALFUNCTION OR BREAKDOWN, grounding provides the path of least resistance for electric current and reduces the risk of electric shock. This tool is equipped with an electric cord that has an equipment grounding conductor and a grounding plug. The plug **MUST** be plugged into a matching outlet that is properly installed and grounded in accordance with **ALL** local codes and ordinances.

DO NOT MODIFY THE PLUG PROVIDED. If it will not fit the outlet, have the proper outlet installed by a licensed electrician.

IMPROPER CONNECTION of the equipment grounding conductor can result in electric shock. The conductor with the green insulation (with or without yellow stripes) is the equipment grounding conductor. If repair or replacement of the electric cord or plug is necessary, **DO NOT** connect the equipment grounding conductor to a live terminal.

CHECK with licensed electrician or service personnel if you do not completely understand the grounding instructions, or if you are not sure if the tool is properly grounded.

USE ONLY THREE-WIRE EXTENSION CORDS that have 3-pronged plugs and outlets that accept the tool's plug as shown in Fig. A. Repair or replace a damaged or worn cord immediately.

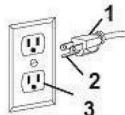

- 1 3-pronged plug
- 2 grounding prong
- 3 properly grounded outlet

CAUTION: In all cases, make certain the outlet in question is properly grounded. If you are not sure if it is, have a licensed electrician check the outlet.



WARNING: Do not expose to rain or use in damp locations.

Guidelines for using extension cords

Make sure your extension cord is in good condition. When using an extension cord, be sure to use one heavy enough to carry the current your product will draw. An undersized cord will cause a drop in line voltage resulting in loss of power and overheating. The table below shows the correct size to be used according to cord length and nameplate ampere rating. If in doubt, use the next heavier gauge. The smaller the gauge number, the heavier the cord.

Minimum Gauge for Extension Cords (AWG)
(When using 120 V only)

Ampere Rating		Total Length of Cord in feet			
More Than	Not More Than	25	50	100	150
0	6	18	16	16	14
6	10	18	16	14	12
10	12	16	16	14	12
12	16	14	12	Not Recommended	

Make sure your extension cord is properly wired and in good condition. Always replace a damaged extension cord or have it repaired by a qualified person before using it.

Protect your extension cords from sharp objects, excessive heat and damp or wet areas.

Use a separate electrical circuit for your tools. This circuit must not be less than a #12 wire and should be protected with a 15 A time-delayed fuse. Before connecting the motor to the power line, make sure the switch is in the OFF position and the electric current is rated the same as the current stamped on the motor nameplate. Running at a lower voltage will damage the motor.



WARNING: This tool must be grounded while in use to protect the operator from electric shock.

PERSONAL SAFETY

- Stay alert, watch what you are doing and use common sense when operating the tool. Do not use the tool while you are tired or under the influence of drugs, alcohol or medication. A moment of inattention while operating tools may result in serious personal injury.
- Use safety equipment. Always wear eye protection. Dust mask, non-skid safety shoes, hard hat, or hearing protection must be used for appropriate conditions.
- Dress properly. Do not wear loose clothing or jewelry. Contain long hair. Keep your hair, clothing, and gloves away from moving parts. Loose clothes, jewelry, or long hair can be caught in moving parts.

- Avoid accidental starting. Be sure switch is off before connecting to power source, pick up or carrying the tool. Carrying power tools with your finger on the switch or energizing power tools that have the switch on invites accidents.
- Do not overreach. Keep proper footing and balance at all times. Proper footing and balance enable better control of the power tool in unexpected situations.
- Do not stand on tool or its stand. Serious injury may occur if the tool is tipped or if the cutting tool is accidentally contacted. Do not store materials on or near the tool such that it is necessary to stand on the tool or its stand to reach them.

POWER TOOL USE AND CARE

- Do not force tool. Use the correct tool for your application. The correct tool will do the job better and safer at the rate for which it is designed.
- Do not use the tool if switch does not turn it on or off. Any tool that cannot be controlled with the switch is dangerous and must be repaired.
- Disconnect the plug from the power source before making any adjustments, changing accessories, or storing the tool. Such preventive safety measures reduce the risk of starting the tool accidentally.
- Inspect guards before using a tool. Keep guards in place. Check moving parts for binding or any other condition that may affect the normal operation or safety features of the tool. If damaged, have tool serviced before using the tool. Many accidents are caused by poorly maintained tools.
- Do not alter or misuse tool. Any alteration or modification is a misuse and may result in serious personal injury.
- Maintain power tools. Check for misalignment or binding of moving parts, breakage of parts and any other condition that may affect the power tool's operation. If damaged, have the power tool repaired before use. Many accidents are caused by poorly maintained power tools.
- Keep cutting tools sharp and clean. Properly maintained cutting tools with sharp cutting edges are less likely to bind and are easier to control.
- The use of any other accessories not specified in this manual may create a hazard. Accessories that may be suitable for one type of tool, may become hazardous when used on an inappropriate tool.
- Store idle power tools out of reach of children and other untrained persons. Power tools are dangerous in the hands of untrained users.
- Use the power tool, accessories and tool bits etc., in accordance with these instructions, taking into account the working conditions and the work to be performed. Use of the power tool for operations different from those intended could result in a hazardous situation.
- Save these instructions. Refer to them frequently and use them to instruct others who may use this tool. If you lend this tool to someone else, also lend them these instructions.

SERVICE

- Tool service must be performed only by qualified repair personnel. Service or maintenance performed by unqualified personnel could result in a risk of injury.
- When servicing a tool, use only identical replacement parts. Follow instructions in the Maintenance section of this manual. Use of unauthorized parts or failure to follow Maintenance Instructions may create a risk of electric shock or injury.

GENERAL

- This tool should not be used by people under the age of 16 years.

- This tool is not intended for use by persons (including children) with reduced physical, sensory or mental capabilities, or lack of experience and knowledge, unless they have been given supervision or instruction concerning use of the tool by a person responsible for their safety.

SPECIFIC SAFETY RULES FOR PORTABLE BAND SAW

- Hold power tool by insulated gripping surfaces, when performing an operation where the cutting accessory may contact hidden wiring or its own cord. Cutting accessories contacting a “live” wire may make exposed metal parts of the power tool “live” and could give the operator an electric shock.
- Never leave the Bandsaw unattended while it is running. Do not put the Bandsaw down until the blade comes to a complete stop. Moving parts can grab the surface and pull the tool out of your control.
- Before each use, make sure the tension handle is in the tightened position (making the blade taut).
- Cutting Material. Make sure cutting material is securely fastened down before operating the Bandsaw. Work slowly and carefully when cutting corners, sharp edges, ragged welds, etc., to avoid snagging.
- Cutting material and the motor housing can get very hot during operation. Stop work until unit cools down to safe temperature. Spray a coolant or water onto the blade.
- Maintain labels and nameplates on the tool. These carry important safety information. If unreadable or missing, contact Harbor Freight Tools for a replacement.
- When using a handheld power tool, maintain a firm grip on the tool with both hands to resist starting torque.
- Do not leave the tool unattended when it is plugged into an electrical outlet. Turn off the tool, and unplug it from its electrical outlet before leaving.
- This product is not a toy. Keep it out of reach of children.
- People with pacemakers should consult their physician(s) before use. Electromagnetic fields in close proximity to heart pacemaker could cause pacemaker interference or pacemaker failure. In addition, people with pacemakers should: Avoid operating alone. Do not use with power switch locked on. Properly maintain and inspect to avoid electrical shock. Any power cord must be properly grounded. Ground Fault Circuit Interrupter (GFCI) should also be implemented – it prevents sustained electrical shock.
- The warnings, precautions, and instructions discussed in this instruction manual cannot cover all possible conditions and situations that may occur. It must be understood by the operator that common sense and caution are factors which cannot be built into this product, but must be supplied by the operator.
- Keep bystanders a safe distance away from work area. Anyone entering the work area must wear personal protective equipment. Fragments of the work piece or of a broken accessory may fly away and cause injury beyond the immediate area of operation.
- Wear personal protective equipment .Depending on application, use face shield, safety goggles or safety glasses. As appropriate, wear dust mask, hearing protectors, , non-skid safety shoes,gloves and shop apron capable of stopping small abrasive or work piece fragments. The eye protection must be capable of stopping flying debris generated by various operations. The dust mask or respirator must be capable of filtrating particles generated by your operation. Prolonged exposure to high intensity noise may cause hearing loss.
- Only use safety equipment that has been approved by an appropriate standards agency. Unapproved safety equipment may not provide adequate protection. Eye protection must be ANSI-approved and breathing protection must be NIOSH-approved for the specific hazards in the work area.
- Position the cord clear of the spinning accessory. If you lose control, the cord may be cut or snagged and your hand or arm may be pulled into the spinning accessory.

- Do not run the power tool while carrying it at your side. Accidental contact with the spinning accessory could snag your clothing, pulling the accessory into your body.
- Regularly clean the power tool's air vents. The motor's fan will draw the dust inside the housing and excessive accumulation of powdered metal may cause electrical hazards.
- Do not operate the power tool near flammable materials. Sparks could ignite these materials.
- Do not use accessories that require liquid coolants. Using water or other liquid coolants may result in electrocution or shock.
- Do not operate with any guard disabled, damaged, or removed. Moving guards must move freely and close instantly.

 **WARNING:** Some dust created by power sanding, sawing, grinding, drilling, and other construction activities contains chemicals known to the state of California to cause cancer, birth defects or other reproductive harm. Some examples of these chemicals are lead from lead-based paints, crystalline silica from bricks and cement and other masonry products, and arsenic and chromium from chemically-treated lumber. Your risk from these exposures varies, depending on how often you do this type of work. To reduce your exposure to these chemicals: work in a well ventilated area, and work with approved safety equipment, such as those dust masks that are specially designed to filter out microscopic particles. Avoid prolonged contact with dust from power sanding, sawing, grinding, drilling, and other construction activities. Wear protective clothing and wash exposed areas with soap and water. Allowing dust to get into your mouth, eyes, or lay on the skin may promote absorption of harmful chemicals.



WARNING: Use of this tool can generate and/or disperse dust, which may cause serious and permanent respiratory or other injury. Always use NIOSH/OSHA approved respiratory protection appropriate for the dust exposure. Direct particles away from face and body.



WARNING: Do not operate this tool for long periods of time. Vibration caused by the operating action of this tool may cause permanent injury to fingers, hands, and arms. Use gloves to provide extra cushion, take frequent rest periods, and limit daily time of use.



WARNING: The cord of this product contains lead and/or di (2-ethylhexyl) phthalate (DEHP), chemicals known to the State of California to cause cancer, and birth defects or other reproductive harm. Wash hands after handling. (California Health & Safety Code § 25249.5, et seq.)

VIBRATION SAFETY









This tool vibrates during use. Repeated or long-term exposure to vibration may cause temporary or permanent physical injury, particularly to the hands, arms and shoulders. To reduce the risk of vibration-related injury:









- Anyone using vibrating tools regularly or for an extended period should first be examined by a doctor and then have regular medical check-ups to ensure medical problems are not being caused or worsened from use. Pregnant women or people who have impaired blood circulation to the hand, past hand injuries, nervous system disorders, diabetes, or Raynaud's Disease should not use this tool. If you feel any medical or physical symptoms related to vibration (such as tingling, numbness, and white or blue fingers), seek medical advice as soon as possible.
- Do not smoke during use. Nicotine reduces the blood supply to the hands and fingers, increasing the risk of vibration-related injury.
- Use tools with the lowest vibration when there is a choice between different processes.
- Include vibration-free periods each day of work.

- Grip workpiece as lightly as possible (while still keeping safe control of it). Let the tool do the work.
- To reduce vibration, maintain the tool as explained in this manual. If any abnormal vibration occurs, stop use immediately.

SYMBOLS

Some of the following symbols may be used on this product. Please study them and learn their meaning. Proper interpretation of these symbols will allow you to operate the product better and safer.

SYMBOL	NAME	DESIGNATION/EXPLANATION
V	Volts	Alternating voltage
Hz	Hertz	Frequency (cycles per second)
W	Watts	Power
rpm	Per minute	Revolutions per minute
KG	Kilogram	Weight
dB(A)	Decibel(A-rated)	Decibel(A-rated)
mm	Millimetre	Size
M/S ²	Meters per seconds squared	Speed
	Lock	To tighten or secure
	Unlock	To loosen
	Safety Alert	Precautions that involve your safety.
	Read the user's manual	To reduce the risk of injury, user must read and understand user's manual before using this product.
	Eye protection	Wear eye protection when operating this equipment.
	Hearing protection	Use proper hearing protection when operating this equipment.
	Respiratory protection	Use proper respiratory protection when operating this equipment.
	Beware of the fragments of the work piece	Keep bystanders a safe distance away from work area. Fragments of the work piece or of a broken accessory may fly away.

	Protective gloves	Wear protective gloves when operating this equipment.
	Protective, slip-resistant footwear	Wear protective, slip-resistant footwear when operating this equipment.
	Switch the product off	Switch the product off and disconnect it from power supply before assembly, cleaning, adjustments, maintenance, storage and transportation.
	WEEE Symbols	Waste electrical products should not be disposed of with household waste. Please recycle where facilities exist. Check with your Local Authority or local store for recycling advice.
	Wet conditions alert	Do not expose to rain or use in damp locations.
	Electric shock alert	Beware of electric shock hazard.
	Protection class II	This products is of protection class II. That means it is equipped with enhanced or double insulation.
	No touching	Do not touch the blade.
	CE Symbols	The product complies with the applicable European directives and an evaluation method of conformity for these directives was done.

KNOWING YOUR PORTABLE BAND SAW

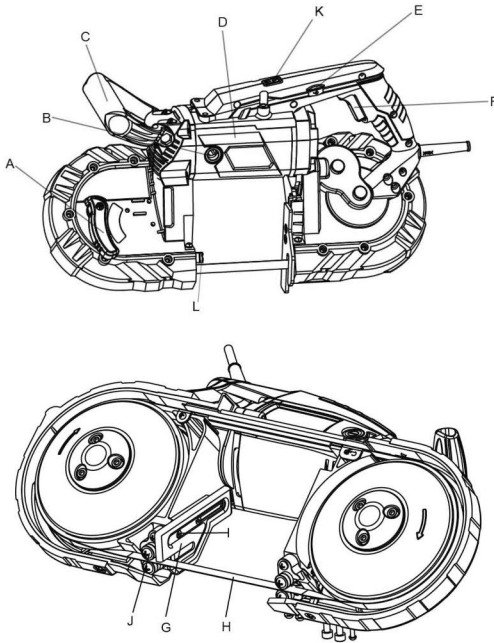

FIG.1

- | | | | |
|---|-----------------------|---|---------------|
| A | Tension handle | G | Guide bar |
| B | External carbon brush | H | Blade |
| C | Auxiliary handle | I | Screw |
| D | Motor housing | J | Guide bearing |
| E | Speed dial | K | LED on/off |
| F | On/Off switch | L | LED light |

Unpacking

Unpack the power tool and all its parts, and compare against the list below. Do not discard the carton or any packaging materials. Please call 1-800-791-9458 or E-mail us at support@amerisuninc.com if any parts are damaged or missing.

Including: Portable band saw/2pcs Blade/S4 Wrench/S6 Wrench/User manual

ASSEMBLY INSTRUCTION



WARNING:

Do not use this product if any parts on the packing list are already assembled to your product when you unpack it. Parts on this list are not assembled to the product by the manufacturer and require customer installation. Use of a product that may have been improperly assembled could result in serious personal injury.



WARNING:

If any parts are damaged or missing do not operate this product until the parts are replaced. Use of this product with damaged or missing parts could result in serious personal injury.



WARNING:

Do not attempt to modify this product or create accessories not recommended for use with this product. Any such alteration or modification is misuse and could result in a hazardous condition leading to possible serious personal injury.



WARNING:

Do not connect to power supply until assembly is complete. Failure to comply could result in accidental starting and possible serious personal injury.

ASSEMBLY

Blade installation and replacement

- Turn the tension handle (A) clockwise to release blade tension as shown in Fig.2.
- Set the blade (H) into both guide bearings (J), making sure the blade is centered on them. Hold the blade on the guides and push in. Make sure the blade evenly fits around the wheels as shown in Fig.3.
- Turn the tension handle (A) until the blade is taut and the handle “Tight”.

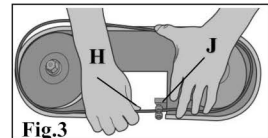
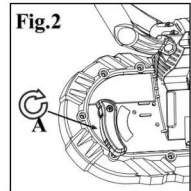

Guide bar assembly

- Assemble the guide bar (G) to the bandsaw before operation as shown in Fig.4.
- Release the screws (I) on the Frame.
- Move the guide bar (G) around the blade, then lock the screws.
- Plug in the tool and put on your ear/eye protection, and turn on the tool. Inspect the blade and make sure it runs steady and evenly around the wheels, and that the teeth are pointed in the correct direction.

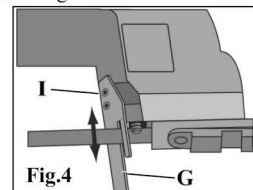

**WARNING:**

Do not apply force to the tool by pressing too hard with your hands or leaning into it. The weight of the tool itself creates enough force to make a clean cut. Forcing or leaning on the tool may twist or break the blade, damaging the saw and possibly causing injury. As you reach the end of your work piece, finish off the cut by slightly raising the unit slowly, bringing the blade up.

OPERATING INSTRUCTION

WARNING: DO NOT expose this tool to rain or use in damp locations.



WARNING: Connect the tool via a fault current (FI) circuit breaker with a triggering current of 30 mA maximum if you use it OUTDOOR.

Before use

- Before using the tool for the first time, it is recommended to receive practical information.
- Always check that the supply voltage is the same as the voltage indicated on the nameplate of the tool .
- Use suitable detectors to find hidden utility lines or call the local utility company for assistance(contact with electric lines can lead to fire or electrical shock; damaging a gas line can result in an explosion; penetrating a water pipe will cause property damage or an electrical shock).
- Do not work materials containing asbestos (asbestos is considered carcinogenic) .
- Dust from material such as paint containing lead, some wood species, minerals and metal may be harmful (contact with or inhalation of the dust may cause allergic reactions and/or respiratory diseases to the operator or bystanders); wear a dust mask and work with a dust extraction device when connectable .
- Certain kinds of dust are classified as carcinogenic (such as oak and beech dust) especially in conjunction with additives for wood conditioning; wear a dust mask and work with a dust extraction device when connectable.
- Follow the dust-related national requirements for the materials you want to work with.
- Do not clamp the tool in a vice.
- Use completely unrolled and safe extension cords with a capacity of 16 Amps (U.K. 13 Amps) .

Workpiece and work area set up

- Designate a work area that is clean and well-lit. The work area must not allow access by children or pets to prevent distraction and injury.
- Route the power cord along a safe route to reach the work area without creating a tripping hazard or exposing the cord to possible damage. The power cord must reach the work area with enough extra length to allow free movement while working.
- There must not be objects, such as utility lines, nearby that will present a hazard while working.

After use

After switching off the tool, never stop the rotation of the accessory by a lateral force applied against it.

USE

Switching the machine on and off (Fig.5)

- Turn on/off the portable band saw by switch (F) electronic speed control.
- Adjust the speed by turning the speed dial (E), user can choose different speed for different cutting materials.

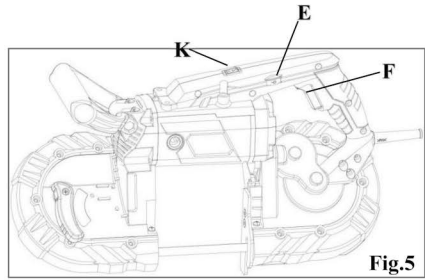

Fig.5

Switching the LED light on and off

- Turn on/off the LED light by switch (K).

Cutting Operations (Fig.6)

- Make sure that the switch is in the off-position, then plug in the tool.
- Secure your work piece to a workbench or other solid surface.
- Make sure the cord is out of the way.
- Set the guide bar against the workpiece, keeping blade at a 90° angle compared to the workpiece.
- Turn on the band saw and allow it to come up to full speed before starting the cut.
- Adjust speed by turning the speed dial.
- Tilt the unit so that the blade is vertical as shown in. To start a cut, use minimal force to start a groove. Once groove is started, allow the rest of the blade to cut into workpiece. Doing this will prevent blade from moving from side-to-side during cutting.
- Straight cutting can be accomplished by keeping the band saw blade aligned with the side surface of the motor housing. Any twisting or cocking of the blade will cause the cut to go offline and decrease the life of the blade.

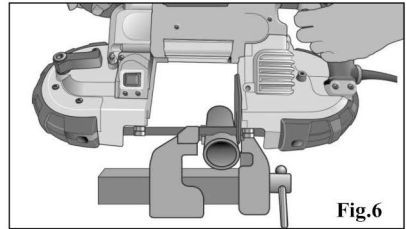

Fig.6



WARNING:Never attempt to use this tool by resting it upside down on a work surface and bringing the material to the tool. Always securely clamp the workpiece and bring the tool to the work piece, securely holding the tool with two hands.



WARNING:During cutting, if the band saw becomes locked or jammed in the work piece material, release the switch immediately to avoid damage to the band saw blade and motor.



WARNING:When saw reaches desired rotation speed, slowly and gently tilt the main body of the tool to bring the band saw blade into contact with the workpiece. Do not apply additional pressure in excess of the weight of the main body of the tool. Carefully avoid bringing the band saw blade suddenly and heavily into contact with the upper surface of the workpiece. This will cause serious damage to the band saw blade. To obtain maximum service life of the band saw blade, ensure there is no sudden impact at the beginning of the cutting operation.

MAINTENANCE



WARNING: Always turn the switch OFF, unplug the power cord from the outlet before maintaining portable band saw.



WARNING: When servicing, use only identical replacement parts. Use of any other parts could create a hazard or cause product damage.

- Store the tool in its protective case in a dry and locked up place, out of reach of children.
- Always keep tool and cord clean (especially ventilation slots).
- Periodically, wear ANSI-approved safety goggles and NIOSH-approved breathing protection and blow dust out of the motor vents using dry compressed air.
- Store in a clean and dry location.
- Protect the tool from impact, shock and grease.
- Do not attempt to clean ventilation slots by inserting pointed objects through openings.
- Disconnect the plug before cleaning.
- Do not dispose of electric tools, accessories and packaging together with household waste material (only for EU countries) .

TROUBLE SHOOTING



WARNING: Read instruction manual first! Remove plug from the power source before trouble shooting.

Problem	Possible Cause	Possible Solution
Motor is not working	1) Wires in the main plug or in the socket are loose. 2) The switch is faulty.	1) Wires in the main plug or in the socket are loose. 2) The switch is faulty.
Unusual noises occur during operation. Motor is not working properly.	1) Switch contact has failed. 2) Components have jammed. 3) Too high of load has been applied.	1) Have the switch replaced by an authorized technician. 2) Have the tool checked and repaired. 3) Use less pressure during operations.
Motor gets hot.	1) Foreign substances have gotten inside the motor. 2) Too high of load has been applied.	1) Have the foreign substances removed. 2) Use less pressure during operations.



WARNING: Follow all safety precautions whenever diagnosing or servicing the tool. Disconnect power supply before service.

EXPLODED VIEW

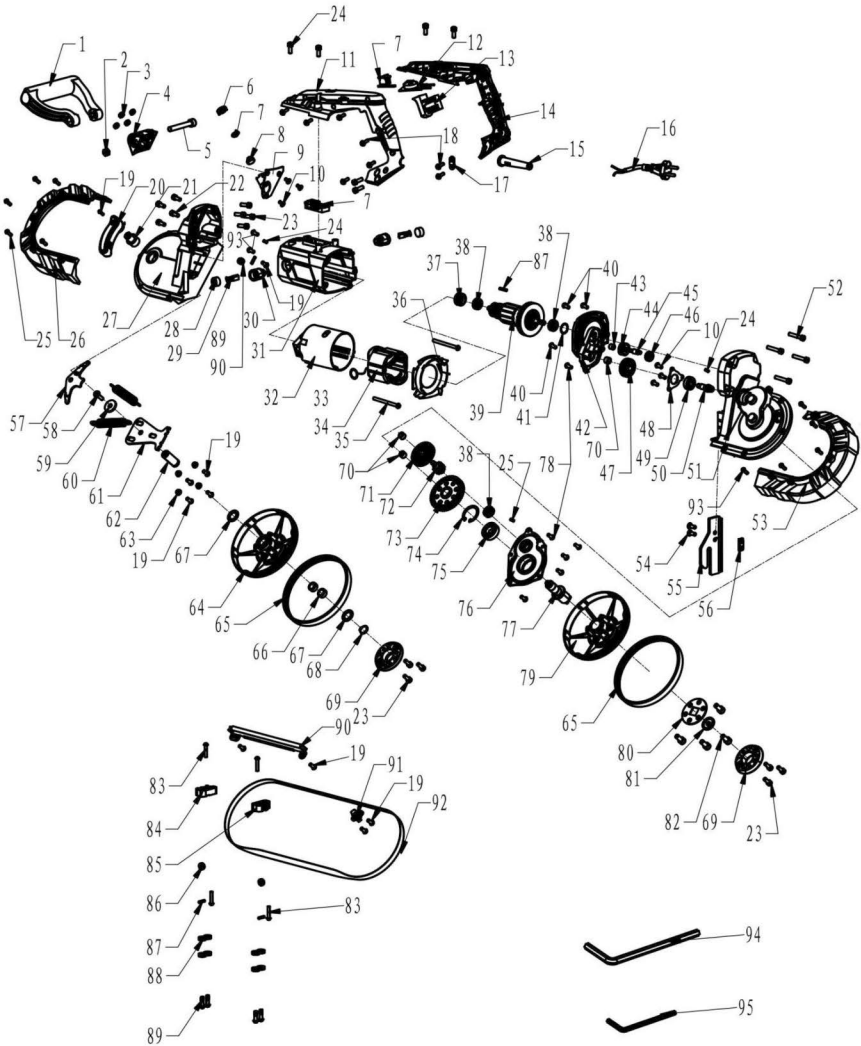

PARTS LIST

Item	Stock#	Description	Qty.
1	PS3050-001	Auxiliary Handle	1
2	PS3050-002	Screw M8	1
3	PS3050-003	Hex Screw M6	4
4	PS3050-004	Auxiliary Handle Holder	1
5	PS3050-005	Screw M8×70	1
6	PS3050-006	LED cover	1
7	PS3050-007	LED light	1
8	PS3050-008	Reflector	1
9	PS3050-009	LED Holder	1
10	PS3050-010	Screw M4×8	6
11	PS3050-011	Left handle	1
12	PS3050-012	Speed controller	1
13	PS3050-013	Switch	1
14	PS3050-014	Right handle	1
15	PS3050-015	sleeve	1
16	PS3050-016	cable	1
17	PS3050-017	cable plate	1
18	PS3050-018	screw	8
19	PS3050-019	screw	10
20	PS3050-020	wrench	1
21	PS3050-021	Tension Spindle	1
22	PS3050-022	screw M6×20	4
23	PS3050-023	screw M6×14	16
24	PS3050-024	Round Pin	3
25	PS3050-025	screw M5×12	10
26	PS3050-026	Gear Box Bump Guard	1
27	PS3050-027	Support Holder	1
28	PS3050-028	Brush cover	2
29	PS3050-029	Carbon brush	2
30	PS3050-030	Brush holder	2

Item	Stock#	Description	Qty.
31	PS3050-031	Housing	1
32	PS3050-032	Stator sleeve	1
33	PS3050-033	Tension spring	2
34	PS3050-034	Stator	1
35	PS3050-035	screw 4.8×55	2
36	PS3050-036	Baffle Plate	1
37	PS3050-037	Bearing Sleeve	1
38	PS3050-038	Bearing 608Z SYBS	3
39	PS3050-039	Rotor	1
40	PS3050-040	Screw M5×10	3
41	PS3050-041	O ring	1
42	PS3050-042	Middle cover	1
43	PS3050-043	Needle bearingHK0608	1
44	PS3050-044	Gear	1
45	PS3050-045	Gear spindle	1
46	PS3050-046	Bearing 626	1
47	PS3050-047	I big gear	1
48	PS3050-048	Bearing Cover	1
49	PS3050-049	Bearing 6000z2RS	1
50	PS3050-050	II gear shaft	1
51	PS3050-051	Gear box	1
52	PS3050-052	screw M6×40	4
53	PS3050-053	Gear case sleeve	1
54	PS3050-054	screw M6*16	2
55	PS3050-055	Block	1
56	PS3050-056	Slide Block	1
57	PS3050-057	Adjust holder	1
58	PS3050-058	screw M6×16	1
59	PS3050-059	Select wheel	1
60	PS3050-060	Spring	2

Item	Stock#	Description	Qty.
61	PS3050-061	Movable support	1
62	PS3050-062	Drive Shaft	1
63	PS3050-063	Locating Sleeve	4
64	PS3050-064	Driven plate	1
65	PS3050-065	Non-slip Band	2
66	PS3050-066	Steel sleeve	2
67	PS3050-067	Dust-Proof Mat	2
68	PS3050-068	Circlip	1
69	PS3050-069	Driven plate cover	2
70	PS3050-070	Needle bearing HK0808	3
71	PS3050-071	II big gear	1
72	PS3050-072	III gear shaft	1
73	PS3050-073	III big gear	1
74	PS3050-074	Circlip	1
75	PS3050-075	Bearing 6003z22RS	1
76	PS3050-076	Gear box cover	1
77	PS3050-077	Output shaft	1
78	PS3050-078	screw M5×14	6

Item	Stock#	Description	Qty.
79	PS3050-079	Driven plate	1
80	PS3050-080	Coupling piece	1
81	PS3050-081	Output shaft plate	1
82	PS3050-082	Screw M8×14	4
83	PS3050-083	Screw M5×25	4
84	PS3050-084	Bearing block II	1
85	PS3050-085	Bearing block I	1
86	PS3050-086	Bearing 624	3
87	PS3050-087	Round Pin 4×16	4
88	PS3050-088	Bearing 696	8
89	PS3050-089	Screw	4
90	PS3050-090	Blade Holder	1
91	PS3050-091	Brush	1
92	PS3050-092	Blade	1
93	PS3050-093	Screw M4x8	2
94	PS3050-094	Wrench S6	1
95	PS3050-095	Wrench S4	1

TWO (2) YEARS LIMITED WARRANTY

PowerSmart® is committed to building tools that are dependable for years. Our warranties are consistent with our commitment and dedication to quality.

TWO (2) YEARS LIMITED WARRANTY OF POWERSMART PRODUCTS FOR HOME USE.

PowerSmart ("Seller") warrants to the original purchaser only, that all PowerSmart consumer power tools will be free from defects in material or workmanship for a period of two (2) years from date of purchase. Ninety (90) days for all PowerSmart Products, if the tool is used for professional or commercial use.

SELLER'S SOLE OBLIGATION AND YOUR EXCLUSIVE REMEDY under this Two (2) Years Limited Warranty and, to the extent permitted by law, any warranty or condition implied by law, shall be the repair or replacement of parts, without charge, which are defective in material or workmanship and which have not been misused, carelessly handled, or misrepaired by persons other than Seller or Authorized Service Center. To make a claim under this Limited Warranty, you must return the entire power tool product; transportation prepaid, to PowerSmart Include a legible copy of the original receipt, which lists the date of purchase (month and year) and the name of the company purchased from.

THIS LIMITED WARRANTY DOES NOT APPLY TO ANY ACCESSORY ITEMS INCLUDED WITH THE TOOL SUCH AS CIRCULAR SAW BLADES OTHER RELATED ITEMS OR TO ANY REPLACEMENT PARTS LISTED UNDER MAINTENANCE.

ANY IMPLIED WARRANTIES SHALL BE LIMITED IN DURATION TO TWO (2) YEARS FROM DATE OF PURCHASE. SOME STATES IN THE U.S. AND SOME CANADIAN PROVINCES DO NOT ALLOW LIMITATIONS ON HOW LONG AN IMPLIED WARRANTY LASTS, SO THE ABOVE LIMITATION MAY NOT APPLY TO YOU.

IN NO EVENT SHALL SELLER BE LIABLE FOR ANY INCIDENTAL OR CONSEQUENTIAL DAMAGES (INCLUDING BUT NOT LIMITED TO LIABILITY FOR LOSS OF PROFITS) ARISING FROM THE SALE OR USE OF THIS PRODUCT. SOME STATES IN THE U.S. AND SOME CANADIAN PROVINCES DO NOT ALLOW THE EXCLUSION OR LIMITATION OF INCIDENTAL OR CONSEQUENTIAL DAMAGES, SO THE ABOVE LIMITATION OR EXCLUSION MAY NOT APPLY TO YOU.

THIS LIMITED WARRANTY GIVES YOU SPECIFIC LEGAL RIGHTS, AND YOU MAY ALSO HAVE OTHER RIGHTS WHICH VARY FROM STATE TO STATE IN THE U.S., PROVINCE TO PROVINCE IN CANADA AND FROM COUNTRY TO COUNTRY.

For questions / comments, technical assistance or repair parts –
Please call toll free at: 1-800-791-9458 (M-F 9am – 5pm EST)
Email: support@amerisuninc.com

SAVE YOUR RECEIPTS. THIS WARRANTY IS VOID WITHOUT THEM.