

ASSEMBLY INSTRUCTIONS

PLEASE RETAIN THESE INSTRUCTIONS FOR FUTURE USE

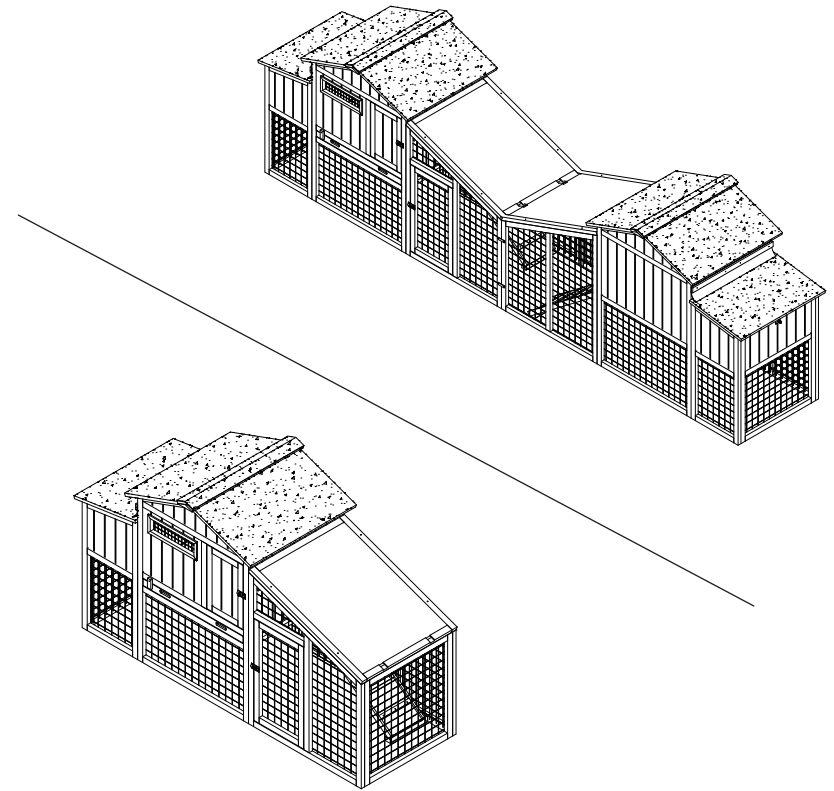

TIME ASSEMBLE : 30-60 minutes



NUMBER OF PERSON: 2

Greeting!
So here I am



your new pet house

- ▶ Thanks for letting me be a home for your furry friend(s).
- ▶ They'll be cozy and protected from the weather when they're with me.
- ▶ Just remember to take care of me too, so I can last a long time.
- ▶ When you first get me, you might smell a funny smell. Don't worry, it's not dangerous.
- ▶ Just let me air out for a few days and the smell will go away.
- ▶ Be careful when you're putting me together because some of my parts can be sharp or heavy.
- ▶ Make sure to start by loosely putting in screws, and then tighten them all before using me.
- ▶ If you notice anything broken or missing, stop using me until it's fixed, and please follow the instructions from the maker so your warranty stays good.
- ▶ You can use me both inside and outside, but if you put me outside, make sure to give me an extra cover to keep me from getting moldy.
- ▶ I like to be on a level surface so my doors work smoothly.
- ▶ Keep me away from fire and dangerous chemicals.
- ▶ Clean me with a damp, soapy sponge without corrosive agents.
- ▶ Dry me with a soft, clean, dry cloth.
- ▶ Do not use a high pressure cleaner on me.
- ▶ Do not use bleach, acids, solvents, or abrasive cleaners on me.
- ▶ Check that all my bolts, screws, and knobs are tight every 90 days.



HELP CENTER

- ▶ Your full satisfaction is our **FIRST** priority
- ▶ We hope you enjoy it and have a good shopping experience.
- ▶ We are committed to resolve any situation when it does not meet your expectations.
- ▶ Please feel free to contact us through order detail page, we will get back to you and solve them within 24 hours.

- K  2PCS
- L M3.0*18  4PCS

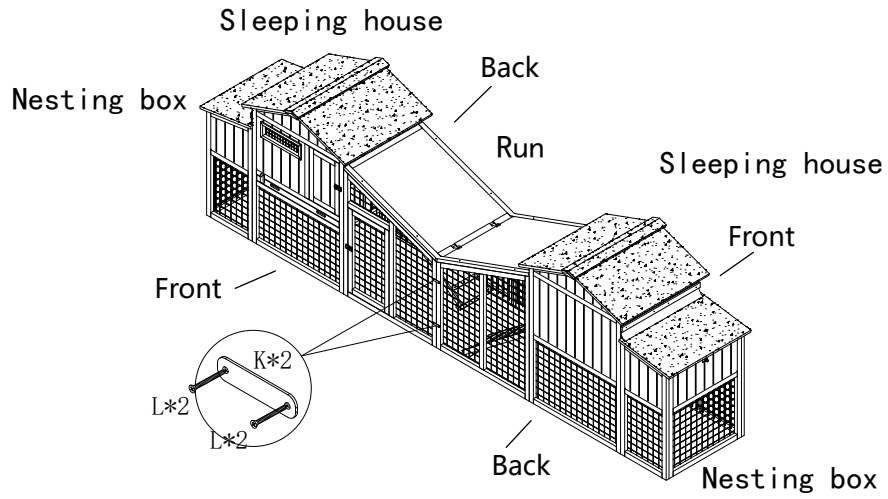

Connect the two set together with (K)*2 Metal connectors, then fix the screws.

STEP 19

- K  2PCS
- L M3.0*18  4PCS

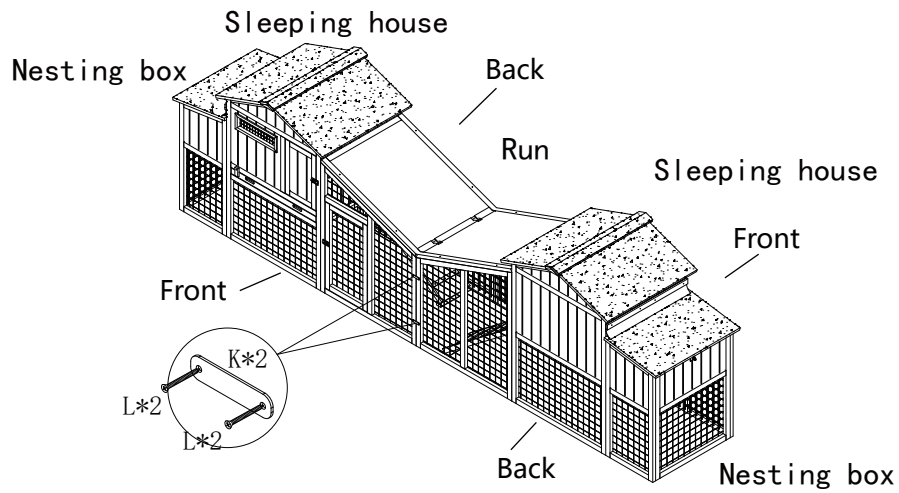



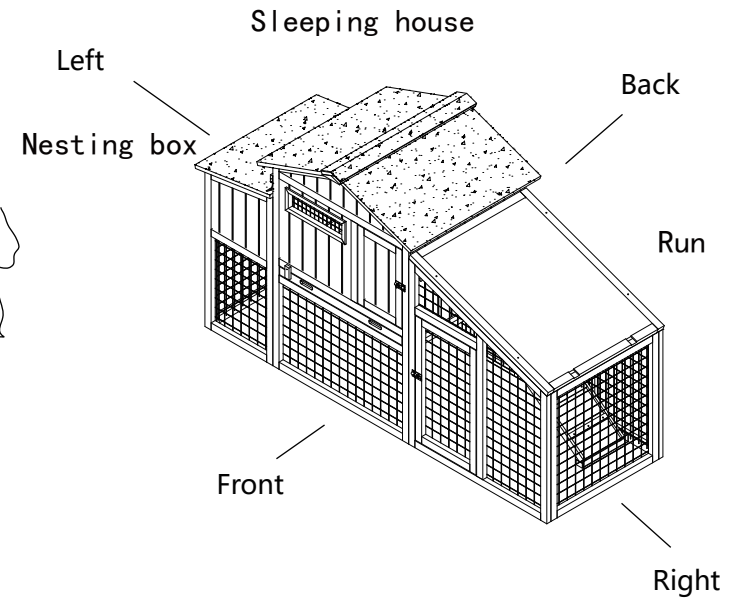
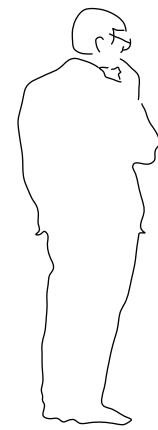

Connect the two set together with (K)*2 Metal connectors, then fix the screws.

STEP 20

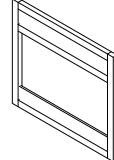
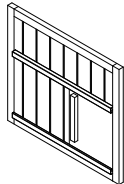
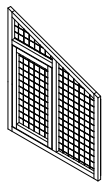
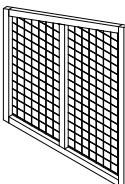
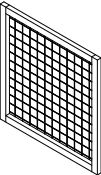
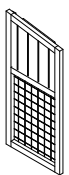
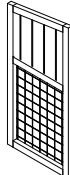

ASSEMBLY INSTRUCTION

Tool Required:  Electric Drill  Phillips Screwdriver

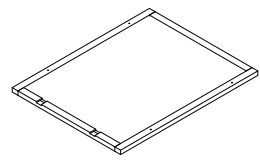
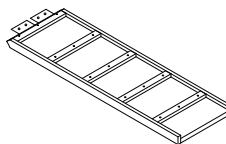
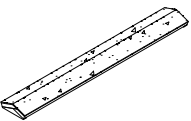
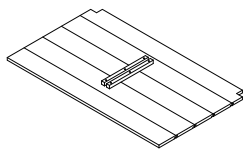
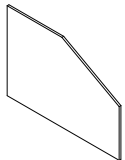
		
① Front panel of sleeping house	② Back panel of sleeping house	③ Left panel of sleeping house
		
④ Right panel of sleeping house	⑤ Front panel of run	⑥ Back panel of run
		
⑦ Side panel of run	⑧ Back panel of nesting box	⑨ Front panel of nesting box
		
⑩ Left panel of nesting box	⑪ Roof of run	⑫ Ramp
		
⑬ Ridge of sleeping house	⑭ Bottom panel of nesting box	⑮ Divider panel of nesting box

ASSEMBLY INSTRUCTIONS FOR TWO SETS CONNECTION

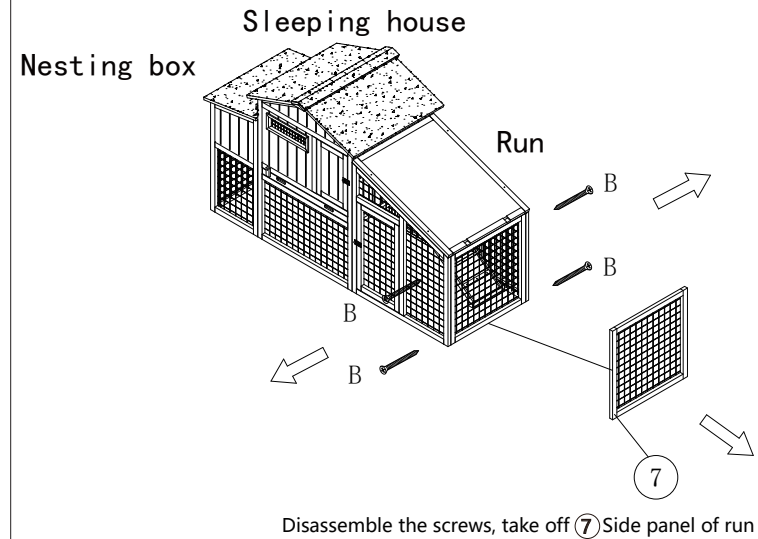

STEP 17

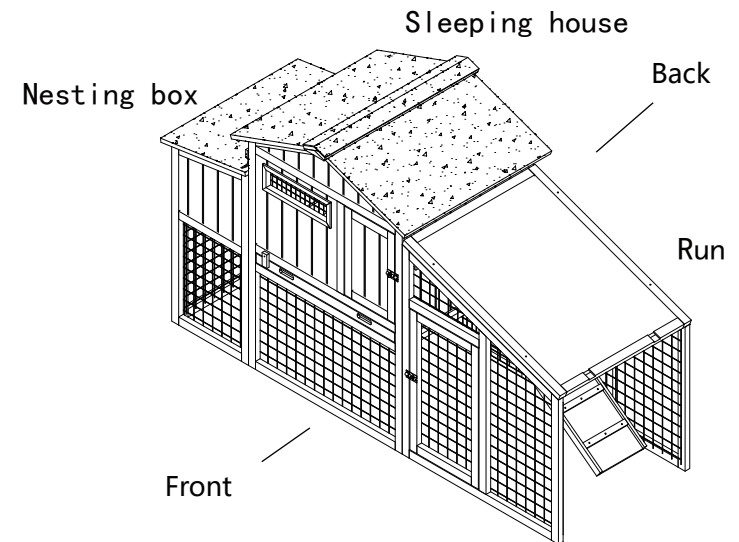

Repeated to assemble the second set except to assemble ⑦ Side panel of run.

STEP 18

C M3.5*35 8PCS

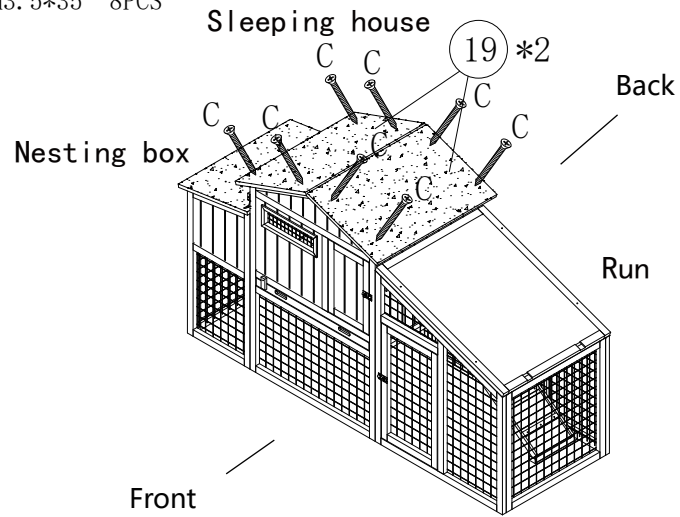

Fix 19*2 Roof of sleeping house with screws.

STEP 15

D M3.0*25 4PCS

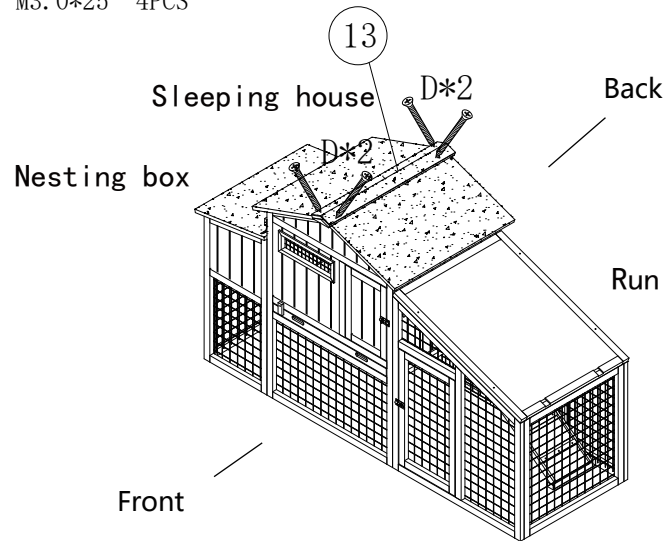

Fix 13 Ridge of sleeping house with screws.

STEP 16

ASSEMBLY INSTRUCTION

Tool Required: Electric Drill Phillips Screwdriver

16 Roof of nesting box	17 Supporter of ramp	18 Tray
19 x2 Roof of sleeping house	20 x2 Perches	21 Curtain of nesting box

Parts Description

	Parts Description	
	A M3.5*50	8PCS+1
	B M3.5*45	18PCS+1
	C M3.5*35	8PCS+1
	D M3.0*25	5PCS+1
	E M3.0*23	3PCS+1
	F M6*50	4PCS
	G M3.0*16	18PCS+1
	H	2PCS
	I M3.5*40	6PCS+1
	J	1PC
	K	4PCS
	L M3.0*18	8PCS+1

H  1PC
G M3.0*16 4PCS

I M3.5*40 2PCS

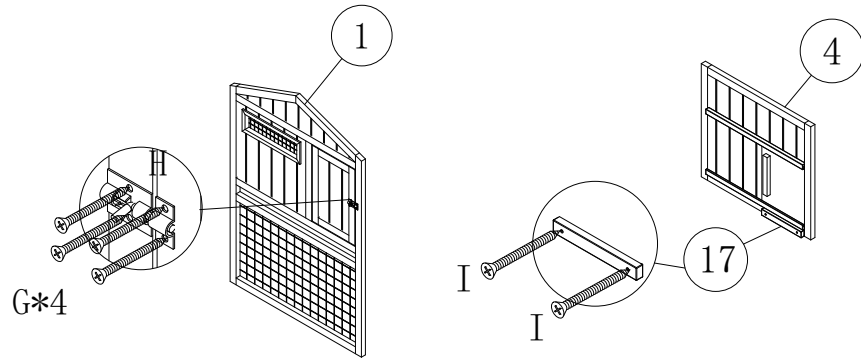

Fix (H) Bolt on ① Front panel of sleeping house with screws,
Fix ⑰ Supporter of ramp on ④ Right panel of sleeping house with screws

STEP 1

B M3.5*45 8PCS

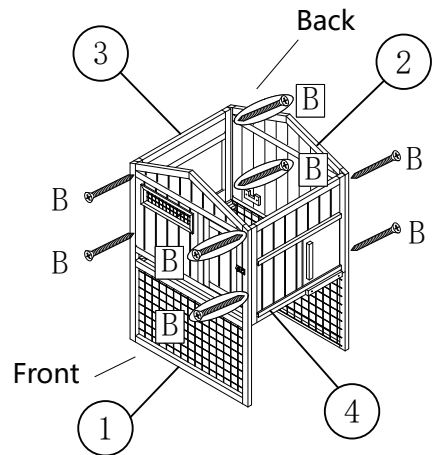

Attach ① Front panel of sleeping house,
② Back panel of sleeping house,
③ Left panel of sleeping house,
④ Right panel of sleeping house together
with screws.

STEP 2

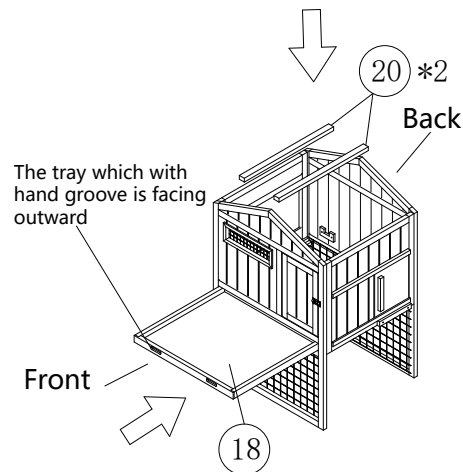

Insert ⑱ Tray .
Insert ⑳ *2 Perches .

STEP 3

B M3.5*45 4PCS

Sleeping house

Back

Nesting box

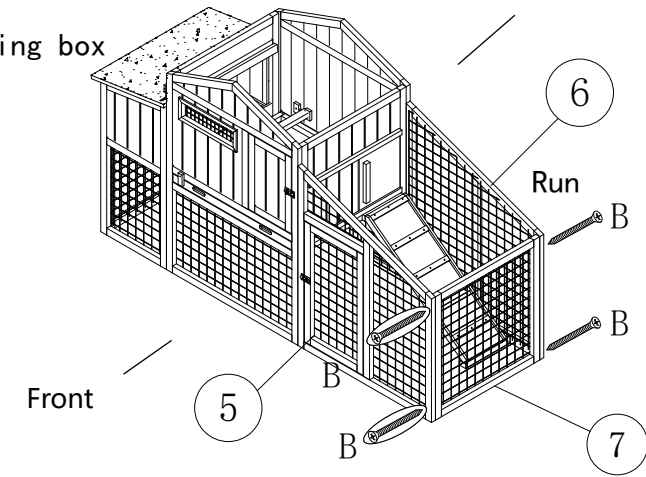

Fix ⑦ Side panel of run on ⑤ Front panel of run and ⑥ Back panel of run with screws.

STEP 13

I M3.5*40 4PCS

Sleeping house

Back

Nesting box

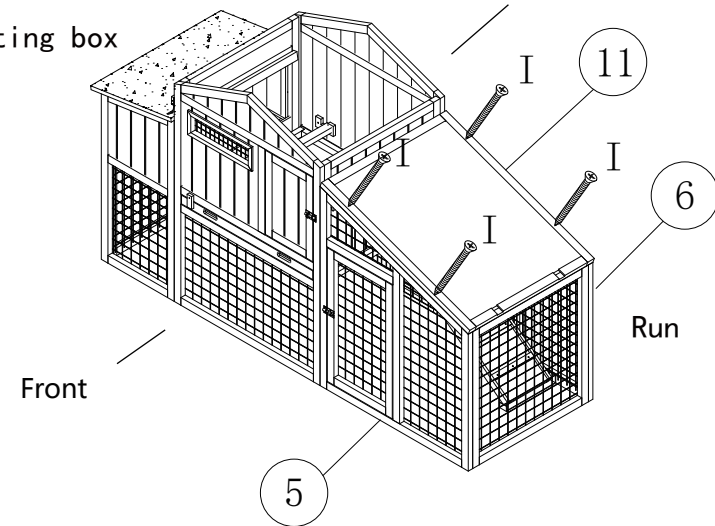

Fix ⑪ Roof of run on ⑤ Front panel of run and ⑥ Back panel of run with screws.

STEP 14

G M3.0*16 4PCS

H  1PC

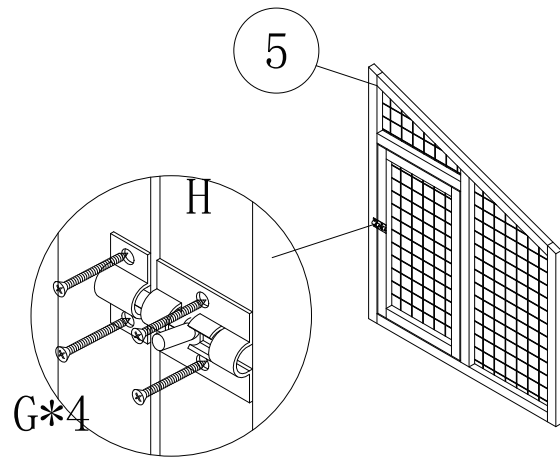

Fix (H) Bolt on ⑤ Front panel of run with screws.

STEP 11

A M3.5*50 6PCS

Sleeping house

Nesting box

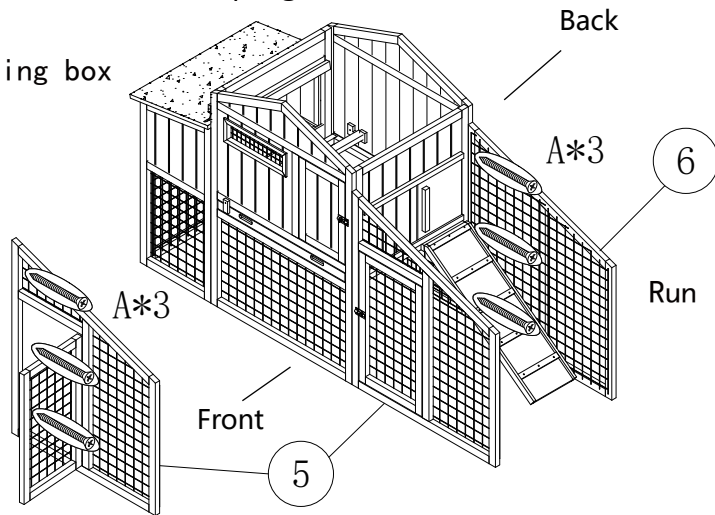

Fix ⑤ Front panel of run and ⑥ Back panel of run on sleeping house with screws.

STEP 12

D M3.0*25 1PCS

J  1PC

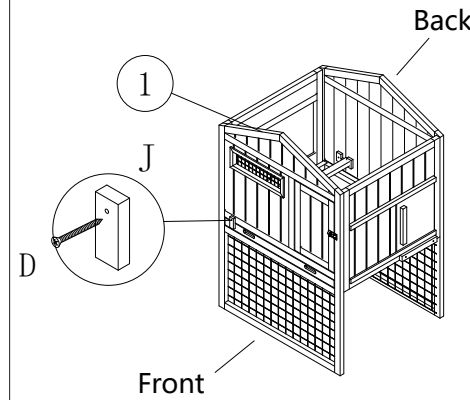

Fix (J) Wooden knob on ① Front panel of sleeping house with screw.

STEP 4

A M3.5*50 2PCS

F M6*50 4PCS

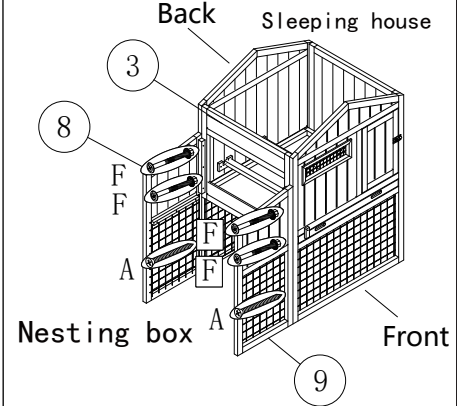

Fix ⑧ Back panel of nesting box, ⑨ Front panel of nesting box on ③ Left panel of sleeping house with screws.

STEP 5

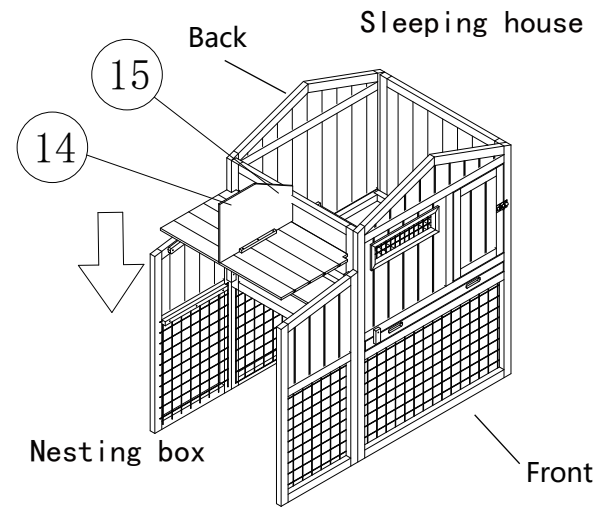

Put in ⑭ Bottom panel of nesting box, Insert ⑮ Divider panel of nesting box.

STEP 6

B M3.5*45 6PCS

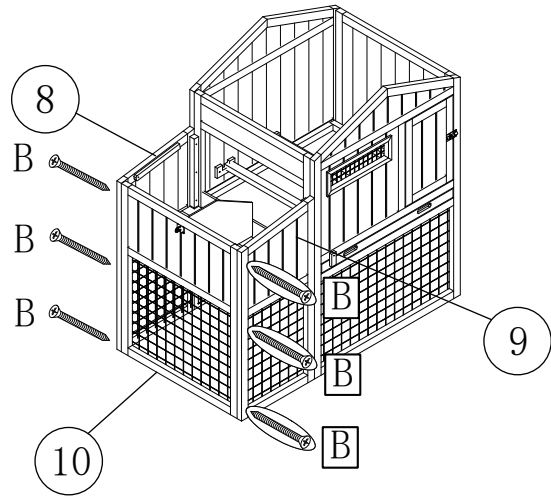

Fix 10 Left panel of nesting box on
 8 Back panel of nesting box and
 9 Front panel of nesting box with screws.

STEP 7

G M3.0*16 6PCS

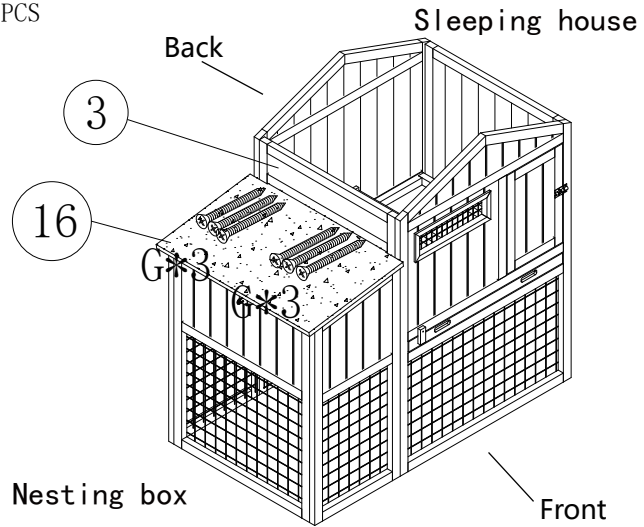

Fix 16 Roof of nesting box on 3 Left panel of sleeping house with screws.

STEP 8

E M3.0*23 3PCS

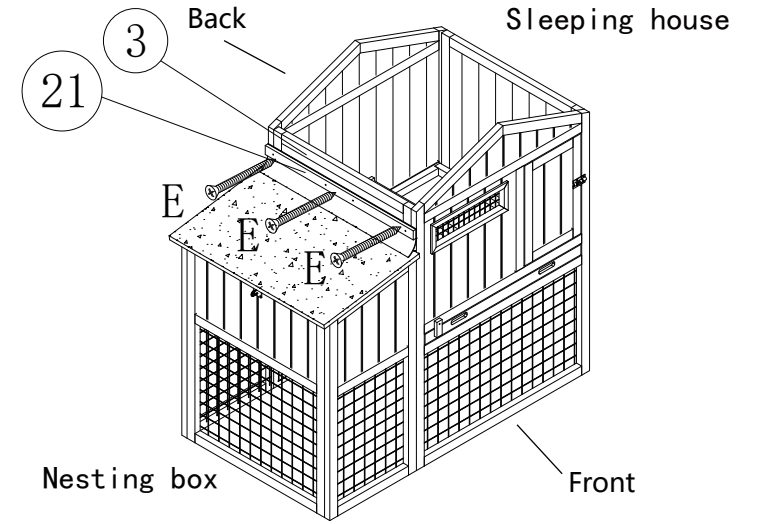

Fix 21 Curtain of nesting box on 3 Left panel of sleeping house with screws.

STEP 9

G M3.0*16 4PCS

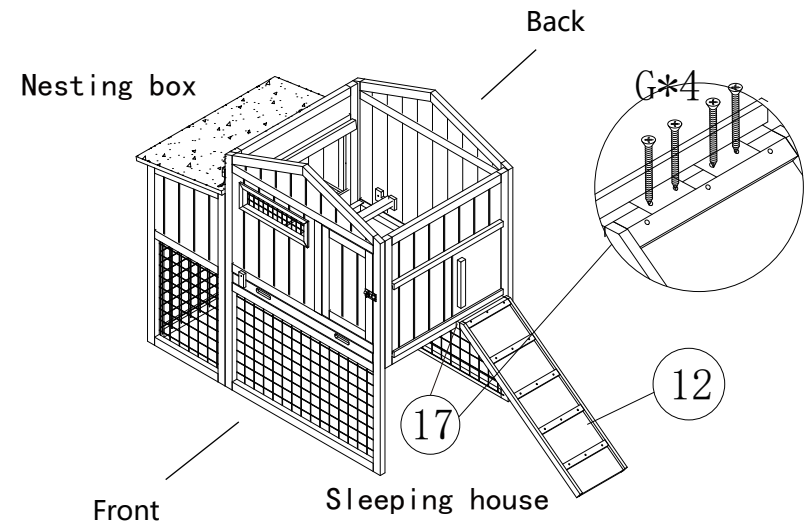

Fix 12 Ramp on 17 Supporter of ramp with screws.

STEP 10