

PHANTOM 4 PRO

Quick Start Guide

V1.0

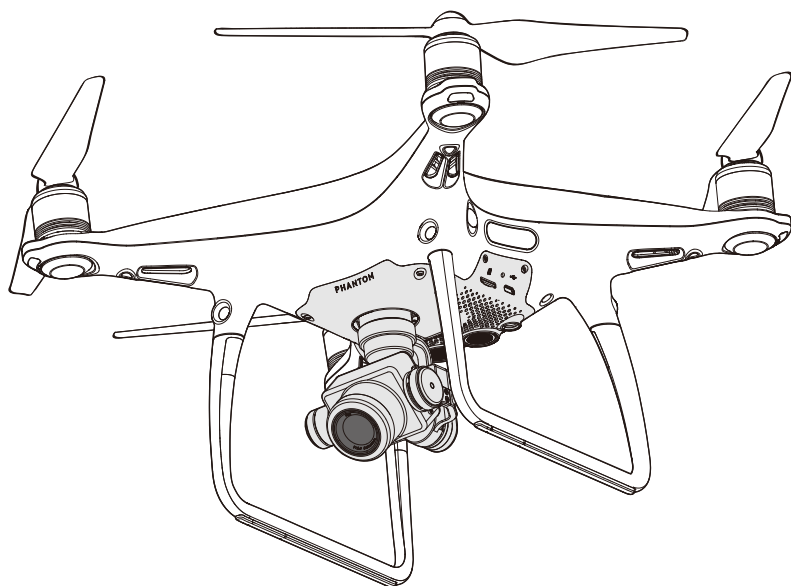

Phantom 4 Pro

The DJI PHANTOM™ 4 Pro is a smart prosumer flying camera capable of shooting 4K video at 60fps and at up to 100mbps, and capturing 20 megapixel stills. 4 directions of obstacle avoidance allow it to intelligently avoid obstacles during flight. Using upgraded TapFly™ and ActiveTrack™ through the DJI GO™ 4 app, you can fly anywhere visible on your screen or track a moving subject smoothly and easily with a simple tap. The brand new camera uses a 1-inch CMOS sensor offering unprecedented clarity, lower noise, and better quality images.

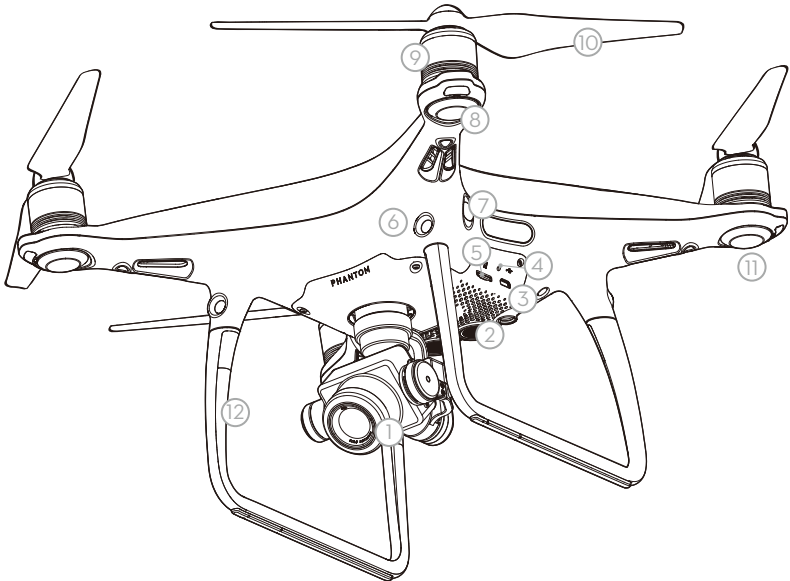

- | | |
|--|--------------------------------|
| 1. Gimbal and Camera | 9. Motors |
| 2. Downward Vision System* | 10. Propellers |
| 3. Micro USB Port | 11. Aircraft Status Indicators |
| 4. Camera/Linking Status Indicator and Link Button | 12. Antennas |
| 5. Camera Micro SD Card Slot | 13. Rear Vision System |
| 6. Forward Vision System | 14. Intelligent Flight Battery |
| 7. Infrared Sensing System* | 15. Power Button |
| 8. Front LEDs | 16. Battery Level Indicators |

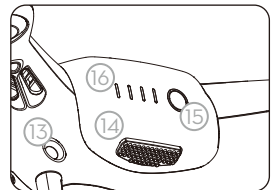

* The Vision and Infrared Sensing Systems are affected by surrounding conditions. Read the Disclaimer and Safety Guidelines and watch the tutorials in the DJI GO 4 app or on the official DJI website to learn more.

Remote Controller

The powerful remote controller of the Phantom 4 Pro has a transmission range extending up to 4.3 mi (7 km)*. It features physical buttons and dials to control exposure, camera tilt, photo capture and video recording.

Built into the remote controller is DJI LIGHTBRIDGE™, which when paired with a compatible mobile device gives you a live HD view from the Phantom's camera. Dual frequency support makes the HD video downlink more stable. An internal battery ensures a long battery life and ease of use.

1. Power Button
2. Return-to-Home (RTH) Button
3. Control Sticks
4. Status LED
5. Battery Level LEDs
6. Power Port
7. Mobile Device Holder
8. Small Device Positioning Tabs (for mobile phones)
9. Antennas
10. Handle Bar

11. Gimbal Dial
12. Camera Settings Dial
13. Record Button
14. Flight Mode Switch
15. Shutter Button
16. Intelligent Flight Pause Button (customizable)
17. C1 and C2 Buttons
18. USB Port
19. Micro USB Port

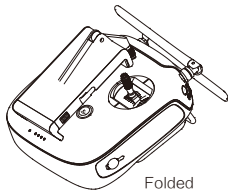
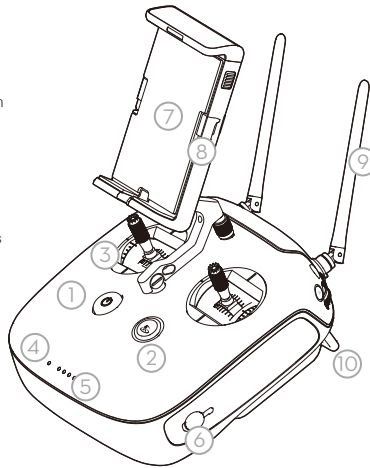

Folded

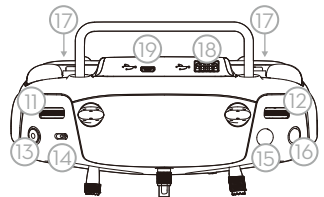

The default flight control is known as Mode 2. The left stick controls the aircraft's altitude and heading, while the right stick controls its forward, backward, left and right movements. The gimbal dial controls the camera's tilt.

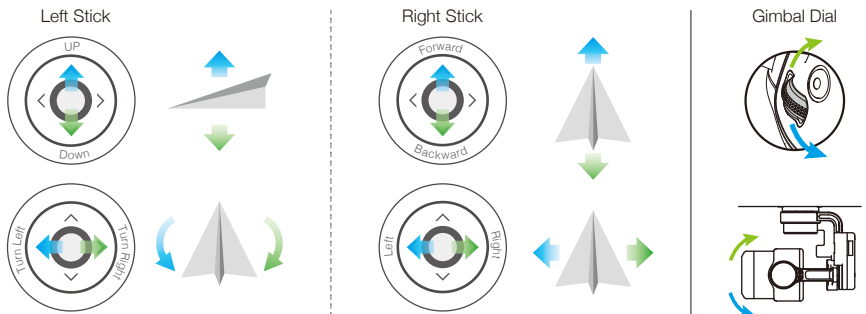

* The remote controller is able to reach its maximum transmission distance (FCC) in a wide open area with no Electro-Magnetic Interference, and at an altitude of about 400 feet (120 meters).

Using Phantom 4 Pro

1. Download the DJI GO 4 App

Search for 'DJI GO 4' on the App Store or Google Play, and install the app on your mobile device.



DJI GO 4 App

2. Watch the Tutorial Videos

Watch the tutorial videos at www.dji.com or in the DJI GO 4 app.



Tutorial Videos

 • DJI GO 4 supports iOS 9.0 (or later) or Android 4.4 (or later).

3. Check the Battery Levels

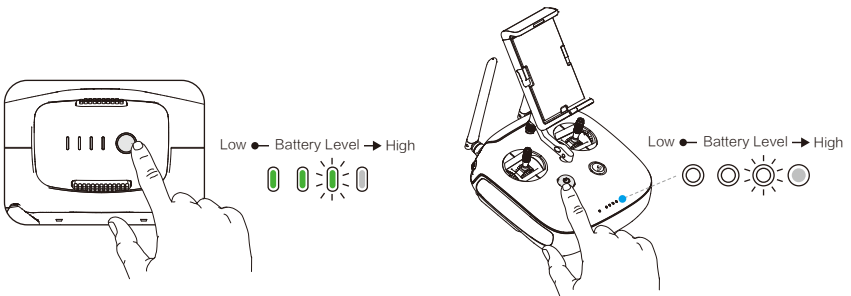

Press once to check the battery level. Press once, then again and hold to turn on/off.

4. Charge the Batteries

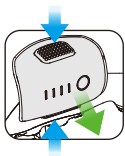

Remove the battery.

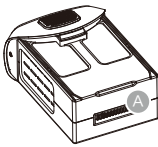

Charge Time:
~1 hr 20 min

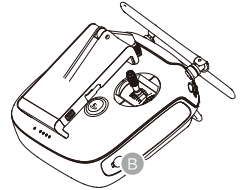
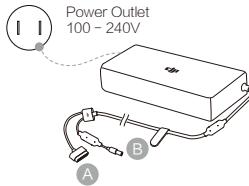

Charge Time:
~3 hr 40 min

 • When charging is complete, the battery level indicators will automatically turn off.

5. Prepare the Remote Controller

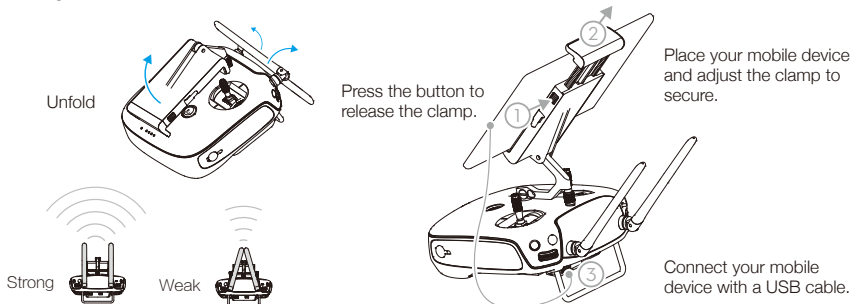

6. Prepare for Takeoff

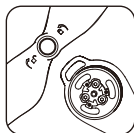
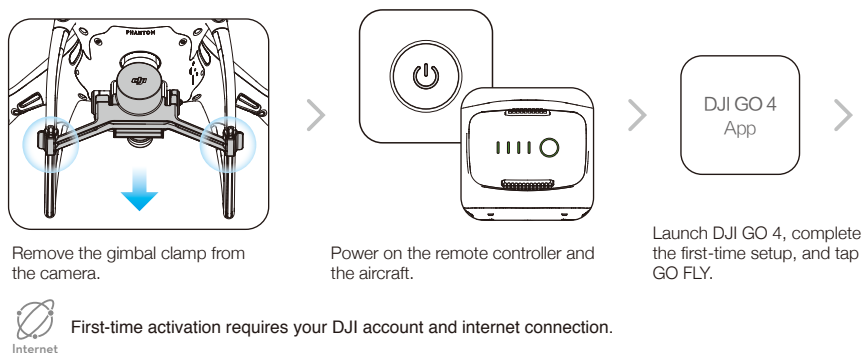

Black propeller rings go on motors with black dots.



Press the propeller down onto the mounting plate and rotate in the lock direction (🔒) until secure.

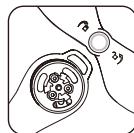

Silver propeller rings go on motors without black dots.

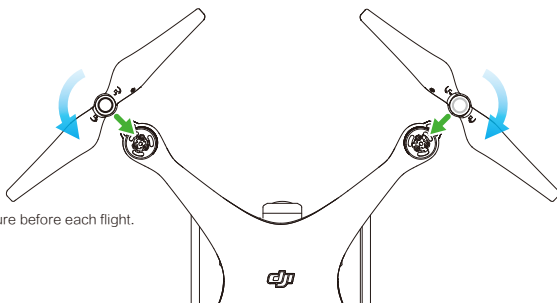

! Check that the propellers are secure before each flight.

7. Flight

Ready to Go (GPS)

Before taking off, make sure the Aircraft Status Bar in the DJI GO 4 app indicates 'Ready to Go (GPS)' or 'Ready to Go (Vision)' if flying indoors.

In the DJI GO 4 App:



Auto Takeoff

The aircraft will take off and hover at an altitude of 4 feet (1.2 meters).



Auto Landing

The aircraft will land vertically and stop its motors.



Return-to-Home (RTH)

Bring the aircraft back to the Home Point. Tap again to stop the procedure.



Normal

You are in control of the Phantom, with satellite and Return-to-Home support.



TapFly

Tap on your screen to fly your Phantom in that direction, avoiding obstacles as it flies.



ActiveTrack

Mark an object on your screen to track it as it moves.



- Watch the tutorial in the DJI GO 4 app or on the official DJI website to learn more.
- Always set an appropriate RTH altitude before takeoff. When the aircraft is returning to the Home Point, you should guide it with the control sticks. Refer to the Disclaimer and Safety Guidelines for more details.

Manual Takeoff



Combination Stick Command to start/stop the motors

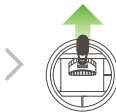

Left stick up (slowly) to take off

Manual Landing



Left stick down (slowly) until you touch the ground
Hold a few seconds to stop the motors



- Rotating propellers can be dangerous. Do not start the motors when there are people nearby.
- Always keep your hands on the remote controller so long as the motor is still spinning.
- **Stop motor mid-flight:** Pull the left stick to the bottom inside corner while simultaneously pressing the RTH button. Only stop motors mid-flight in emergency situations when doing so can reduce the risk of damage or injury. Refer to the user manual for details.

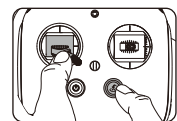

Stop motor mid-flight



It's important to understand basic flight guidelines, for the safety of both you and those around you. Don't forget to read the Disclaimer and Safety Guidelines.

Specifications

* Aircraft											
Weight (Battery & Propellers Included)	1388 g										
Max Ascent Speed	S-mode: 6 m/s; P-mode: 5 m/s										
Max Descent Speed	S-mode: 4 m/s; P-mode: 3 m/s										
Max Speed	45 mph (72 kph) (S-mode); 36mph (58 kph) (A-mode); 31 mph (50 kph) (P-mode)										
Max Service Ceiling Above Sea Level	19685 ft (6000 m)										
Max Flight Time	Approx. 30 minutes										
Operating Temperature	32° to 104° F (0° to 40° C)										
Satellite Positioning Systems	GPS/GLONASS										
Hover Accuracy Range	Vertical: ±0.1 m (With Vision Positioning); ±0.5 m (With GPS Positioning) Horizontal: ±0.3 m (With Vision Positioning); ±1.5 m (With GPS Positioning)										
* Gimbal											
Controllable Range	Pitch: -90° to +30°										
* Vision System											
Velocity Range	≤31 mph (50 kph) at 6.6 ft (2 m) above ground										
Altitude Range	0 - 33 ft (0 - 10 m)										
Operating Range	0 - 33 ft (0 - 10 m)										
Obstacle Sensory Range	2 - 98 ft (0.7 - 30 m)										
Operating Environment	Surfaces with clear patterns and adequate lighting (> 15 lux)										
* Infrared Sensing System											
Obstacle Sensory Range	0.6 - 23 ft (0.2 - 7 m)										
Operating Environment	Surface with diffuse reflection material, and reflectivity > 8% (such as wall, trees, humans, etc.)										
* Camera											
Sensor	1" CMOS; Effective pixels: 20M										
Lens	FOV (Field of View) 84°, 8.8 mm (35 mm format equivalent: 24 mm), f/2.8 - f/11, auto focus at 1 m - ∞										
ISO Range	Video: 100 - 3200 (Auto); 100 - 6400 (Manual); Photo: 100 - 3200 (Auto); 100 - 12800 (Manual)										
Mechanical Shutter	8 - 1/2000 s										
Electronic Shutter	8 - 1/8000 s										
Max Image Size	3:2 Aspect Ratio: 5472x3648; 4:3 Aspect Ratio: 4864x3648; 16:9 Aspect Ratio: 5472x3078										
Still Photography Modes	Single Shot Burst Shooting: 3/5/7/10/14 frames Auto Exposure Bracketing (AEB): 3/5 bracketed frames at 0.7EV Bias Interval: 2/3/5/7/10/15/30/60 s										
Video Recording Modes	H.265 <table border="0" style="width: 100%;"> <tbody> <tr> <td>•C4K: 4096x2160 24/25/30p</td> <td>•C4K: 4096x2160 24/25/30/48/50/60p</td> </tr> <tr> <td>•4K: 3840x2160 24/25/30p</td> <td>•4K: 3840x2160 24/25/30/48/50/60p</td> </tr> <tr> <td>•2.7K: 2720x1530 24/25/30/48/50/60p</td> <td>•2.7K: 2720x1530 24/25/30/48/50/60p</td> </tr> <tr> <td>•FHD: 1920x1080 24/25/30/48/50/60/120p</td> <td>•FHD: 1920x1080 24/25/30/48/50/60/120p</td> </tr> <tr> <td>•HD: 1280x720 24/25/30/48/50/60/120p</td> <td>•HD: 1280x720 24/25/30/48/50/60/120p</td> </tr> </tbody> </table>	•C4K: 4096x2160 24/25/30p	•C4K: 4096x2160 24/25/30/48/50/60p	•4K: 3840x2160 24/25/30p	•4K: 3840x2160 24/25/30/48/50/60p	•2.7K: 2720x1530 24/25/30/48/50/60p	•2.7K: 2720x1530 24/25/30/48/50/60p	•FHD: 1920x1080 24/25/30/48/50/60/120p	•FHD: 1920x1080 24/25/30/48/50/60/120p	•HD: 1280x720 24/25/30/48/50/60/120p	•HD: 1280x720 24/25/30/48/50/60/120p
•C4K: 4096x2160 24/25/30p	•C4K: 4096x2160 24/25/30/48/50/60p										
•4K: 3840x2160 24/25/30p	•4K: 3840x2160 24/25/30/48/50/60p										
•2.7K: 2720x1530 24/25/30/48/50/60p	•2.7K: 2720x1530 24/25/30/48/50/60p										
•FHD: 1920x1080 24/25/30/48/50/60/120p	•FHD: 1920x1080 24/25/30/48/50/60/120p										
•HD: 1280x720 24/25/30/48/50/60/120p	•HD: 1280x720 24/25/30/48/50/60/120p										
Video Storage Bitrate	100 Mbps										
Supported File Systems	FAT32 (≤ 32 GB); exFAT (> 32 GB)										
Photo	JPEG, RAW (DNG), JPEG + RAW										
Video	MP4/MOV (AVC/H.264; HEVC/H.265)										
Supported SD Cards	Micro SD, Max Capacity: 128 GB. Class 10 or UHS-1 rating required										
Operating Temperature	32° to 104° F (0° to 40° C)										
* Remote Controller											
Operating Frequency	2.400 - 2.483 GHz and 5.725 - 5.825 GHz										
Max Transmission Distance	FCC: 4.3 mi (7 km); CE: 2.2 mi (3.5 km); 3.1 mi (5 km) (Unobstructed, free of interference)										
Operating Temperature	32° - 104° F (0° - 40° C)										
Battery	6000 mAh LiPo 2S										
Transmitter Power (EIRP)	2.4 GHz: 26 dBm (FCC); 17 dBm (CE); 20 dBm (SRRC) 5.8 GHz: 28 dBm (FCC); 14 dBm (CE); 20 dBm (SRRC)										
Operating Voltage	1.2 A @ 7.4 V										
* Charger											
Voltage	17.4 V										
Rated Power	100 W										
* Intelligent Flight Battery (PH4-5870mAh-15.2V)											
Capacity	5870 mAh										
Voltage	15.2 V										
Battery Type	LiPo 4S										
Energy	89.2 Wh										
Net Weight	468 g										
Charging Temperature Range	41° to 104° F (5° to 40° C)										
Max Charging Power	100 W										

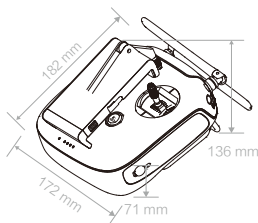
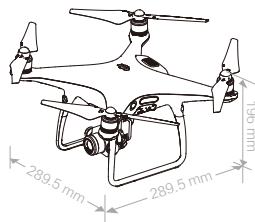

Download the user manual for more information:
<http://www.dji.com/phantom-4-pro>



PHANTOM™ and DJI™ are trademarks of DJI.
 Copyright © 2016 DJI All Rights Reserved.

Designed by DJI. Printed in China.

※ This Quick Start Guide is subject to change without prior notice.

PHANTOM 4 PRO