

**FUJIFILM**

# instax<sup>®</sup> mini LiPlay

**HYBRID INSTANT CAMERA**

[INSTANT PRINT + DIGITAL TECHNOLOGIES]

**User's Guide (Full version)**



## Table of Contents

Before Use.....	3	Various Types of Shooting .....	15
Notes on Disposing of the Camera .....	3	Shoot Using the Self-timer.....	15
About This Camera .....	3	Shooting Using the Flash .....	15
Main Features .....	3	Taking a Photo of Yourself (Selfie) .....	16
Functions Available with the Smartphone App.....	3	Shooting Using the AF/AE Lock .....	16
Part Names.....	4	Printing from Print History .....	17
LCD Monitor.....	5	Using a Memory Card .....	17
Using the Cross Key.....	6	Inserting a Memory Card.....	17
Attaching the Strap.....	6	Using the Shooting Menu .....	18
Charging the Battery .....	7	Using the Playback Menu .....	19
Charging Status Indication .....	7	Using the Set-up Menu.....	19
Powering on/off.....	7	Functions Available by Linking with the Smartphone App.....	20
Checking the Battery Level.....	7	Sound Function.....	20
Initial Settings .....	8	Remote Shooting Function.....	20
Loading/Unloading the "INSTAX mini" Film Pack.....	9	Shortcut Function.....	20
Loading the Film Pack.....	9	Direct Print Function.....	20
Unloading a Used Film Pack .....	10	Specifications .....	21
Basic Shooting and Playback .....	10	Troubleshooting .....	22
Shooting .....	10	IMPORTANT SAFETY NOTICE.....	23
Playing Back Images.....	11	Simple Camera Care .....	23
Changing the Playback Screen Display .....	11	Bluetooth® Devices: Cautions.....	24
Printing.....	12		
Remaining Film Indicator .....	13		
Selecting the Frame and Filter .....	13		
Selecting the Frame .....	13		
Selecting the Filter.....	13		
Adding Sound to Images .....	14		
Adding Sound When Shooting .....	14		
Adding Sound When Playing Back .....	15		

## Before Use

Before using the camera, check the following has been included.

### Supplied Accessories

- USB cable for charging (1)
- Strap (1)

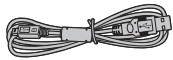

- User's Guide (1)

## Notes on Disposing of the Camera

A built-in lithium ion battery is used for this camera.

When you dispose of the camera, follow your local regulations and dispose of it properly.

Please refer to the supplied CONTACT INFORMATION sheet for inquiry.

If your country or region is not included in the sheet, please contact your local distributor.

### CAUTION

Do not remove the built-in battery by yourself; otherwise, you may be injured.



Disposal of Electric and Electronic Equipment in Private Households  
 Disposal of used Electrical & Electronic Equipment  
 (Applicable in the European Union and other European countries with separate collection systems)

This symbol on the product, or in the manual and in the warranty, and/or on its packaging indicates that this product shall not be treated as household waste. Instead it should be taken to an applicable collection point for the recycling of electrical and electronic equipment.

By ensuring this product is disposed of correctly, you will help prevent potential negative consequences to the environment and human health, which could otherwise be caused by inappropriate waste handling of this product.

The recycling of materials will help to conserve natural resources. For more detailed information about recycling of this product, please contact your local city office, your household waste disposal service or the shop where you have purchased the product.

In Countries outside of EU: If you wish to discard this product, please contact your local authorities and ask for the correct way of disposal.



This Symbol on the batteries or accumulators indicates that those batteries shall not be treated as Household waste.

For customers in Turkey:

EEE Complies with Directive.

## About This Camera

### Main Features

- The "INSTAX mini LiPlay" is the most compact INSTAX product available on the market.
- You can perfectly position your photo using the LCD monitor and save the image onto the camera memory or micro SD card.
- You can select a photo from your photo library and print it using the INSTAX print feature.
- You can edit your photos by using 10 photo frames and 6 filters.
- You can save your photos with the recorded sound.
- Stylish and luxurious design.
- Equipped with selfie mirror to easily position selfies.

### Functions Available with the Smartphone App

- **Sound function**  
Record sound with the camera, convert it to QR code and print the QR code on a photo (Print with sound). Sound is played when QR codes printed with the INSTAX print feature are read with your smartphone.
- **Remote shooting function**  
Control the camera with your smartphone for remote shooting of photos.
- **Shortcut function**  
You can select photo frames on your smartphone and assign the frames to the 3 shortcut buttons located on the side of the camera.
- **Direct print**  
Transfer a photo from your smartphone to the camera, and print it with the INSTAX print feature. Before sending the photo, you can use the smartphone app to move, rotate, zoom in, zoom out, or crop the photo.





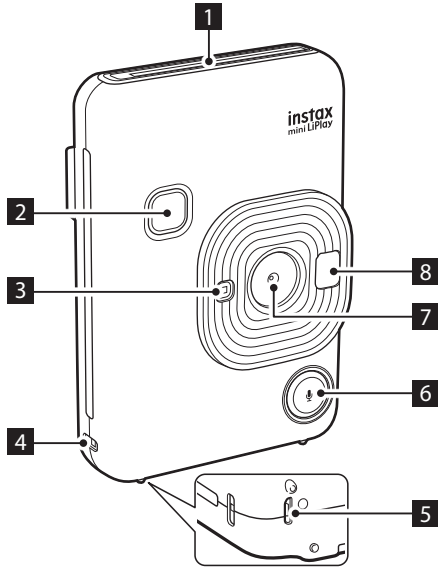

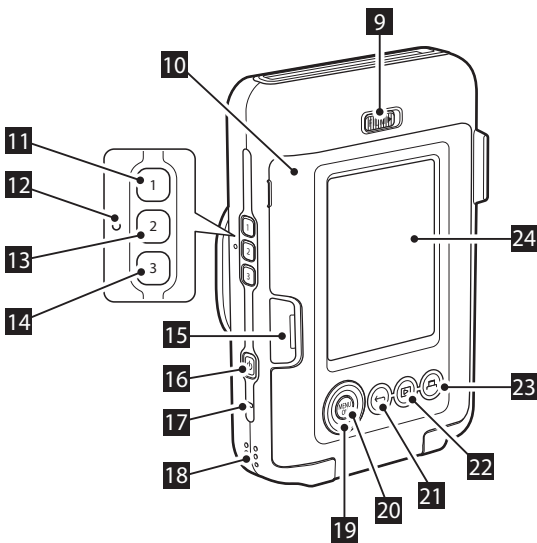

## Part Names

### Front



### Rear





- 1 Film ejection slot
- 2 Shutter button
- 3 Flash/Self-timer lamp
- 4 Strap hook
- 5 USB port
- 6  (Sound) button
- 7 Lens
- 8 Selfie mirror
- 9 Film door lock
- 10 Film door
- 11  (Shortcut 1) button
- 12 Reset button\*
- 13  (Shortcut 2) button
- 14  (Shortcut 3) button
- 15 Micro SD card slot
- 16  (Power) button
- 17 Microphone
- 18 Speaker
- 19 Cross key ()
- 20 MENU/OK button
- 21  (Back) button
- 22  (Playback) button
- 23  (Print) button
- 24 LCD monitor

\*If the camera does not work properly, press the reset button to reset the camera.

## LCD Monitor

The shooting screen displays on the LCD monitor when the power is switched on.

- To switch from the shooting screen to the playback screen, press  (Playback).
- To switch from the playback screen to the shooting screen, press the shutter button.

While the shooting screen or playback screen is displayed, press  (Back) to display the following information on the LCD monitor.

### Shooting screen

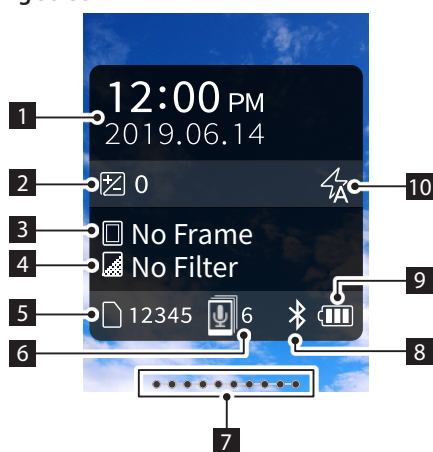

### Playback screen

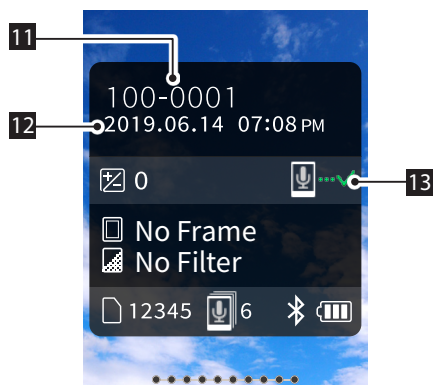

- 1 Current date and time
- 2 Exposure
- 3 Frame name
- 4 Filter name
- 5 Number of images available\*
- 6 Number of prints with sound images waiting to be sent
- 7 Remaining film indicator
- 8 Bluetooth connection status indicator
- 9 Battery level indicator
- 10 Flash indicator
- 11 Frame No. indicator
- 12 Shooting date/time information
- 13 Transmission status indicator of print with sound images







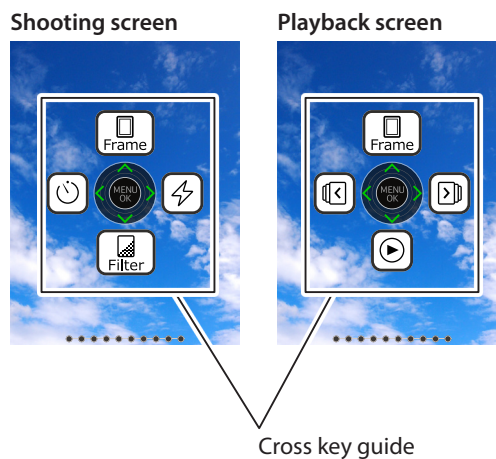

\*When using the internal memory,  is displayed. The icon displays in red when the number of available images is 10 or less.

### ■ Cross Key Guide Display





When starting up or switching screens (Shooting screen ↔ Playback screen), the cross key guide appears for a short time.

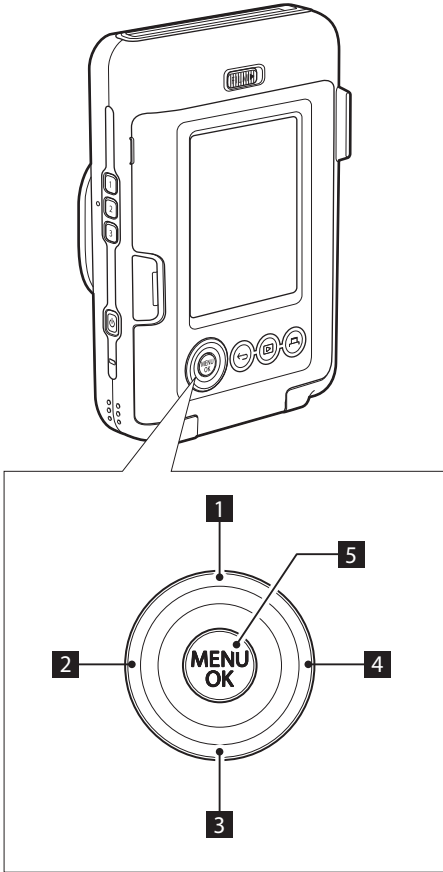

## Using the Cross Key

The     (up, down, left, and right) keys are used to select menu items, or to recall the functions assigned to the     keys. The [MENU/OK] button is used to display the menu or to make a selection.



- 1  Move up
- 2  Move left
- 3  Move down
- 4  Move right
- 5 Menu display/Make selection

## Attaching the Strap

Attach the strap as shown below.

- Put the strap around your wrist when carrying the camera or taking photos to avoid dropping the camera.

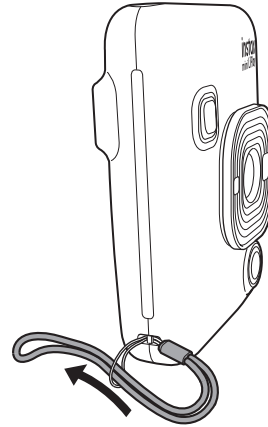

## Charging the Battery

- ❗ Turn off the camera before charging the battery. Battery will not charge if the camera is powered on.
- ❗ Ensure USB is correctly attached as indicated.

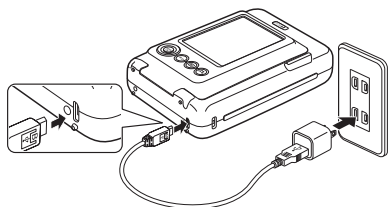

Connect the camera and a USB AC adapter supplied with your smartphone using the supplied USB cable, then connect the USB AC adapter to an indoor power outlet.

- Charging time is approximately 2 to 3 hours.

## Charging Status Indication

While charging	Self-timer lamp lights up.
Charging finished	Self-timer lamp goes off.
Charging error	Self-timer lamp flashes.

### Charging from a PC:

- Connect the camera and PC directly. Do not connect via a USB hub or keyboard.
- If the PC goes into sleep mode while charging, charging is discontinued. To continue charging, exit sleep mode and then reconnect the USB cable.
- The battery may not charge depending on the specifications, settings or conditions of the PC.

### Note

- The battery cannot be removed.
- The battery has not been charged during manufacture. Please charge the battery fully before use.
- For notes about the battery, please refer to "Simple Camera Care". (p. 23)



## Powering on/off

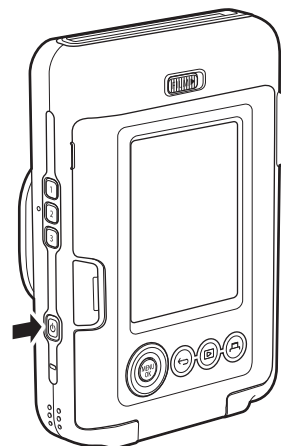

Press and hold  (Power) to power on or off.



## Checking the Battery Level

The battery level is displayed on the LCD monitor when pressing  (Back) on the shooting screen or playback screen.

Display	Battery level
	There is sufficient charge remaining.
	The remaining charge is half or less. Charging is recommended.
	There is not sufficient charge remaining. Please charge as soon as possible.

- When the battery level is low, the  icon displays at the bottom right of the LCD monitor.
- When the battery runs out completely, the  icon appears on the LCD monitor and the power is turned off.

- If you do not use the camera for a certain period of time, it will turn off automatically. You are able to set the amount of time until the power is turned off. (p. 20)
- During shooting mode, press  (Playback) to display the playback screen and enter playback mode.
- Press the shutter button fully during playback mode to display the shooting screen and select shooting mode.

## Initial Settings

When turning the camera on for the first time after purchase, a screen will be displayed automatically to set the language, date and time, and also to pair a smartphone.

Please install the "INSTAX mini LiPlay" app on your smartphone before carrying out pairing registration.

- If you are using an Android OS smartphone, please search for "INSTAX mini LiPlay" in Google Play Store and install it.

\*Requirements for Android OS smartphones: Android Ver. 5.0 or higher with Google Play Store installed

- If you are using an iOS smartphone, please search for "INSTAX mini LiPlay" in the App Store and install it.

\*Requirements for iOS smartphones: iOS Ver. 10 or higher

Depending on your smartphone model, you may not be able to use "INSTAX mini LiPlay" even if you have installed it and your smartphone meets the above requirements.

This setting can also be configured later. If you want to configure the settings later or reconfigure the settings, set the [言語/LANG.], [DATE/TIME] and [Bluetooth SETTINGS] in the SET-UP MENU.

### 1 Turn on the power

- When you turn on the power for the first time after purchase, the Language Setting (言語/LANG.) screen is displayed.

### 2 Select the language you wish to use and press [MENU/OK]

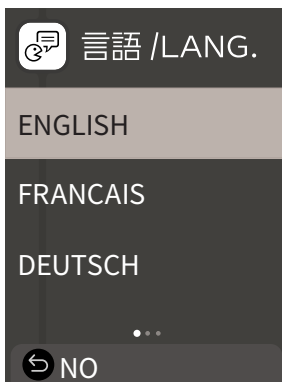

### 3 Set the date order and press [MENU/OK]

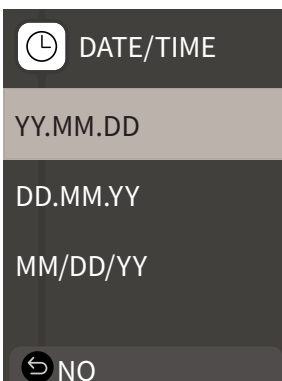

### 4 Set the year, month, day, hour and minute then press [MENU/OK]

Move the cursor by using , then change the number using .

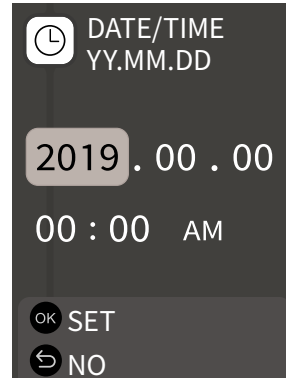

Next, configure the pairing settings.

### 5 Press [MENU/OK]

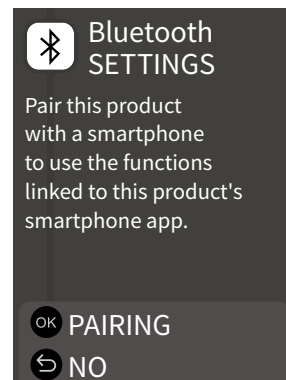

- If you do not wish to set pairing, press (Back) to finish the initial settings.

### 6 Launch the smartphone app "INSTAX mini LiPlay" and press [SETTINGS]

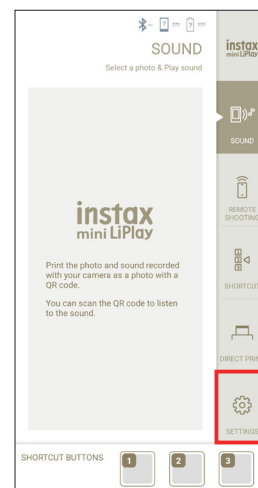

**7 Press [Bluetooth settings] on the smartphone app**

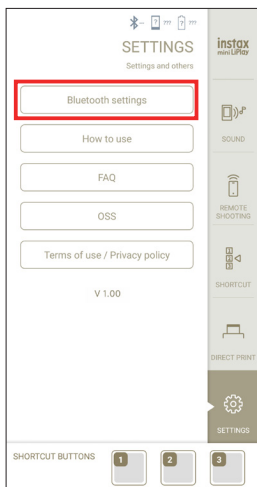

**8 Press [Connect] on the smartphone app**

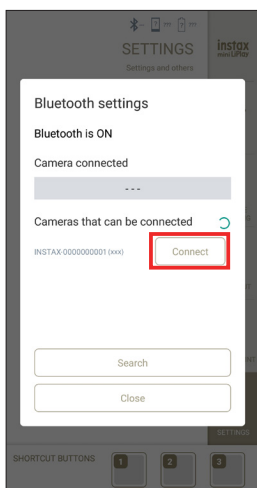

• You can confirm camera's OWN NAME by accessing the Set-up Menu. (p. 19) Next, select the menu items in the following order: [Bluetooth SETTINGS], [INFORMATION], [OWN NAME].

**9 Allow pairing**

**10 Confirm that pairing registration is complete**

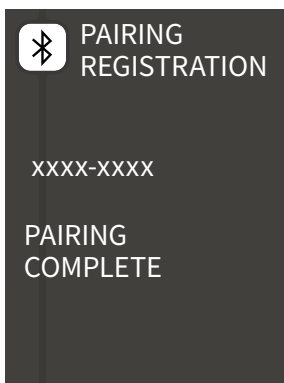

When pairing registration is complete, the screen changes to the shooting screen.

**Loading/Unloading the "INSTAX mini" Film Pack**

**Loading the Film Pack**

**1 Slide the film door lock and open the film door**

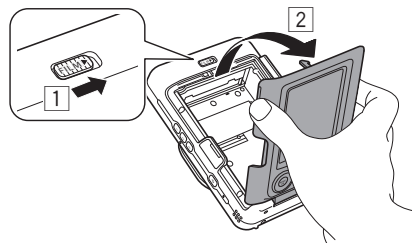

**2 Insert film pack by aligning the yellow marks**

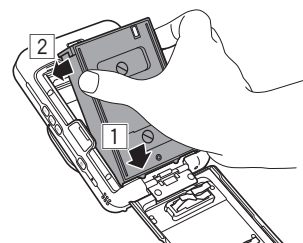

**3 Close the film door**

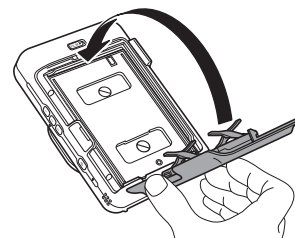

**4 Remove the black film cover that is automatically rejected**

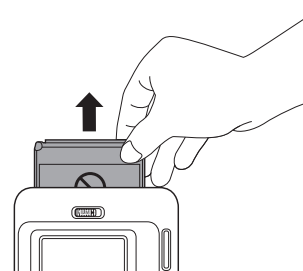

## Unloading a Used Film Pack

- 1 Slide the film door lock and open the film door

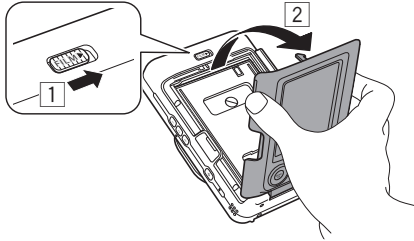

- 2 Grasp the rectangular holes on the film pack, then pull film pack out from the camera

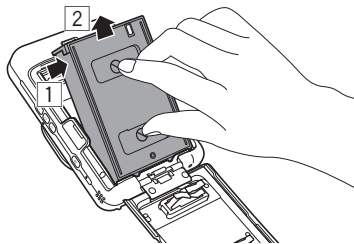

## Basic Shooting and Playback

### Shooting

The following steps describe the basic shooting procedure.

- 1 Turn on the power
- 2 Hold the camera
- 3 Configure the frame and filter, etc. as needed
- 4 Decide the composition to shoot
- 5 Press the shutter button halfway to focus on the subject

When the subject is in focus

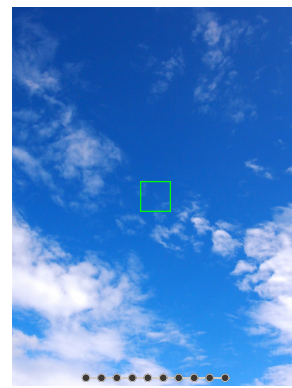

A beep will sound and the green AF frame will display on LCD monitor.

When the subject is not in focus

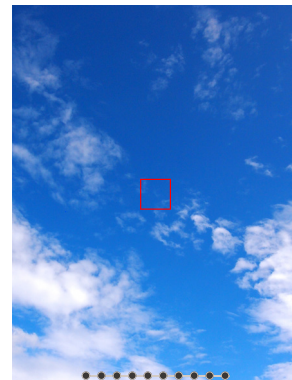

A red AF frame will display on the LCD monitor. Either change the composition or use the AF/AE lock. (p. 16)

- 6 Press the shutter button down fully to take a photo  
The photo is taken and the image is saved to the internal memory or memory card.
  - For the steps on how to print an image you have taken, please refer to "Printing". (p. 12)



- When shooting, steady your arms against your body and hold the camera firmly with both hands.
- Be careful not to touch the camera lens when pressing the shutter button.
- Gently press the shutter button fully to take a picture, ensuring that the camera does not move or shake.
- Be careful not to cover the flash or lens with your fingers or the strap.
- The flash may fire when you fully press the shutter button to take a picture in low light or backlit conditions. You can change the flash settings so that the flash does not fire. (p. 16)

#### Notes on the internal memory

- When the internal memory is full, the shutter does not release and you cannot shoot photos. Please delete some images or use a memory card.
- If the camera experiences a malfunction, images in the internal memory may be corrupted or lost.
- It is recommended that you copy important images to another media format (Hard disk, CD-R, CD-RW, DVD-R, etc.) as a backup.
- If you submit your camera for repair, we cannot guarantee the integrity of the data in the internal memory.
- When repairing the camera, we may need to check the data in the internal memory.

### Playing Back Images

You can play back images on the LCD monitor.

- 1 Turn on the power**
- 2 Press  (Playback)**  
The last image taken is displayed.
- 3 Press  or  to select the image you want to play back**
  - Press the shutter button fully to return to the Shooting screen.

### Changing the Playback Screen Display

You can zoom in on the image and change the number of images displayed on the LCD monitor.

#### ■ Zooming images

- 1 Select the image you want to zoom in on and press [MENU/OK]**

The playback menu is displayed.

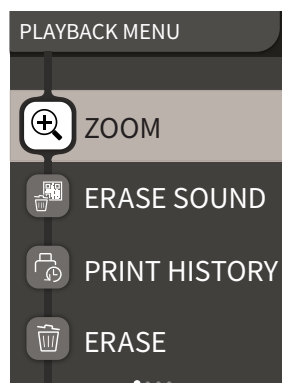







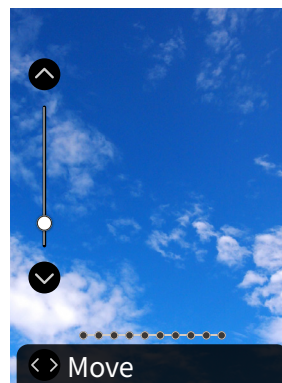

- 2 Press  or  to select [ZOOM]**

- 3 Press [MENU/OK]**

The zoom screen is displayed.

- 4 Zoom in or out of the image with  and **



- Press  or  on the zoom screen to switch to the move screen and move the screen position using , , , and . To return to the zoom screen, press  (Back).
- If you press [MENU/OK] whilst in the zoom or move screen, the screen will return to the playback screen.
- You can also print with the image zoomed in or zoomed out.





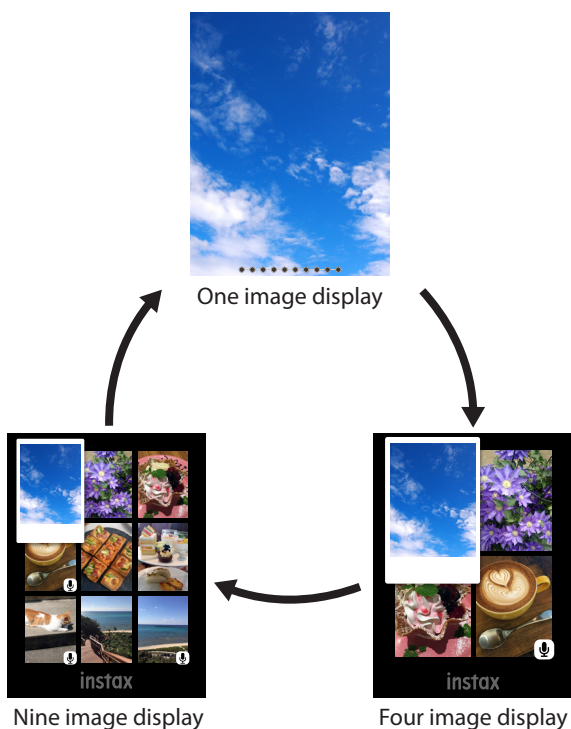

## ■ Change the Number of Images Displayed

While displaying the playback screen, press  (Playback) to change the number of images displayed.



## Printing





You can print the images using the following procedure.

- 1 Turn on the power**
- 2 Press  (Playback)**  
The last image taken is displayed.
- 3 Press  or ** to select the image you want to print
- 4 Select desired settings such as frame and zoom**
- 5 Press  (Print)**
- 6 Press  or ** to select [PRINT] or [PRINT WITH SOUND]

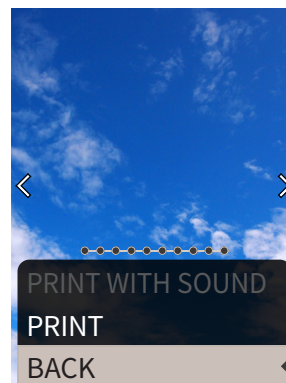
### Note

To print with sound, it is necessary to link with the sound function of the smartphone app.



- 7 Press [MENU/OK]**  
Printing starts.
  - To print with sound, use     to change the print position of the QR Code as needed.
  - To cancel printing, select [BACK] or press  (Back).
- 8 When the sound of film unloading stops, hold the top of the film and remove it**

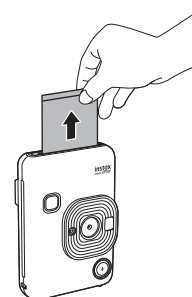

### Note

Be careful not to obstruct the film ejection slot with your fingers or the strap.

### Remaining Film Indicator

The remaining number of film is indicated by the dots at the bottom of the screen. Each time a film is printed, a dot changes to a small square. The dots will display in red when the number of film remaining is 2 or less.

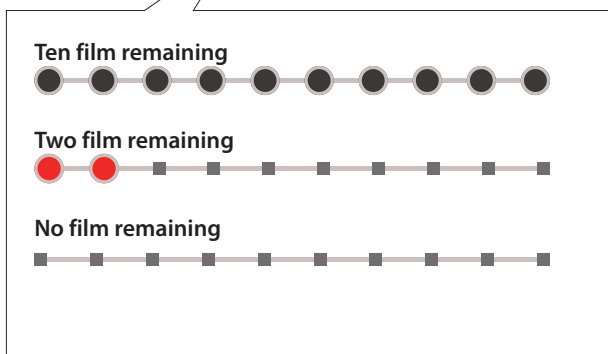
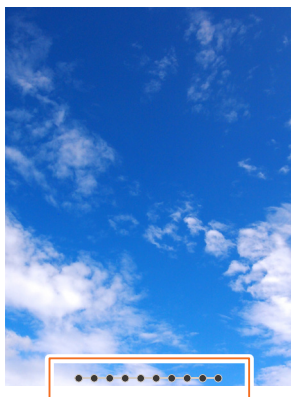

- For handling of the film, please refer to the FUJIFILM Instant Film "INSTAX mini" instruction manual.
- Film development takes about 90 seconds (the time varies depending on the ambient temperature).

## Selecting the Frame and Filter

### Selecting the Frame

Follow the procedure below to select the frame type.

- 1 On the shooting screen or playback screen, press . The following guide is displayed.

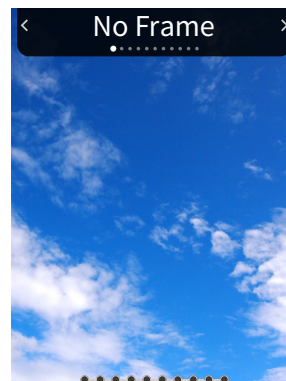

- 2 Press or to select the frame type
- 3 Press or [MENU/OK]
  - The frame is applied and the display returns to the previous screen.
  - Press (Back) to return to the previous screen without applying the frame.
  - To cancel the frame you have applied, select "No Frame" under frame type.

You can also press a shortcut button to select the frame assigned to that button.

### Selecting the Filter

Follow the procedure below to select the filter type.

- 1 On the shooting screen, press . The following guide is displayed.

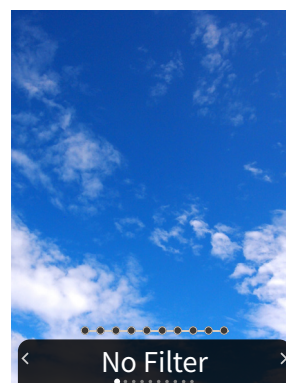

- 2 Press or to select the filter type

### 3 Press or [MENU/OK]

The filter is applied and the display returns to the previous screen.

- Press  (Back) to return to the previous screen without applying the filter.
- To cancel the filter you have applied, select “No Filter” under filter type.

## Adding Sound to Images

This camera can attach recorded sound to images.

### Adding Sound When Shooting

#### 1 Whilst in the shooting screen, press and hold the (Sound) button

Sound mode starts, and a recording animation is displayed at the bottom of the screen.

- When you press and hold the  (Sound) button for the first time after turning on the power, the sound mode function description is displayed for a short time before sound mode starts.

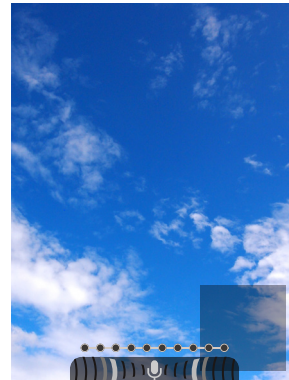

#### 2 Press the shutter button halfway to focus on the subject

#### 3 Press the shutter button down fully

Sound will be recorded for 5 seconds before and 5 seconds after you press the shutter button fully.



- To exit sound mode, press the  (Sound) button again.

## Adding Sound When Playing Back

### 1 On the single images playback screen, press and hold the (Sound) button

Sound mode starts, and a recording icon is displayed in the center of the screen.





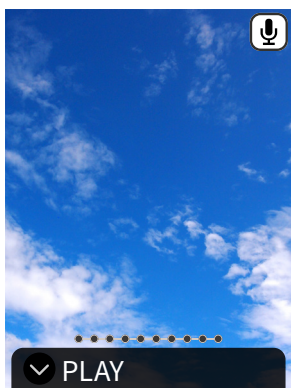

- Sound is recorded for about 10 seconds after you press and hold the  (Sound) button.
- If you press and hold the  (Sound) button while displaying an image with sound, the message "Are you sure you want to overwrite this recording?" is displayed. To overwrite, select [CONFIRM]. Otherwise, select [BACK].

### 2 Press button to confirm the recorded sound

The recording is played back.



- Press  to pause the sound during playback, or press  to stop playback.
- Press [MENU/OK] during playback to display the Adjust Playback Volume screen. You can also adjust the volume by pressing  or .

## Various Types of Shooting

### Shoot Using the Self-timer

Use the self-timer for group photos or to prevent the camera from shaking.

#### 1 On the shooting screen, press

The following guide is displayed.



#### 2 Press or to select [2 SEC] or [10 SEC]

#### 3 Press [MENU/OK] or

An icon showing the self-timer length that has been set will display in the upper right of the screen.

- Press  (Back) to return to the previous screen without applying the setting.

#### 4 Fully press the shutter button

**If you selected [2 SEC]:**

When you press the shutter button, the self-timer lamp blinks.

**If you selected [10 SEC]:**

When you press the shutter button, the self-timer lamp lights up and blinks for 3 seconds before shooting.

Press  (Back) to cancel the self-timer.

### Shooting Using the Flash

Use the flash to shoot at night or in dark environments. You can change the flash setting to prevent the flash from firing.

#### 1 On the shooting screen, press

The following guide is displayed.

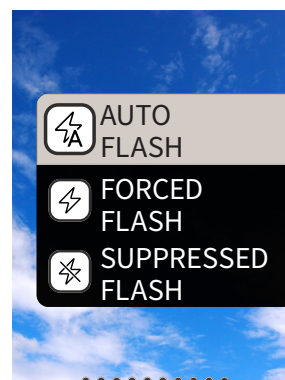

## 2 Press or to select the flash setting

- For details about the flash settings, please refer to “Types of Flash”.

## 3 Press [MENU/OK] or

## 4 Fully press the shutter button

- If you press the shutter button whilst the flash is charging, the self-timer lamp will blink and the shutter will not release.

### ■ Types of Flash

#### Auto flash

The flash fires automatically if the surroundings are dark. This setting is suitable for most situations.

#### Forced Flash

The flash fires regardless of the surrounding brightness. Use when the subject is dark due to backlighting.

#### Suppressed Flash

The flash does not fire even when the surroundings are dark.

This setting is suitable for shooting in places where flash photography is prohibited.

It is recommended to stabilize the camera on a table, etc. when using suppressed flash in dark surroundings.

### Taking a Photo of Yourself (Selfie)

You can take a photo of yourself using the selfie mirror.

## 1 Hold the camera firmly with the lens 30cm to 50cm from your face

- Hold the camera firmly, as it is particularly prone to camera shake in dark environments.

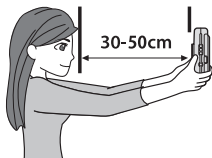

## 2 Check your composition in the selfie mirror and shoot

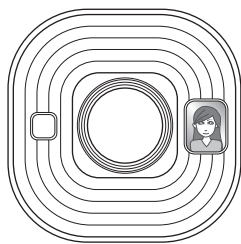

- Do not stare at the flash when shooting. Staring at the flash may temporarily effect vision.

### Shooting Using the AF/AE Lock

When shooting, holding the shutter button halfway locks the focus, called “AF lock”. The brightness or exposure will also be locked called “AE lock”. This will be useful when you want to place the subject outside the center of the screen whilst shooting.

## 1 Press the shutter button halfway to focus on the subject

When you press the shutter button halfway, AF and AE are locked.

## 2 Decide upon your composition while pressing the shutter button halfway

## 3 Press the shutter button fully to shoot







It is recommended to use the AE/AF lock when shooting the following subjects, as they can be difficult to focus on.

- Shiny subjects such as a mirror or car body
- Subjects that are moving at high speed
- Subjects on the other side of a glass
- Dark subjects that absorb light without reflecting it such as hair or fur
- Non-solid subjects such as smoke or flames
- Subject with little contrast with the background (such as a person wearing clothes with the same color as the background)
- When there is a large contrast difference in the AF frame and the subject is close to it (such as a subject in front of a background with a strong contrast)

## Printing from Print History

You can find images printed previously and retain the settings (such as image effects) for printing.





You can print the images you have taken previously using the following procedure.

- 1 Press [MENU/OK] on the playback screen**  
The playback menu is displayed.
- 2 Press  or  and select [PRINT HISTORY]**
- 3 Press [MENU/OK]**
- 4 Press  or  to select the image you want to print**
- 5 Press  (Print)**
- 6 Press  or  to select [PRINT] or [PRINT WITH SOUND]**

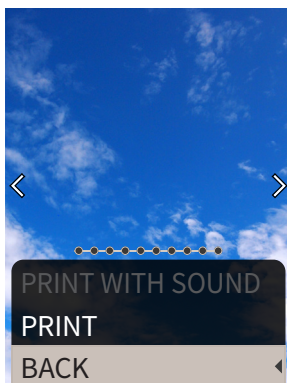
### Note

To print with sound, it is necessary to link with the sound function of the smartphone app.



- 7 Press [MENU/OK]**  
Printing starts.
  - To print with sound, use , , , and  to change the print position of the QR Code as needed.
  - To cancel printing, select [BACK] or press  (Back).
- 8 When the sound of the film unloading stops, hold the top of the film and remove it**

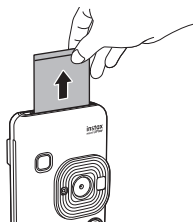

### Note

Be careful not to obstruct the film ejection slot with your fingers or the strap.

## Using a Memory Card

The camera can save approximately 45 images in the internal memory, but you can save more images by using a memory card.

### Notes on memory card

- Micro SD and micro SDHC memory cards are compatible with this camera. Using a memory card other than the specified type may cause damage to the camera.
- Because memory cards are small, infants may accidentally swallow them. Keep out of reach of children. Please consult your doctor immediately if an infant swallows a memory card.
- **Do not turn off the camera or remove the memory card while formatting the memory card or recording or erasing data. Doing so may damage the memory card.**
- Do not use or store a memory card in an environment prone to strong static electricity or electrical noise.
- If you insert a memory card charged with static electricity into the camera, the camera may malfunction. If this happens, turn off the power and then turn it on again.
- Do not put a memory card in your trouser pocket. When you sit down, stress may be applied to the memory card causing it to break.
- When you remove a memory card after prolonged use, it may be warm, but this is normal.
- Do not attach labels, etc. onto memory cards. Labels may become unattached from the memory card whilst being inserted and removed from the camera which may cause the camera to malfunction.

### Notes on using a memory card in a PC

- Be sure to use the camera to format unused memory cards and memory cards used on the PC and other devices before use.
- When you format a memory card with the camera, shoot and record images, a folder is automatically created. Do not use a computer to change or delete the memory card folder names or file names. The memory card may become unusable by the camera.
- Please do not use the PC to delete images from the memory card. Always use the camera to delete images from the memory card.
- When editing an image file, copy or move the image file to a hard disk, etc. for editing.

## Inserting a Memory Card

- 1 Open the card slot cover**

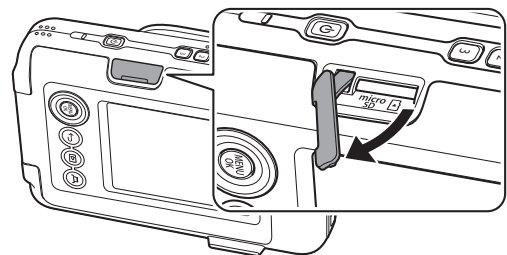

- 2 Insert the memory card all the way until a click is heard. Ensure the correct orientation is used as shown below

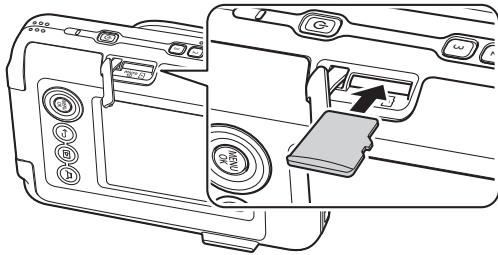

- 3 Close the card slot cover

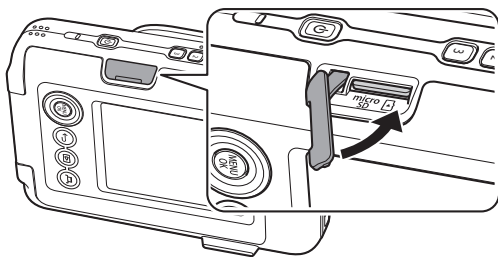

- When removing a memory card, push against the memory card with your finger and slowly release your finger from the card. The lock is released and the memory card can be removed.

**Note**

Take care when removing a memory card, it may be ejected forcefully if you release your finger suddenly. Please release the card gently.

## Using the Shooting Menu

You can change various settings related to shooting from the shooting menu.

- 1 Press [MENU/OK] on the shooting screen  
The shooting menu displays.

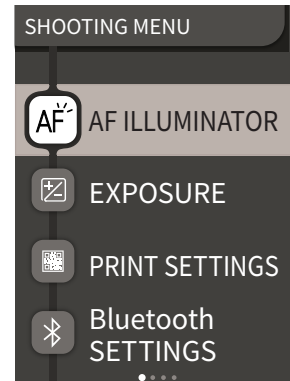

- 2 Press or to select the item to set
  - For a description of each item, please refer to “Shooting Menu Items”.
- 3 Change the settings
- 4 Press [MENU/OK]  
The settings are applied and the display returns to the shooting screen.

### ■ Shooting Menu Items

#### [AF ILLUMINATOR]

If you select ON, the AF Illuminator will be lit during the period from when you press the shutter button halfway until the subject is in focus, making it easier to focus on dark subjects.

- Depending on the scene, it may be difficult to focus even if the flash is used.
- When shooting close to the subject, the effect of the AF Illuminator may not be sufficient.
- Do not use the AF illuminator in close proximity to human eyes.

#### [EXPOSURE]

Adjust the brightness of the image. Exposure is used when the subject is too bright or too dark, or when the contrast between the subject and the background (difference in brightness) is large.

- The set exposure value is retained even after moving the image data to a PC, etc.

For a description of the following items, please refer to “Using the Set-up Menu”. (p. 19)

[PRINT SETTINGS] / [Bluetooth SETTINGS] / [CROSS KEY GUIDE] / [DATE/TIME] / [言語/LANG.] / [SOUND SET-UP] / [PLAYBACK VOLUME] / [AUTO POWER OFF] / [RESET] / [FRAME DATA RESET] / [FORMAT] / [FIRMWARE UPGRADE]

## Using the Playback Menu

You can change various settings related to playback from the playback menu.

### 1 Press [MENU/OK] on the playback screen

The playback menu is displayed.

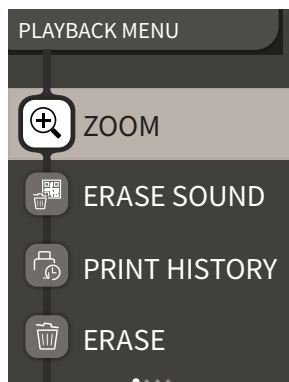

### 2 Press $\blacktriangle$ or $\blacktriangledown$ to select the item

• For a description of each item, please refer to “Playback Menu Items”.

### 3 Change the settings

### 4 Press [MENU/OK]

The settings are applied and the display returns to the previous screen.

#### ■ Playback Menu Items

##### [ZOOM]

Please refer to “Zooming images”. (p. 11)

##### [ERASE SOUND]

Erases only the sound from images with sound.

##### [PRINT HISTORY]

- Display up to the last 50 images that were printed.
- Select an image and press  $\square$  (Print) to start printing.
- You can clear the print history one image at a time by pressing [MENU/OK].

##### [ERASE]

You can erase images one by one or erase them all at once.

##### [IMAGE ROTATE]

Display an image rotated by 90 degrees.

##### [COPY]

Copy images from the internal memory to a memory card or from a memory card to the internal memory.

Follow the procedure below.

1. Select [COPY] from the playback menu
2. Select the copy destination and press [MENU/OK]
3. Select [FRAME] or [ALL FRAMES] and press [MENU/OK]  
If you selected [ALL FRAMES], copying starts. If you selected [FRAME], proceed to step 4.
4. Press  $\blacktriangle$  or  $\blacktriangledown$  to select the image to copy
5. Press  $\blacktriangle$  or  $\blacktriangledown$  to select [COPY]
6. Press [MENU/OK]

For a description of the following items, please refer to “Using the Set-up Menu”. (p. 19)

[PRINT SETTINGS] / [Bluetooth SETTINGS] / [CROSS KEY GUIDE] / [DATE/TIME] / [言語/LANG.] / [SOUND SET-UP] / [PLAYBACK VOLUME] / [AUTO POWER OFF] / [RESET] / [FRAME DATA RESET] / [FORMAT] / [FIRMWARE UPGRADE]

## Using the Set-up Menu

Follow the procedure below to change settings with the set-up menu.

### 1 On the shooting screen or playback screen, press [MENU/OK]

### 2 Press $\blacktriangle$ or $\blacktriangledown$ to select the item to set

• For a description of each item, please refer to “Set-up Menu Items”.

### 3 Change the settings

### 4 Press [MENU/OK]

The settings are applied and the display returns to the previous screen.

#### ■ Set-up Menu Items

##### [PRINT SETTINGS]

Change the print position and print color of the QR Code printed on print with sound.

##### Note

To print with sound, it is necessary to link with the sound function of the smartphone app.

##### [Default QR Code Position]:

Change the default QR code position.

##### [QR Code Color]:

Change the QR Code printing color.

##### [Bluetooth SETTINGS]

Please install the smartphone app on your smartphone before pairing registration.

##### [PAIRING REGISTRATION]:

When you connect with your smartphone via Bluetooth for the first time, you will need to pair the devices. Please refer to the following procedure for pairing.

1. Select [Bluetooth SETTINGS] from the playback menu
2. Select [PAIRING REGISTRATION] and press [MENU/OK]
3. Press [SETTINGS] on the smartphone app
4. Press [Bluetooth settings] on the smartphone app
5. Press [Connect]
6. Allow pairing

##### [DELETE PAIRING REG.]:

You can delete information of a smartphone registered for pairing.

##### [INFORMATION]:

Displays the Bluetooth address, name, and registered terminal name of the main unit.

##### [CROSS KEY GUIDE]

Sets whether to show or hide the cross key guide.

#### [DATE/TIME]

Set the date and time.

#### [言語/LANG.]

Set the language to be displayed on the LCD monitor.

#### [SOUND SET-UP]

Set the volume of the operation sound, shutter volume and start up sound.

Select [OFF] if you want to turn off the sound.

#### [PLAYBACK VOLUME]

Set the playback volume of the recorded sounds.

#### [AUTO POWER OFF]

Sets the time until the power is automatically turned off when the camera is not in use.

#### [RESET]

Resets the settings to the default settings.

The date and time set in date/time are not reset.

#### [FRAME DATA RESET]

Resets the default frame settings used for the shortcut buttons.

#### [FORMAT]

Format the camera's internal memory or a memory card inserted in the card slot. All saved images will be deleted.

#### [FIRMWARE UPGRADE]

Upgrade the firmware version.

Insert the memory card containing the firmware into the card slot and follow the instructions on the screen.

Download the latest firmware from the FUJIFILM website.

## Functions Available by Linking with the Smartphone App

The following functions can be used by linking with the smartphone app "INSTAX mini LiPlay".

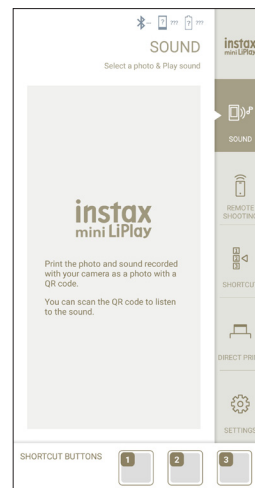

### Sound Function

You can convert the sound recorded by the camera into a QR Code and print it together with an image (Print with sound).

- The sound is played when the QR code printed with a sound image is read by a smartphone, etc.
- You can play or delete the sound on images with sound that you have previously printed using the smartphone app.

#### Note

If you delete an image with sound using the smartphone application, the sound will no longer be able to be played even if the QR Code is read.

### Remote Shooting Function

You can set flash and self-timer options with the smartphone app and shoot remotely.

### Shortcut Function

The three shortcut buttons on the side of the camera can be set in the smartphone app.

### Direct Print Function

You can send an image from your smartphone to the camera and print it with the INSTAX printing function. Before sending, you can move, rotate and zoom the image with the smartphone app.

## Specifications

### ■ Camera Function

Image sensor	1/5 type CMOS primary color filter
Number of recorded pixels	2560 × 1920 pixels
Storage media	Internal memory, micro SD/micro SDHC memory card
Storage capacity	Approximately 45 images in internal memory, approximately 850 images per 1 GB in micro SD/micro SDHC memory card
Recording method	DCF compliant Exif Ver 2.3
Focus distance	f = 28 mm (35 mm film equivalent)
Aperture	F2.0
Auto focus	Single AF (with AF Illuminator)
Shooting distance	10 cm to ∞
Shutter speed	1/4 second to 1/8000 second (automatic switching)
Shooting sensitivity	ISO100 to 1600 (automatic switching)
Exposure control	Program AE
Exposure	-2.0 EV to +2.0 EV (1/3 EV step)
Metering method	TTL 256 split metering, multi metering
White balance	Auto
Flash	Auto flash / Forced flash/Suppressed flash Shooting range with flash: Approximately 50 cm to 1.5 m
Self-timer	Approximately 2 seconds / approximately 10 seconds
Image effects	6 filters, 10 frames (3 available with shortcuts)
Sound recording	Possible to record sound when shooting or playing back single image. Possible to overwrite.

### ■ Print Function

Film used	FUJIFILM instant film "INSTAX mini" (sold separately)
Number of films	10 films/pack
Film size	86 mm × 54 mm
Screen size	62 mm × 46 mm
Print pixel count	800 × 600 dots
Print resolution	12.5 dots / mm (318 dpi, 80 μm dot pitch)
Print gradation	RGB gradation of 256 colors
Printable image format	JPEG images taken with this unit

Print output time	Approximately 12 seconds
Print function	Images in the internal memory and images in the memory card can be printed
Reprint	Reprint is possible for images stored in Print history (up to 50)

### ■ Other

Smartphone app linked functions	Sound playback function from printed images, smartphone image print function, remote shooting function, frame selection function
LCD monitor	2.7-inch TFT color LCD monitor Pixel count: Approximately 230,000 dots
External interface	Micro USB Micro-B (for charging only)
Power supply	Lithium ion battery (internal type: not removable)
Charging function	Built-in battery
Possible number of printed images	Approximately 100 (from full charge) *The number of prints depends on the usage conditions.
Charging time	Approximately 2-3 hours *Charging time depends on the temperature.
Main unit dimensions	82.5 mm × 122.9 mm × 36.7 mm (excluding projecting parts)
Main unit weight	Approximately 255 g
Operating environment	Temperature: +5 °C to +40 °C Humidity: 20% to 80% (no condensation)

\*The above specifications are subject to change for performance improvement.

## Troubleshooting

Please check the following items before considering a problem to be a malfunction. If the problem persists even after taking action, please contact our service center for repair or visit the website below.

FUJIFILM website: <http://www.fujifilm.com/>

If the following problem occurs...

Problem	Possible causes and solutions
I cannot turn on the camera.	The battery may be exhausted. Please charge the camera.
The battery is exhausted quickly.	If you use the camera in a very cold environment, the battery will drain quickly. Please keep the camera warm before shooting.
Camera shuts down during use.	The battery level may be low. Please charge the camera.
Charging does not start.	<ul style="list-style-type: none"> <li>• Make sure that the USB power adapter plug is properly connected to the power outlet.</li> <li>• Turn off the camera when charging it. If power is on camera will not charge.</li> </ul>
It takes too long to charge.	At low temperatures, charging may take some time.
The self-timer lamp flashes while charging.	Charge the battery in a temperature range of +5 °C to +40 °C. If you cannot charge the battery within this range, please contact our support center.
I cannot shoot when I press the shutter button.	<ul style="list-style-type: none"> <li>• Make sure that the power is on.</li> <li>• If the battery level is low, please charge the camera.</li> <li>• If the internal memory or memory card is full, insert a new memory card or delete unnecessary images.</li> <li>• Use a memory card formatted with this unit.</li> <li>• If the contact surface of the memory card (gold part) is dirty, wipe it with a soft, dry cloth.</li> <li>• The memory card may be broken. Please insert a new memory card.</li> </ul>
I cannot focus the camera.	Use the AF/AE lock to shoot subjects that are difficult to focus on.
The flash does not fire.	Check that the suppressed flash setting has not been selected. Select a setting other than the suppressed flash setting.
Even though the flash fired, the image is dark.	<ul style="list-style-type: none"> <li>• Check that you are not too far from the subject. Please shoot within the flash range. Approximately 50 cm to 1.5 m.</li> <li>• Hold the camera correctly so that you do not obstruct the flash with your fingers.</li> </ul>

Problem	Possible causes and solutions
The image is blurred.	<ul style="list-style-type: none"> <li>• If the lens has dirt on it such as fingerprints, clean the lens.</li> <li>• Make sure that the AF frame is green before taking a photo.</li> </ul>
The camera does not work properly.	<ul style="list-style-type: none"> <li>• There may be a temporary malfunction. Please press the reset button. If it still does not work properly, please contact our repair service center for repair.</li> <li>• The battery may be exhausted. Please charge the camera.</li> </ul>
The film pack does not load or does not load smoothly.	<ul style="list-style-type: none"> <li>• Please use FUJIFILM instant film "INSTAX mini" (other films cannot be used).</li> <li>• Align the yellow mark on the film pack with the yellow alignment mark on the camera body to load the film.</li> </ul>
The film does not unload.	<ul style="list-style-type: none"> <li>• The film may be misaligned due to shocks such as vibration or dropping. Please load a new film pack.</li> <li>• If the film is jammed, turn off the camera and turn it on again. If the problem persists, remove the jammed film and then load a new film pack.</li> </ul>
Some or all of the finished prints are white.	Do not open the film door until all film exposures have been used. Unexposed film will be prematurely exposed if the door is opened. Prematurely exposed film will be white with no images.
The print is uneven.	<ul style="list-style-type: none"> <li>• Do not shake, bend, fold or hold the print immediately after it is printed.</li> <li>• Do not obstruct the film ejection slot.</li> </ul>

## IMPORTANT SAFETY NOTICE

This product has been designed with safety in mind and to also provide safe service when handled correctly in accordance with the User's Guide and the instructions provided. It is important that both the product and the "INSTAX mini" film are handled properly and used only to print photos as instructed in the User's Guide and in the "INSTAX mini" film instructions. For your ease and safety, please follow what is written in the User's Guide. It is also a good idea to keep the User's Guide in a safe, easy to find place where you can refer to it if needed.

### WARNING

This symbol indicates danger, which could result in injury or death. Please follow these instructions.

### WARNING

 If one of the following cases occur, immediately unplug the USB cable, turn the camera off and refrain from using the camera.

- The camera becomes hot, emits smoke, has a burnt smell, or otherwise seems abnormal.
- The camera is dropped into water, or foreign objects like water or metal get inside the camera.

 As the battery is built inside the camera, do not subject it to heat, throw it into an open fire, attempt to drop it, or apply impact to it. Doing so could cause the camera to explode.

### WARNING

 Never attempt to take this product apart. You may be injured.

 If anything is wrong with the camera, never attempt to repair it by yourself. You may be injured.

 If this product is dropped or damaged so that the inside is showing, do not touch it. Contact your FUJIFILM dealer.

 Do not touch any parts or projecting parts inside the back cover. You may be injured.

 Never get this product wet or handle it with wet hands. Doing so may result in an electric shock.

 Promptly unplug the USB cable once battery is fully charged.

 Keep out of the reach of small children. This product could cause injury in the hands of a child.

 Do not cover or wrap the camera or the AC power adapter in a cloth or blanket. This can cause heat to build up and distort the casing or cause a fire.



The "CE" mark certifies that this product satisfies the requirements of the EU (European Union) regarding safety, public health, environment and consumer protection. ("CE" is the abbreviation of Conformité Européenne.)

Hereby, FUJIFILM declares that the radio equipment type "INSTAX mini HM1" is in compliance with Directive 2014/53/EU.

For more information, access the website below.

[http://www.fujifilm.com/products/instant\\_photo/cameras/instax\\_mini\\_liploy/](http://www.fujifilm.com/products/instant_photo/cameras/instax_mini_liploy/)

## Simple Camera Care

### ■ Camera Care

1. Do not open the film door until you have used up the film; otherwise, the rest of the film is exposed and turns white and the film can no longer be used.
2. Your camera is a fragile object. Do not expose it to water, sand or gritty materials and do not drop.
3. Do not use a strap made for cellular phones or other similar electronic products. These straps are usually too weak to hold your camera securely. For safety, only use straps designed for your camera, and use only as specifically intended and instructed.
4. Do not use solvent such as thinner or alcohol to remove dirt.
5. Do not leave your camera in direct sun, or hot places such as a car. Do not leave it in damp places for long periods.
6. Moth repellent gas such as naphthalene may affect your camera and prints. Be careful to keep your camera and prints in a safe, dry place.
7. Note that the temperature range within which your camera can be used is +5 °C to +40 °C.
8. Take great care to ensure that printed materials do not violate copyright, image rights, privacy or other personal rights and do not offend public decency. Actions that violate the rights of others, are contrary to public decency or constitute a nuisance may be punishable by law or otherwise legally actionable.

### ■ Handling the LCD Monitor

As the LCD monitor can be easily scratched or damaged by sharp or solid objects, we recommend you attach a protective sheet (commercially available) onto the monitor.

### ■ Charging the Battery

The battery is not charged at shipment. Charge the battery completely before use.

Charge the battery using the supplied USB cable. Charging times will increase at ambient temperatures below +10 °C or above +35 °C. Do not attempt to charge the battery at temperatures above +40 °C or at temperatures below +5 °C as the battery will not charge.

### ■ Battery Life

At normal temperatures, the battery can be recharged about 300 times. A noticeable decrease in the length of time the battery will hold a charge indicates that it has reached the end of its service life.

### ■ Cautions: Handling the Battery

The battery and camera body may become warm to the touch after extended use. This is normal.

### ■ Certification marks acquired by the camera are located inside the film chamber.

### ■ Cautions During Printing



Do not shake the camera while printing.

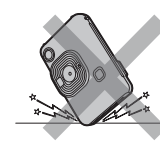

Do not drop the camera while printing.



Do not cover the film ejection slot while printing.

### ■ “INSTAX mini” Film and Print Care

See FUJIFILM Instant Film “INSTAX mini” for film use instructions. Follow all instructions for safe and proper use.

1. Keep the film in a cool place. Do not leave the film in a place where the temperature is extremely high (e.g., in a closed car) for many hours.
2. Do not puncture, tear, or cut “INSTAX mini” film. If film becomes damaged, do not use.
3. When you load a film pack, use the film as soon as possible.
4. If the film has been kept in a place where the temperature is extremely high or low, bring it to room temperature before starting to print photos.
5. Be sure to use the film before the expiration or “Use Before” date.
6. Avoid airport checked luggage inspection and other strong X-ray illumination. The effect of fogging, etc. may appear on unused film. We recommend that you carry the camera and/or the film onto the aircraft as carry-on luggage. (Check with each airport for more information.)
7. Avoid strong light, and keep the developed prints in a cool and dry place.
8. Do not puncture or cut this film as it contains a small amount of caustic paste (high alkaline). Never let children or animals put the film into their mouth. Also pay attention so that the paste does not come into contact with skin or clothes.
9. In case the paste inside the film comes into contact with skin or clothes, immediately wash off with plenty of water. If the paste comes into contact with the eyes or mouth, immediately wash the area with plenty of water and contact a doctor. Note that the alkaline inside the film remains active for about 10 minutes after the photo has been printed.

### ■ Cautions on Handling the Film and Prints

For details, refer to the instructions and warnings on FUJIFILM Instant Film “INSTAX mini”.



### Bluetooth® Devices: Cautions

**IMPORTANT:** Read the following notices before using the product's built-in Bluetooth transmitter.

#### ■ Use only as part of a Bluetooth network.

FUJIFILM does not accept liability for damages resulting from unauthorized use. Do not use in applications requiring a high degree of reliability, for example in medical devices or other systems that may directly or indirectly impact human life. When using the device in computer and other systems that demand a greater degree of reliability than Bluetooth networks, be sure to take all necessary precautions to ensure safety and prevent malfunction.

#### ■ Use only in the country in which the device was purchased.

This device conforms to regulations governing Bluetooth devices in the country in which it was purchased. Observe all location regulations when using the device. FUJIFILM does not accept liability for problems arising from use in other jurisdictions.

#### ■ Wireless data (images) may be intercepted by third parties.

The security of data transmitted over wireless networks is not guaranteed.

#### ■ Do not use the device in locations subject to magnetic fields, static electricity, or radio interference.

Do not use the transmitter in the vicinity of microwave ovens or in other locations subject to magnetic fields, static electricity, or radio interference that may prevent reception of wireless signals. Mutual interference may occur when the transmitter is used in the vicinity of other wireless devices operating in the 2.4 GHz band.

#### ■ The Bluetooth transmitter operates in the 2.4 GHz band. The standard output is 3.16 mW.

#### ■ This device operates on the same frequency as commercial, educational, and medical devices and wireless transmitters.

It also operates on the same frequency as licensed transmitters and special unlicensed low-voltage transmitters used in radio-frequency identification tracking systems for assembly lines and in other similar applications.

#### ■ To prevent interference with the above devices, observe the following precautions.

Confirm that the radio-frequency identification transmitter is not in operation before using this device. If you notice that this device causes interference in low-voltage radio-frequency identification tracing systems, contact a FUJIFILM representative.

#### ■ The following may be punishable by law:

- Disassembly or modification of this device.
- Removal of device certification labels.

#### ■ Trademark Information

The Bluetooth® word mark and logos are registered trademarks owned by the Bluetooth SIG, Inc., and any use of such marks by FUJIFILM is under license.

**Information for traceability in Europe**

Manufacturer: FUJIFILM Corporation

Address, City: 7-3, Akasaka 9-Chome, Minato-ku, Tokyo

Country: JAPAN

Authorized representative in Europe:

FUJIFILM EUROPE GMBH

Address, City: Dusseldorf Heesenstrasse 31, 40549

Country: Germany

If you have any inquiries about this product, please contact a FUJIFILM authorized distributor, or access the website below.  
<http://www.fujifilm.com/>

# FUJIFILM

---

**FUJIFILM Corporation**

7-3, AKASAKA 9-CHOME, MINATO-KU, TOKYO 107-0052, JAPAN