

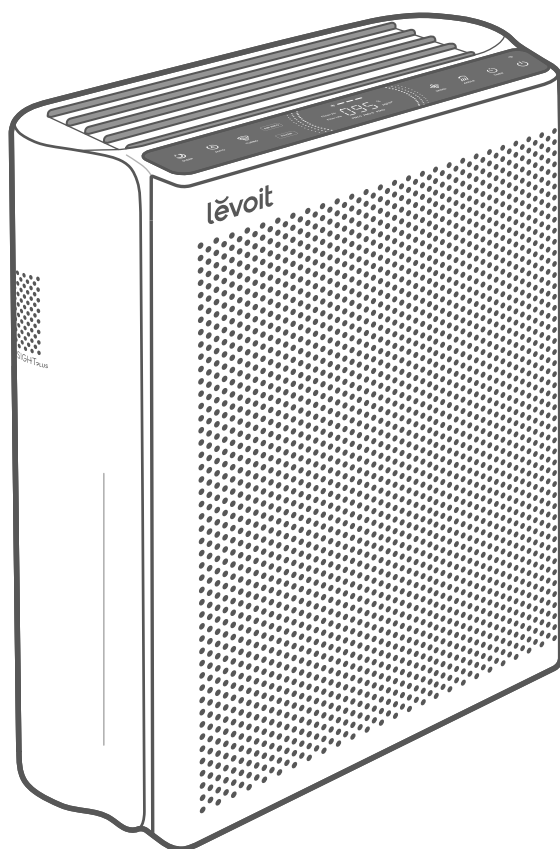

USER MANUAL

# EverestAir™ Smart True HEPA Air Purifier



## Questions or Concerns?

Please contact us Mon–Fri, 9:00 am–5:00 pm PST/PDT  
at [support@levoit.com](mailto:support@levoit.com) or at **(888) 726-8520**.

## Table of Contents

Package Contents	2
Specifications	2
Safety Information	3
Getting to Know Your Smart Air Purifier	5
Controls & Display	6
Getting Started	8
Using Your Smart Air Purifier	10
About the Filter	15
Care & Maintenance	17
Troubleshooting	20
Warranty Information	24
Customer Support	25

## Package Contents

- 1 x Smart Air Purifier
- 1 x True HEPA 3-Stage Original Filter (Pre-Installed)
- 1 x User Manual
- 1 x Quick Start Guide
- 1 x Power Cord

## Specifications

Model	LAP-EL551S-AUS LAP-EL551S-AUSR LAP-EL551S-WUSB
Power Supply	AC 120V, 60Hz
Rating	70W, 1A
Ideal Room Size	558 ft <sup>2</sup> / 52 m <sup>2</sup> <ul style="list-style-type: none"><li>This Ideal Room Size is based on 5 air changes per hour (ACH).</li></ul> 1,395 ft <sup>2</sup> / 130 m <sup>2</sup> <ul style="list-style-type: none"><li>This Ideal Room Size is based on 2 air changes per hour (ACH).</li></ul> <b>Note:</b> Effective for larger rooms but purification will take longer.
CADR (CFM)	360 CFM / 612 m <sup>3</sup> /h
Operating Conditions	<b>Temperature:</b> 14°–104°F / -10°–40°C
	<b>Humidity:</b> < 85% RH
Noise Level	24–56dB
Dimensions	18.9 x 8.5 x 23.2 in / 48 x 21.6 x 58.9 cm
Weight	20.7 lb / 9.38 kg

**Note:** To access additional smart functions, download the free VeSync app (see page 9).

# READ AND SAVE THESE INSTRUCTIONS

## SAFETY INFORMATION

To reduce the risk of fire, electric shock, or other injury, follow all instructions and safety guidelines.

### General Safety

- **Only** use your air purifier as described in this manual.
- **Do not** use without removing the plastic wrap from the filter. The air purifier will not filter air, and may overheat, causing a fire hazard.
- **Do not** use the air purifier outdoors.
- Keep the air purifier away from water, and wet or damp areas. **Never** place in water or liquid.
- **Do not** use in excessively humid areas.
- Keep the air purifier away from heat sources.
- **Do not** use where combustible gases, vapors, metallic dust, aerosol (spray) products, or fumes from industrial oil are present.
- Keep 5 ft / 1.5 m away from where oxygen is being administered.
- Children should be supervised to ensure that they **do not** play with the air purifier.
- **Do not** place anything into any opening in the air purifier.
- Children should be supervised to ensure that they **do not** insert fingers or objects into the vent openings while the vents are moving.
- **Do not** sit on or place heavy objects on the air purifier.
- Keep the inside of the air purifier dry. To prevent moisture buildup, avoid placing in rooms with major temperature changes.
- **Always** unplug the air purifier before servicing (such as changing the filter).
- **Do not** use the air purifier if it is damaged or not working correctly, or if the cord or plug is damaged. **Do not** try to repair it yourself. Contact **Customer Support** (see page 25).
- **WARNING:** To reduce the risk of fire or electric shock, **do not** use this air purifier with any solid-state speed controls (such as a dimmer switch).
- Children should not clean or perform maintenance on the air purifier without supervision.
- This air purifier is not to be used by persons (including children) with reduced physical, sensory, or mental capacities, or lack of experience and knowledge, unless they have been given supervision or instruction concerning the use of the appliance by a person responsible for the safety.
- Not for commercial use. Household use **only**.

### Power & Cord

- Keep the air purifier near the outlet it is plugged into.
- **Never** place the cord near any heat source.
- **Do not** cover the cord with a rug, carpet, or other covering. **Do not** place the cord under furniture or appliances.
- Keep the cord out of areas where people walk often. Place the cord where it will not be tripped over.

## SAFETY INFORMATION (CONT.)

- This appliance has a polarized plug (one blade is wider than the other). To reduce the risk of electric shock, this plug is intended to fit in a polarized outlet only one way. If the plug does not fit fully in the outlet, reverse the plug. If it still does not fit, contact a qualified electrician. **Do not** attempt to defeat this safety feature.
- This air purifier uses standard North American 120V, 60Hz outlets. If using outside the US or Canada, check for compatibility.
- If the power supply cord is damaged, it must be replaced by Arovast Corporation or similarly qualified persons in order to avoid an electric or fire hazard. Please contact **Customer Support** (page 25).
- Unplugging the power cord will disable remote control of the air purifier and temporarily disconnect the air purifier from VeSync and other third-party apps.

### Electromagnetic Fields (EMF)

Your Levoit air purifier complies with all standards regarding electromagnetic fields (EMF). If handled properly and according to the instructions in this user manual, the appliance is safe to use based on scientific evidence available today.

# GETTING TO KNOW YOUR SMART AIR PURIFIER

- A.** Sleep Mode Button
- B.** Auto Mode Button
- C.** Turbo Mode Button
- D.** Air Info Button
- E.** Air Quality Indicator Rings
- F.** Clean Air Indicator
- G.** Fan Speed Indicators
- H.** Fan Speed Button
- I.** Vent Angle Button
- J.** Timer Button
- K.** Wi-Fi® Indicator
- L.** On/Off Button
- M.** Filter Info Button / Check Filter Indicator
- N.** Filter Life Indicator
- O.** Particulate Matter (PM) Indicators
- P.** Light Sensor
- Q.** AirSight Plus™ 2.0 Laser Dust Sensor
- R.** Vents
- S.** Display
- T.** True HEPA / Activated Carbon Filter
- U.** Washable Pre-Filter
- V.** Front Cover
- W.** Power Cord
- X.** Wheels (Underneath)

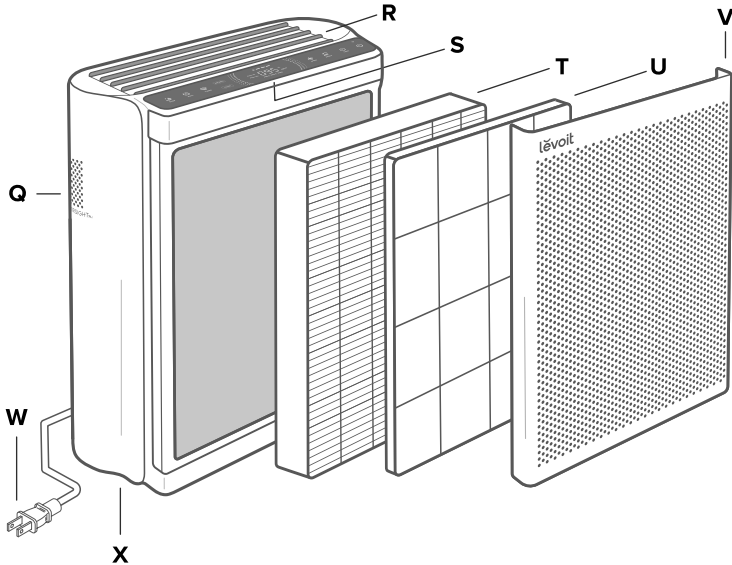
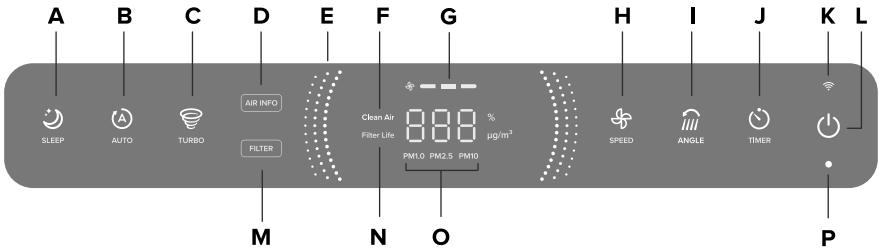

# CONTROLS & DISPLAY

- **Note:** You can also use the VeSync app to control these functions, as well as additional app-only features (see page 9).



## On/Off Button

- Turns the air purifier on/off.
- Press and hold for 5 seconds to connect the air purifier to the VeSync app. See the in-app instructions for more information.
- Press and hold for 15 seconds to reset the air purifier and disconnect from Wi-Fi (see page 9).



## Display

- Shows information related to air quality and air purifier settings.
- By default, the display will show the overall clean air percentage.
- The display will reset to default when the air purifier is turned on/off.



## Sleep Mode Button

- Turns Sleep Mode on/off (see page 10).



## Auto Mode Button

- Turns Auto Mode on/off (see page 10).



## Turbo Mode Button

- Turns Turbo Mode on/off (see page 10).

AIR INFO

## Air Info Button

- Changes the type of air quality information shown on the center of the display.
- Cycles through air quality readings for PM1.0, PM2.5, PM10, and overall clean air percentage (see **Air Information**, page 11).
- The chosen air quality information will stay on the display until you restart the air purifier.

FILTER

## Filter Info Button

- Shows the filter life percentage on the center of the display. After a few moments, the display will return to its previous setting.
- Button lights up when the filter should be checked (see **Check Filter Indicator**, page 17).
- Press and hold for 3 seconds to reset the indicator (see page 17).



## Air Quality Indicator Rings

- These indicators use an automatic sensor to display the air quality: Blue (Very Good), Green (Good), Orange (Moderate), and Red (Bad).

## CONTROLS & DISPLAY (CONT.)



### Fan Speed Button

- Cycles through fan speeds: low (1 indicator will light up), medium (2 indicators), and high (3 indicators).
- Tapping the Fan Speed Button while the air purifier is in Auto Mode, Turbo Mode, or Sleep Mode (if the display is on) will exit that mode.



### Vent Angle Button

- Cycles through vent angles: 45°, 60°, 75°, and 90° (see page 12).



### Timer Button

- Cycles through timer options from 1–12 hours (see page 12).
- Press and hold ⏸ for 2 seconds to begin cycling through the timer options in 1-hour increments.



### Wi-Fi® Indicator

- Turns on, off, or blinks to indicate pairing status. See the VeSync in-app instructions for more information.



### Light Sensor

- This sensor detects the amount of light in the room to automatically adjust air purifier settings (see **Light Detection**, page 14).
- Light Detection can be turned on/off in the VeSync app (see page 14).

# GETTING STARTED

1. Place the air purifier on a flat, stable surface such as the floor. Pull the front cover to remove it. Pull the tabs to remove the pre-filter from the air purifier. [Figure 1.1]

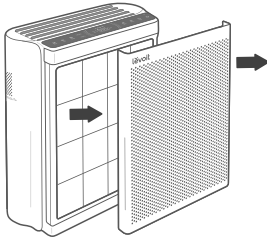

Figure 1.1

2. Remove the True HEPA / activated carbon filter from inside the air purifier. Remove the plastic packaging from the filter and place the filter and pre-filter back into the air purifier. [Figure 1.2]

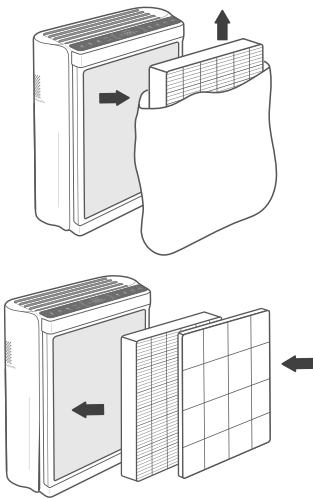

Figure 1.2

**Note:** Make sure the True HEPA filter (the side with the ribbon handle) is facing outward when you insert the filter.

3. Place the front cover back on the air purifier. Make sure to align the tabs on the cover with the slots on the bottom of the air purifier. [Figure 1.3]

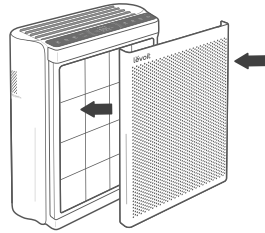

Figure 1.3

**Note:** The front cover attaches to the air purifier with magnets.

4. Insert the power cord into the back of the air purifier.
5. When using the air purifier, allow at least 15 inches / 38 cm of clearance from the front of the air purifier. Keep away from anything that would block airflow, such as curtains. [Figure 1.4]

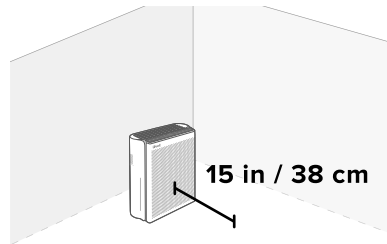

Figure 1.4

## VeSync App Setup

**Note:** The VeSync app is continually being improved and may change over time. If there are any differences, follow the in-app instructions.

1. To download the VeSync app, scan the QR code or search “VeSync” in the Apple App Store® or Google Play Store.



**Note:** For Android™ users, choose “Allow” to use VeSync.

2. Open the VeSync app. **Log In** or **Sign Up**.

**Note:** You must create your own VeSync account to use third-party services and products. These will not work with a guest account. With a VeSync account, you can also allow your family and friends to control your smart air purifier.

3. Follow the in-app instructions to set up your smart air purifier.

**Note:** Your phone must have Location turned on while your phone is connecting to your smart air purifier. This is required to establish the Bluetooth® connection. You can turn Location off after your smart air purifier is finished connecting to the VeSync app.

## Wi-Fi Connection

- To disconnect Wi-Fi, press and hold  for 15 seconds until the Wi-Fi indicator turns off. This will restore the smart air purifier's default settings and disconnect it from the VeSync app.
- To reconnect, please follow the instructions in the VeSync app for adding a device.



## Connect with Amazon Alexa or Google Assistant™

You can use the VeSync app to connect your smart air purifier to **Amazon Alexa** or **Google Assistant™**. Please follow the in-app instructions to set up your voice assistant.

**Note:** You must create your own VeSync account to access voice assistants.

# USING YOUR SMART AIR PURIFIER

**Note:** Using the VeSync app allows you to control your air purifier remotely and access additional functions and features (see page 14).

1. Plug in and tap  to turn on the air purifier. [Figure 2.1]
2. Tap  to change fan speed between low, medium, and high.

**Note:**

- The fan speed indicators will light up when active. 1 indicator will light up for low, 2 for medium, and 3 for high.
- For best results, or to address a specific air quality issue such as smoke, press  to run the air purifier on Turbo Mode turbo for 15–20 minutes before using a lower speed.
- To effectively clean air, keep windows and doors closed while the air purifier is on.

3. Tap  to turn off the air purifier.

## Sleep Mode

Sleep Mode operates quietly by using a fan speed lower than low speed.

1. Tap  to turn Sleep Mode on/off.
2. Sleep Mode will turn off the display after 6 seconds if no other buttons are tapped.

**Note:**

- When the display is turned off, tap any button to turn the display back on. If you don't tap another button, the display will turn off again after 6 seconds.
-  will still turn on and stay on if it's time to check your filter (see page 17)

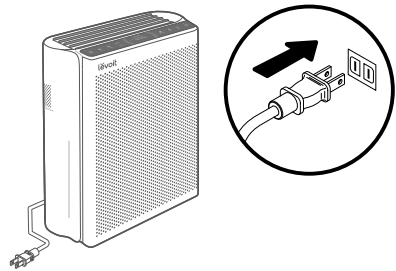



Figure 2.1

## Turbo Mode

Turbo Mode cleans your air very quickly by using a fan speed higher than high speed.



1. Tap  to turn Turbo Mode on/off.
2.  will light up while Turbo Mode is turned on.

**Note:**

- Turbo Mode is the loudest air purifier mode, but cleans air the quickest.
- You can run the air purifier in Turbo Mode for 15–20 minutes to increase air purification speed, or for specific situations like heavy odors or visible smoke. For serious air quality issues, try running the air purifier in Turbo Mode for longer.

## Auto Mode

Auto Mode uses AirSight Plus™ 2.0, a smart laser dust sensor inside the air purifier, to adjust the fan speed automatically based on air quality. For example, if the air quality is bad, the fan will automatically be set to high speed.

1. Tap  to turn Auto Mode on/off.
2.  will light up while Auto Mode is on.

## USING YOUR SMART AIR PURIFIER (CONT.)

Air Quality Indicator Chart			
Indicator Color	Clean Air Percentage Range	Air Quality	Auto Mode Fan Speed
Blue	90–100%	Very Good	Sleep Mode
Green	80–89%	Good	Low
Orange	70–79%	Moderate	Medium
Red	0–69%	Bad	High

### Note:

- The air purifier will take 5 seconds to detect the air quality each time it is turned on. During this time, the air quality indicator rings will be blue. After 5 seconds, the air quality indicator rings will change color based on the detected air quality.
- Auto Mode does not use the Turbo Mode.
- The VeSync app also supports ECO Auto Mode (see page 14).

## Air Information

Your air purifier automatically scans your air and analyzes the quality. By default, the air purifier shows the overall clean air percentage on the center of the display.

1. Tap **AIR INFO** to change the air quality information shown on the center of the display.
2. Keep tapping **AIR INFO** to cycle through air quality readings for PM1.0, PM2.5, PM10, and overall clean air percentage. For more information, see **PM Values** (page 11).
3. When you stop tapping **AIR INFO**, the current air quality reading will stay on the display until you restart the air purifier. If you restart the air purifier, the display will again show the overall clean air percentage.

## Clean Air Percentage

Clean air percentage is an estimated measurement of the amount of clean air in the room, between 0% (bad) to 100% (very good).

This percentage is calculated by an algorithm, based on:

- The concentration of particles detected in the air, including micro-particles.
- The change in detected particles in the air during purification.

**Note:** The percentage is approximate. The sensor can only detect airborne particles, not odors or gasses.

## PM Values

“PM” stands for “Particulate Matter,” and usually refers to airborne particles floating in your air, including dust and most allergens. Many of these particles are too small to be seen with the naked eye, and without air purification, they stay in the air much longer than heavier or larger particles.

Your air purifier’s AirSight Plus 2.0 Laser Dust Sensor detects the amount of airborne particles that are in a given space ( $\mu\text{g}/\text{m}^3$ ). Generally, the lower the number, the better your air quality.

## USING YOUR SMART AIR PURIFIER (CONT.)

When you press  to show PM readings on the display, the number is the estimated amount of airborne particles ( $\mu\text{g}$ ) that are detected per 1 cubic meter ( $\text{m}^3$ ) of air volume.

The PM value (1.0, 2.5, or 10) refers to particulate matter (PM) less than or equal to 1, 2.5, or 10 microns ( $\mu\text{m}$ ) in size (measured by the diameter of the particle). For example, PM2.5 refers to particulate matter that is 2.5 microns or smaller.

Particulate Matter (PM)	Size	Examples
PM1.0	$\leq 1 \mu\text{m}$	Fine dust, micro-toxins
PM2.5	$\leq 2.5 \mu\text{m}$	Dust, smoke, pet dander
PM10	$\leq 10 \mu\text{m}$	Pollen, ash, airborne allergens

## Vent Angle

You can set the vents on top of the air purifier to different angles to disperse purified air throughout your room more efficiently.

Purified air is typically dispersed in a fixed direction through the top of the air purifier. Having different vent angles is especially effective in rooms with a lot of furniture or other objects that can block airflow, as well as rooms with an unusual layout or high ceilings.

1. By default, the vents disperse air at a fixed 75° angle.
2. Press  to rotate the vents to a different angle. The vents will cycle through 45°, 60°, 75°, and 90° angles.

**Note:** If the vents start at a 75° angle, press  to change the vent angle to 90°. Press the button repeatedly to rotate the vents down to 75°, 60°, and 45°.

3.  lights up when the vents are rotating and turns off when the vents reach the desired angle.

### Note:

- **Do not unplug the air purifier while it is running.** Tap  to turn off the air purifier, then unplug.
- The vents will not close if power is unexpectedly cut off.
- The angle of the vents can be adjusted to any angle between 45°–90° in the VeSync app.

## Light Detection

Light Detection uses the built-in light sensor to automatically adjust air purifier settings based on the amount of light in the room.

- The display will automatically turn off when the room gets dark. If the air purifier is in Auto Mode, it will not use the high fan speed or Turbo Mode, even when the air quality is poor, to avoid making too much noise.
- When the room becomes light again, the air purifier will return to its previous settings. The display will automatically turn back on, and Auto Mode will no longer be limited.

**Note:** Light Detection can be turned on/off in the VeSync app (see page 14).





## Timer

You can set a timer for 1–12 hours.

**Note:** You can set a timer for 1–24 hours in the VeSync app.

1. Tap  repeatedly to set a timer in 1-hour increments, beginning with 1 hour. If you don't touch any buttons for 5 seconds, the display will switch to showing the air quality reading and the timer will start automatically.

## USING YOUR SMART AIR PURIFIER (CONT.)

- To cycle through timer options more quickly, press and hold  for 2 seconds.
- 2.** The timer will count down from your selected time.
    - You can change the fan speed at any time while the timer is on.
  - 3.** While the timer is on, you can tap  to show the remaining time (rounded up to the nearest hour) for 5 seconds. Within these 5 seconds, you can tap  again to add more time in 1-hour increments.
    - The timer will restart if the time is changed.
    - You can see the exact remaining time in the VeSync app.
  - 4.** When the timer is finished, the air purifier will turn off.
  - 5.** To cancel a timer, tap  repeatedly until the display reads "--H".

**Note:** The air purifier will remember the last timer setting while turned off. When you restart the air purifier, you'll also need to restart the timer.

## Standby Mode

The air purifier is in Standby Mode when it is turned off, but plugged in.

**Note:**

- In Standby Mode, the laser dust sensor will still detect the surrounding air quality and give you updates in the VeSync app.
- Display Lock (available in the VeSync app) can be used while the air purifier is in Standby Mode to keep the air purifier from being turned back on.

## Memory Function

When the air purifier is plugged in and turned off, it will remember its previous fan speed, vent angle setting, Sleep Mode, Auto Mode, and Turbo Mode. It will also remember the in-app settings for Display Off and Light Detection.

When the air purifier is unplugged and turned off, it will only remember its previous fan speed, Sleep Mode, Auto Mode, Turbo Mode, and in-app Light Detection settings.

**Note:** The air purifier will remember the last timer setting while turned off, but will not automatically resume the timer. When you restart the air purifier, you'll also need to restart the timer.

## USING YOUR SMART AIR PURIFIER (CONT.)

### VeSync App Functions

The VeSync app allows you to access additional smart air purifier functions, including those listed below. As the app develops, more features may become available.

#### Remote Control

- Change any air purifier settings through the app, even while Display Lock is on.

#### Air Quality Updates

- View real-time air quality updates in the app, including PM1.0, PM2.5, and PM10 information.
- See your air quality history for the previous week.

#### Light Detection

- Turn Light Detection on/off (see page 12).

#### Auto Modes

- Select default Auto Mode or ECO Auto Mode.
- ECO Auto Mode allows the fan speed to turn on/off intermittently when air quality is Very Good, to save electricity. When air quality is poor, the fan speed will be increased like standard Auto Mode.

#### Vent Rotation Angle

- Set the vents to any angle between 45°–90°.

#### Display Lock

- Turn the Display Lock on/off.
- Display Lock prevents current settings from being changed on the air purifier.
-  will flash to indicate that the display is locked.

#### Schedules

- Create and customize schedules for your air purifier to match your routines.

#### Timer Function

- Set a timer for up to 24 hours (instead of up to 12).
- Easily view the exact time remaining on a timer.

#### Filter Replacement Info

- Keep tabs on the remaining filter life by checking the filter life percentage in the app.
- Shop for replacement filters.

# ABOUT THE FILTER

The air purifier uses a 3-stage filtration system to purify air.

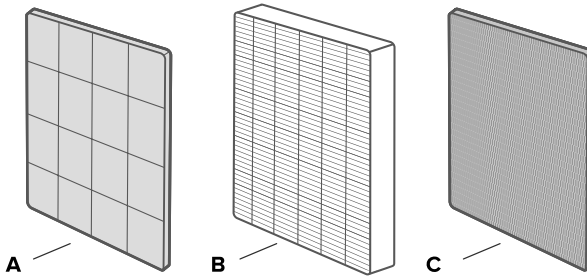

## A. Washable Pre-Filter

- Captures large particles such as dust, lint, fibers, hair, and pet fur.
- Maximizes the filter's life by protecting it.
- Removable and washable to increase filtering efficiency (see **Cleaning the Pre-Filter**, page 17).

## B. H13 True HEPA Filter

- Captures at least 99.97% of airborne particles 0.3 microns ( $\mu\text{m}$ ) in size.
- Traps small particles such as fine dust, smoke particles, and allergens such as pollen and pet dander.

## C. High-Efficiency Activated Carbon Filter

- Physically adsorbs smoke, odors, and fumes.
- Filters compounds such as formaldehyde, benzene, ammonia, and hydrogen sulfide.
- Reduces household odors from food, cigarettes, and pets.
- Tested to effectively filter volatile organic compounds (VOCs).

**Note:** Carbon filter efficiencies decrease with use. If your air purifier isn't as effective at filtering odors or gasses, make sure to replace the filter (see page 19).

## COVID-19 Disclaimer

According to the CDC, portable HEPA filtration units that combine a HEPA filter with a powered fan system are effective at cleaning air within spaces to reduce the concentration of airborne particulates, including SARS-CoV-2 (COVID-19) viral particles.

### Sources:

<https://www.cdc.gov/coronavirus/2019-ncov/community/ventilation.html#refphf>  
<https://www.cdc.gov/mmwr/volumes/70/wr/mm7027e1.htm>

**Note:** Levoit has not tested its air purifiers for effectiveness against SARS-CoV-2 and makes no claims that these air purifiers help reduce the spread of COVID-19.

## ABOUT THE FILTER (CONT.)

### Clean Air Delivery Rate

This air purifier has a Clean Air Delivery Rate of 360 cubic feet per minute (CFM), or 612 m<sup>3</sup>/h.

Clean Air Delivery Rate (CADR) measures the efficiency of an air purifier by indicating the volume of clean air that an air purifier produces per minute. This is based on removal of dust, pollen, and smoke, which are the 3 most common indoor air pollutants. The higher the CADR, the more particles the air purifier will remove and the larger the area it can clean. The rating is measured at the air purifier's highest speed.

### Air Change Per Hour

The air change rate is how many times all of the air in a room can be purified (or "changed") by the air purifier in 1 hour. Air changes per hour (ACH) are calculated with the recommended room size assuming 8 ft / 2.4 m ceilings. For smaller rooms, the air change per hour will increase. This air purifier can change air 5 times per hour at the max speed in a single, closed room up to 558 ft<sup>2</sup> / 52 m<sup>2</sup>. This is measured at ACH 5. The air purifier is effective for larger rooms, but air purification will take longer, with fewer air changes per hour. For example, the air purifier's effective range is 1,395 ft<sup>2</sup> / 130 m<sup>2</sup> based on 2 ACH, or purifying the air in the room 2 times per hour.

**Note:** To effectively clean air, keep windows and doors closed while the air purifier is on.

### Humidity

Moisture may damage the filter. This air purifier should be used in an area with a humidity level below 85% RH. If you use the air purifier in excessively humid areas, the surface of the filter may become moldy.

**Note:** Water or moisture will allow mold to grow. To solve a mold problem, get rid of the source of the moisture and clean up the mold.

### Essential Oils



**Do not** add essential oils to the air purifier or filter. The filter will become damaged by the oil and will eventually release an unpleasant smell. **Do not** use diffusers near the air purifier.

# CARE & MAINTENANCE

## Cleaning the Smart Air Purifier

- Unplug before cleaning.
- Wipe the outside of the air purifier with a soft, dry cloth. If necessary, wipe the housing with a damp cloth, then immediately dry.
- Vacuum the inside of the air purifier.
- **Do not** clean with abrasive chemicals or flammable cleaning agents.

## Check Filter Indicator

The Filter Button (  ) will light up as a reminder to check the filter. Depending on how often you use the air purifier, the indicator should turn on after about 12–15 months. You may not need to change your filter yet, but you should check it when  lights up.

When your air purifier is set up with the VeSync app, you can also check the app to see your remaining filter life. You will also receive a notification from VeSync when it's time to check your filter.

The VeSync app uses a scientific algorithm to determine your filter life based on air quality, amount of use, and other factors. The filter life percentage is based on 12 hours of daily use.



## Resetting the Check Filter Indicator

Reset the Check Filter Indicator when:

- A.  lights up. This is the Check Filter Indicator light.**
  1. Replace the filter (see page 19).
  2. Turn on the air purifier.

3. To reset the indicator light, press and hold  button for 3 seconds.
4. The indicator light will turn off when successfully reset and the filter life will show 100%.

### **B. The filter was changed before lit up.**

1. Press and hold the  button for 3 seconds.
2. The  will flash for 3 seconds.
3.  will stop flashing and turn off when successfully reset. The filter life will show 100%.

## Cleaning the Pre-Filter

The pre-filter should be cleaned every 2–4 weeks to increase efficiency and extend the life of your filter. Clean the pre-filter using a soft brush or vacuum hose to remove hair, dust, and large particles. Optionally, you can wash the pre-filter with water to remove dirt and dust.

*Note: Avoid scrubbing, scraping, or vigorously brushing the pre-filter. Do not use abrasive cleaning materials.*

1. Open the front cover and pull the pre-filter out to remove it.
2. Clean the surface of the pre-filter with a vacuum. *[Figure 3.1]*

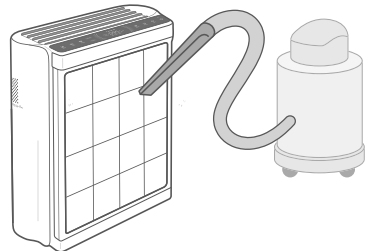
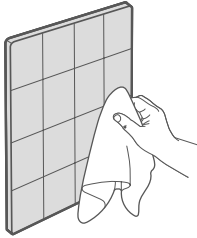

Figure 3.1

**CARE & MAINTENANCE (CONT.)**

- 3.** Rinse the pre-filter with water under a faucet.
- 4.** Wash the pre-filter with mild detergent and a soft cloth. *[Figure 3.2]*



*Figure 3.2*

- 5.** Allow the pre-filter to air-dry. Once completely dry, place the pre-filter back into the air purifier. *[Figure 3.3]*

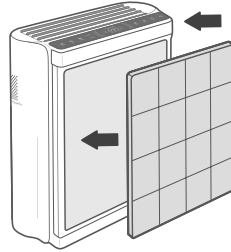

*Figure 3.3*

Filter	When to Clean	How to Clean	When to Replace
<b>Washable Pre-Filter</b>	Every 2–4 weeks	Use a soft cloth or vacuum hose	Does not need to be replaced
		Wash with water and mild detergent	
<b>True HEPA / Activated Carbon Filter</b>	<b>Do not</b> clean		12–15 months

## CARE & MAINTENANCE (CONT.)

### When Should I Replace the Filter?

The True HEPA / Activated Carbon Filter should be replaced every 12–15 months. You may need to replace your filter earlier or later depending on how often you use your air purifier. Using your air purifier in an environment with relatively high pollution may mean you will need to replace the filter more often, even if **FILTER** is off.

You may need to replace your filter if you notice:

- The air purifier does not effectively filter certain odors anymore
- Increased noise when the air purifier is on
- Decreased airflow from the top of the air purifier
- Unusual odors
- The HEPA filter is visibly dusty or discolored after removing the pre-filter

#### Note:

- To maintain the performance of your air purifier, only use official Levoit filters. For more information, contact **Customer Support** (see page 25).
- Remember to reset the **FILTER** indicator light after changing the filter (see page 17).

### Replacing the Filter

1. Unplug the air purifier, then pull the front cover to remove it (see **Getting Started**, page 8).
2. Remove the old filter from the air purifier.
3. Clean out any remaining dust or hair inside the air purifier using a vacuum hose.

**Note:** Do not use water or liquids to clean the air purifier. [Figure 3.5]

4. Remove the plastic packaging from the new filter and place the filter inside the air purifier. (see **Getting Started**, page 8).
5. Replace the front cover.
6. Plug in and turn on the air purifier. Reset the Check Filter Indicator (see page 17).

### Cleaning the AirSight Plus 2.0 Laser Dust Sensor

The AirSight Plus 2.0 Laser Dust Sensor can be blocked by dust, which affects the sensor's accuracy.

Clean the sensor every 3 months. Using your air purifier in an environment with more dust may mean you will need to clean the sensor more often.

1. Unplug the air purifier.
2. Place the end of a vacuum cleaner over the sensor openings. [Figure 3.6]
3. Turn the vacuum on for at least 10 seconds to clean out dust.

### Storage

If not using the air purifier for an extended period of time, wrap both the air purifier and the filter in plastic packaging and store in a dry place to avoid moisture damage.

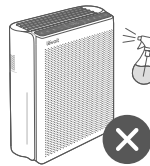

Figure 3.5

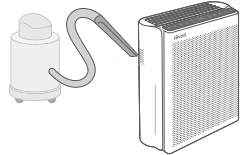





Figure 3.6

# TROUBLESHOOTING

<b>Problem</b>	<b>Possible Solution</b>
Air purifier will not turn on or respond to button controls.	Plug in the air purifier.
	Check to see if the power cord is damaged. If it is, stop using the air purifier and contact <b>Customer Support</b> (see page 25).
	Plug the air purifier into a different outlet.
	The air purifier may be malfunctioning. Contact <b>Customer Support</b> (see page 25).
Airflow is significantly reduced.	Make sure the filter is removed from its packaging and properly in place (see page 8).
	Tap  to increase the fan speed.
	Leave 15 inches / 38 cm of clearance from the front of the air purifier.
	The pre-filter may be clogged by large particles, such as hair or lint, blocking airflow. Clean the pre-filter (see page 17).
	Replace the filter (see page 19).
Air purifier makes an unusual noise while the fan is on.	Make sure the filter is properly in place with plastic packaging removed (see page 8).
	Make sure the air purifier is operating on a hard, flat, level surface.
	Replace the filter (see page 19).
	The air purifier may be damaged, or a foreign object may be inside. Stop using the air purifier and contact <b>Customer Support</b> (see page 25). <b>Do not</b> try to repair the air purifier.
Poor air purification quality.	Tap  or  to increase the fan speed.
	Make sure no objects are blocking the front or top of the air purifier (the inlet or outlet).
	Make sure the filter is removed from its packaging and properly in place (see page 8).
	Close doors and windows while using the air purifier.
	If the room is larger than 558 ft <sup>2</sup> / 52 m <sup>2</sup> , air purification will take longer.

**TROUBLESHOOTING (CONT.)**

<b>Problem</b>	<b>Possible Solution</b>
Strange smell coming from the air purifier.	Clean the filter, or replace if necessary.
	Contact <b>Customer Support</b> (see page 25).
	Make sure not to use your air purifier in an area with high humidity or while diffusing essential oils.
<b>FILTER</b> is still on after replacing the filter.	Reset the Check Filter Indicator (see page 17).
<b>FILTER</b> has not turned on after 12–15 months.	<b>FILTER</b> is a reminder for you to check the filter and will light up based on how much the air purifier has been used (see page 17). If you don't use your air purifier often, <b>FILTER</b> will take longer to turn on.
<b>FILTER</b> turned on before 12 months.	<b>FILTER</b> is a reminder for you to check the filter and will light up based on how much the air purifier has been used (see page 17). If you run your air purifier frequently, <b>FILTER</b> will turn on sooner.
Air Quality Indicator always stays red, and/or the PM value is always very high.	The AirSight Plus 2.0 Laser Dust Sensor may need to be cleaned (see page 16).
	If you're using an ultrasonic humidifier near the air purifier, the mist may affect the accuracy of the AirSight Plus 2.0 Laser Dust Sensor. The sensor will detect the large mist particles, and the Air Quality Indicator may turn red. Avoid using an ultrasonic humidifier near the air purifier, or avoid using Auto Mode.
Air Quality Indicator always stays blue, even when the air quality is poor.	The AirSight Plus 2.0 Laser Dust Sensor detects airborne particles, but it cannot detect gas. Make sure there isn't gas polluting the air.

**If your problem is not listed**, please contact **Customer Support** (see page 25).

# VESYNC APP TROUBLESHOOTING

## My smart air purifier isn't connecting to the VeSync app.

- Make sure your phone has Bluetooth® turned on and is not currently connected to another Bluetooth device.
- During the setup process, you must be on a secure 2.4GHz Wi-Fi® network. Confirm that the network is working correctly.
- Make sure the Wi-Fi password you entered is correct.
  - There should be no spaces at the beginning or end of the password.
  - Test the password by connecting a different electronic device to the router.
  - If you're manually typing in the SSID and password, double check that both are entered correctly.
- Try moving your air purifier closer to the router. Your phone should be as close as possible to your air purifier.
- Your router may need to be at a higher location, away from obstructions.
- Make sure your air purifier and router are away from appliances (such as microwave ovens, refrigerators, electronic devices, etc.) to avoid signal interference.
- If you're using a VPN, make sure it's turned off while setting up your air purifier.
- Disable portal authentication for your Wi-Fi network. If portal authentication is enabled, the air purifier will not be able to access your Wi-Fi network, and setup will fail.

**Note:** *Portal authentication means that you need to sign in to your Wi-Fi network through a web page before you can use the Internet.*

## My air purifier is offline.

- Make sure the air purifier is plugged in and has power, then refresh the VeSync menu by swiping down on the screen.
- Make sure your router is connected to the internet and your phone's network connection is working.
- Delete the offline air purifier from the VeSync app. Swipe left (iOS®) or press and hold (Android™), then tap **Delete**. Reconfigure the air purifier with the VeSync app.

**Note:** *Power outages, internet outages, or changing Wi-Fi routers may cause the air purifier to go offline.*

**If your problem is not listed,** please contact **Customer Support** (see page 25).

# FEDERAL COMMUNICATION COMMISSION INTERFERENCE STATEMENT – PART 15

This device complies with Part 15 of the FCC Rules. Operation is subject to the following two conditions:

1. This device may not cause harmful interference, and
2. This device must accept any interference received, including interference that may cause undesired operation.

NOTE: This equipment has been tested and found to comply with the limits for a Class B digital device, pursuant to Part 15 of the FCC Rules. These limits are designed to provide reasonable protection against harmful interference in a residential installation. This equipment generates, uses and can radiate radio frequency energy and, if not installed and used in accordance with the instructions, may cause harmful interference to radio communications. However, there is no guarantee that interference will not occur in a particular installation. If this equipment does cause harmful interference to radio or television reception, which can be determined by turning the equipment off and on, the user is encouraged to try to correct the interference by one or more of the following measures:

- Reorient or relocate the receiving antenna.
- Increase the separation between the equipment and receiver.
- Connect the equipment into an outlet on a circuit different from that to which the receiver is connected.
- Consult the dealer or an experienced radio/TV technician for help.

**FCC Caution:** Any changes or modifications not expressly approved by the party responsible for compliance could void the user's authority to operate this equipment.

## FCC RADIATION EXPOSURE STATEMENT

This equipment complies with FCC radiation exposure limits set forth for an uncontrolled environment. End users must follow the specific operating instructions for satisfying RF exposure compliance. To maintain compliance with FCC RF exposure compliance requirements, please follow operation instructions as documented in this manual. This transmitter must not be co-located or operating in conjunction with any other antenna or transmitter. This equipment should be installed and operated with a minimum distance of 20cm between the radiator and your body. The availability of some specific channels and/or operational frequency bands are country dependent and are firmware programmed at the factory to match the intended destination. The firmware setting is not accessible by the end user.

## FCC SDOC SUPPLIER'S DECLARATION OF CONFORMITY

Arovast Corporation hereby declares that this equipment is in compliance with the FCC Part 15 Subpart B. The declaration of conformity may be consulted in the support section of our website, accessible from [www.levoit.com](http://www.levoit.com)

# WARRANTY INFORMATION

Product Name	EverestAir™ Smart True HEPA Air Purifier
Model	LAP-EL551S-AUS LAP-EL551S-AUSR LAP-EL551S-WUSB
<i>For your own reference, we strongly recommend that you record your order ID and date of purchase.</i>	
Date of Purchase	
Order ID	

## Terms & Policy

Arovast Corporation (“Arovast”) warrants this product to the original purchaser to be free from defects in material and workmanship, under normal use and conditions, for a period of 2 years from the date of original purchase.

Arovast agrees, at our option during the warranty period, to repair any defect in material or workmanship or furnish an equal product in exchange without charge, subject to verification of the defect or malfunction and proof of the date of purchase.

**There is no other express warranty. This warranty does not apply:**

- If the product has been modified from its original condition;
- If the product has not been used in accordance with directions and instructions in the user manual;
- To damages or defects caused by accident, abuse, misuse or improper or inadequate maintenance;
- To damages or defects caused by service or repair of the product performed by an unauthorized service provider or by anyone other than Arovast;
- To damages or defects occurring during commercial use, rental use, or any use for which the product is not intended;
- To damages or defects exceeding the cost of the product.

Arovast will not be liable for indirect, incidental, or consequential damages in connection with the use of the product covered by this warranty.

This warranty extends only to the original consumer purchaser of the product and is not transferable to any subsequent owner of the product regardless of whether the product is transferred during the specified term of the warranty.

This warranty does not extend to products purchased from unauthorized sellers. Arovast’s warranty extends only to products purchased from authorized sellers that are subject to Arovast’s quality controls and have agreed to follow its quality controls.

All implied warranties are limited to the period of this limited warranty.

This warranty gives you specific legal rights and you may also have other rights which vary from state to state. Some states do not allow the exclusion or limitation of incidental or consequential damages, so the above limitation or exclusion may not apply to you.

If you discover that your product is defective within the specified warranty period, please contact Customer Support via [support@levoit.com](mailto:support@levoit.com). **DO NOT** dispose of your product before contacting us. Once our Customer Support Team has approved your request, please return the product with a copy of the invoice and order ID.

Every Levoit product automatically includes a 2-year warranty. To make the customer support process quick and easy, register your product online at [www.levoit.com/warranty](http://www.levoit.com/warranty).

This warranty is made by:

Arovast Corporation  
1202 N. Miller St., Suite A  
Anaheim, CA 92806

# CUSTOMER SUPPORT

If you have any questions or concerns about your new product, please contact our helpful Customer Support Team.

## **Distributed by Arovast Corporation**

1202 N. Miller St., Suite A  
Anaheim, CA 92806

**Email:** support@levoit.com

**Toll-Free:** (888) 726-8520

## **Support Hours**

Mon–Fri, 9:00 am–5:00 pm PST/PDT

\*Please have your order invoice and order ID ready before contacting Customer Support.



The energy efficiency of this ENERGY STAR certified model is measured based on a ratio between the model's CADR for Smoke and the electrical energy it consumes, or CADR/Watt.

# ATTRIBUTIONS

Amazon, Alexa, and all related logos are trademarks of Amazon.com, Inc. or its affiliates.

Google, Android, and Google Play are trademarks of Google LLC.

App Store® is a trademark of Apple Inc.

Wi-Fi® is a registered trademark of Wi-Fi Alliance®.

iOS is a registered trademark of Cisco Systems, Inc. and/or its affiliates in the United States and certain other countries.

The Bluetooth® word mark and logos are registered trademarks owned by Bluetooth SIG, Inc. and any use of such marks by Arovast Corporation is under license. Other trademarks and trade names are those of their respective owners.





/LEVOITLIFESTYLE



/LEVOIT



/LEVOITLIFESTYLE



/LEVOITLIFESTYLE



LEVOIT.COM

**lëvoit<sup>®</sup>**