



ECOVACS GOAT

O800 RTK/O1200 RTK

Instruction Manual

1. Original Instructions

IMPORTANT READ CAREFULLY BEFORE USE KEEP FOR FUTURE REFERENCE

Read the instructions carefully. Make sure you understand the instructions and be familiar with the controls and the proper use of the appliance. Please understand that you can reduce the risk by following the instructions and warnings in this manual, but you cannot eliminate all the risks. Lawn Mowing Robot (hereinafter referred to as "ECOVACS GOAT") has many built-in safety sensors, however, safety risks still exist. All related residual risks have been described or informed in this manual.

Description of intended use: Intelligent lawn mowers are mainly used in mowing grass, especially in parks, private villa yards, and football fields.

For machines used in public areas, that warning signs shall be placed around the working area of the machine.

They shall show the substance of the following text: **WARNING!** Automatic lawnmower!

Keep away from the machine! Supervise children!

DO NOT modify the mower by yourself. Modifications could interfere with mower operations, result in serious injury and/or damage, or void the Limited Warranty. Use only Ecovacs approved parts and accessories.

WARNING

Never allow children, persons with reduced physical, sensory or mental capabilities or lack of experience and knowledge or people unfamiliar with these instructions to use the machine, local regulations may restrict the age of the operator. To avoid using the machine and its peripherals in bad weather conditions especially when there is a risk of lightning.

Before each mowing session, check that all parts of the mower can function normally.

Periodically inspect the area where the machine is to be used and remove all stones, sticks, wires, bones, and other foreign objects.

NEVER allow children to touch the power supply unit, charging station, blades, the battery compartment, or any parts with gaps such as the wheels.

WARNING

Never to operate the machine and/or its peripherals with defective guards or shields, or without safety devices, or if the cord is damaged or worn.

Keep away from the rotating blades! DO NOT put hands or feet under or near the rotating blades.

Keep a safe distance from the mower when operating.

DO NOT overreach. Keep your balance at all times and always be sure of the footing on slopes. Walk, never run while operating the machine or its peripherals.

WARNING

Never allow children to be in the vicinity or play with the machine when it is operating.

WARNING

DO NOT touch moving hazardous parts before they have come to a complete stop.

WARNING

For the purposes of recharging the battery, only use the detachable supply unit provided with this appliance (CH2492/CH2492B).

This appliance contains batteries that are only replaceable by skilled persons.

Safe Usage:

Not to connect a damaged cord to the supply or touch a damaged cord before it is disconnected from the supply for the reason that damaged cords can lead to contact with live parts; keep extension cords away from moving hazardous parts to avoid damage to the cords which can lead to contact with live parts; to connect the machine and/or its peripherals only to a supply circuit protected by a residual current device (RCD) with a tripping current of not more than 30 mA.

Unplug the Power Supply from the power socket and then untangle when the power cord or the extension cable is damaged or entangled during use. During the operation, pull the body of the plug rather than the cord to avoid the hazard. Contact Customer Service and let the skilled professional to repair or replace the cord. Please use the extension cable manufactured by ECOVACS. If you have any problem, contact Customer Service.

If the SUPPLY CORD is damaged, it must be replaced by the manufacturer, its service agent

or similarly qualified persons in order to avoid a hazard.

Press the STOP Button at once when the mower makes the abnormal sound or raises the alarm.

In case of leakage of electrolyte flush with water or neutralizing agent, ask for medical help once it gets contact with the eyes etc.

If there are abnormal vibrations, please restart the mower. If the problem persists, please Contact Customer Service.

Instructions to always wear substantial footwear and long trousers while operating the machine with a manual controller.

Additionally when using the manual controller

- a) Mow only in daylight or in good artificial light.
- b) Avoid operating the machine in wet grass.
- c) Do not operate the machine when barefoot or wearing open sandals. Always wear substantial footwear and long trousers.
- d) Always be sure of your footing on slopes.
- e) Use extreme caution when reversing the machine towards you.
- f) Always switch on the motor according to instructions with feet well away from the blade(s).

Device Update

Typically, some devices are updated bi-monthly, but not always so specific.

Some devices, especially those that went on sale more than three years ago, will only be updated if a critical vulnerability is found and fixed.

European Union Compliance Statement

Information on Disposal for Users of Waste Electrical & Electronic Equipment



This symbol on the product or on its packaging indicates that used electrical and electronic products should not be mixed with unsorted municipal waste. For proper treatment, it is your responsibility to dispose of your waste equipment by arranging to return it to designated collection points.

Disposing of this product correctly will help save valuable resources and prevent any potential negative effects on human health and the environment, which could otherwise arise from inappropriate waste handling.

To return your used device, please use the return and collection systems or contact the retailer where the product was purchased, which is free of charge, please contact your local authority for further details of your nearest designated collection point.

Penalties may be applicable for incorrect disposal of this waste, in accordance with your national legislation.

Information on Disposal for Users of used batteries



This symbol means that batteries and accumulators, at their end-of-life, should not be mixed with unsorted municipal waste. Your participation is an important part of the effort to minimize the impact of batteries and accumulators on the environment and on human health. For proper recycling you can return this product or the batteries or accumulators it contains to your supplier or to a designated collection point, which is free of charge.

Disposing of this product correctly will help save valuable resources and prevent any potential negative effects on human health and the environment, which could otherwise arise from inappropriate waste handling.

Penalties may be applicable for incorrect disposal of this waste, in accordance with your national legislation.

there are separate collection systems for used batteries and accumulators.

Please, dispose of batteries and accumulators correctly at your local community waste collection/recycling center.

Restriction of the use of certain hazardous substances (RoHS) Directive

Ecovacs Home Service Robotics Co., Ltd. hereby declares the whole product including parts (cables, cords, and so on) meets the requirements of RoHS Directive 2011/65/EU and amendment Commission Delegated Directive (EU) 2015/863 on the restriction of the use of certain hazardous substances in electrical and electronic equipment ("RoHS recast" or "RoHS 2.0").

Radio Equipment Directive

Ecovacs Home Service Robotics Co., Ltd. hereby declares that the product listed in this section comply with the essential requirements and other relevant provisions of the Radio Equipment Directive 2014/53/EU.

Machinery Directive

Ecovacs Home Service Robotics Co., Ltd. hereby declares that the product listed in this section comply with the essential requirements and other relevant provisions of the Machinery Directive 2006/42/EC.







Europe Authorised Representative:













ECOVACS Europe GmbH
Holzstrasse 2 | D-40221 Düsseldorf | Germany

Ecovacs Home Service Robotics Co., Ltd. hereby declares that the product comply with the essential requirements and other relevant provisions of the RoHS Directive 2011/65/EU and amendment Commission Delegated Directive (EU) 2015/863, the Radio Equipment Directive 2014/53/EU and the Machinery Directive 2006/42/EC.

The declaration of conformity can be viewed at the following address: <https://www.ecovacs.com/global/compliance> .

	Class III appliance
	Direct current
	Alternating current
	This product conforms to the applicable EC Directives.
	Polarity of the charging port
	Before charging, read the instructions.

SYMBOLS

	WARNING— Read instruction manual before operating the machine.
	
	WARNING— Keep a safe distance from the machine when operating.
	
	WARNING— Do not ride on the machine.
	
	WARNING— Operate the disabling device before working on or lifting the machine.
	
	CAUTION— Do not touch rotating blade.
	

2. What's in the Box

2.1 Package Contents

ECOVACS GOAT O800 RTK

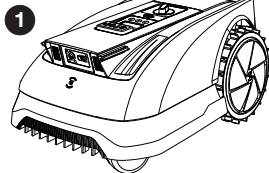

ECOVACS GOAT O1200 RTK

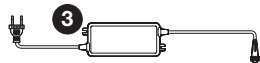
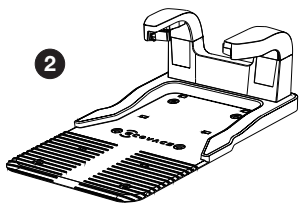
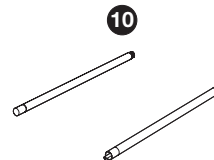
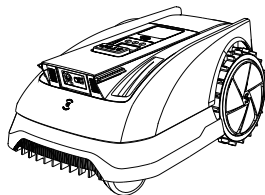

7

8

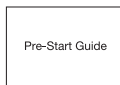

1 ECOVACS GOAT O800 RTK (including Blade*3) / O1200 RTK (including Blade*3)

2 Charging Station

3 Power Adapter

4 Charging Station Fastening Anchors

5 Spare Blade Kit

6 Allen Key

7 Instruction Manual

8 Pre-Start Guide

9 RTK Reference Station Fixing Anchor

10 RTK Reference Station Mounting Poles

11 RTK Reference Station

12 Power Cable Loop Fastener

13 RTK Reference Station Cable Clips

14 RTK Pole Assembly Screw

15 Spring Washer

2.2 Views and Functions

1 Top View(O800 RTK)

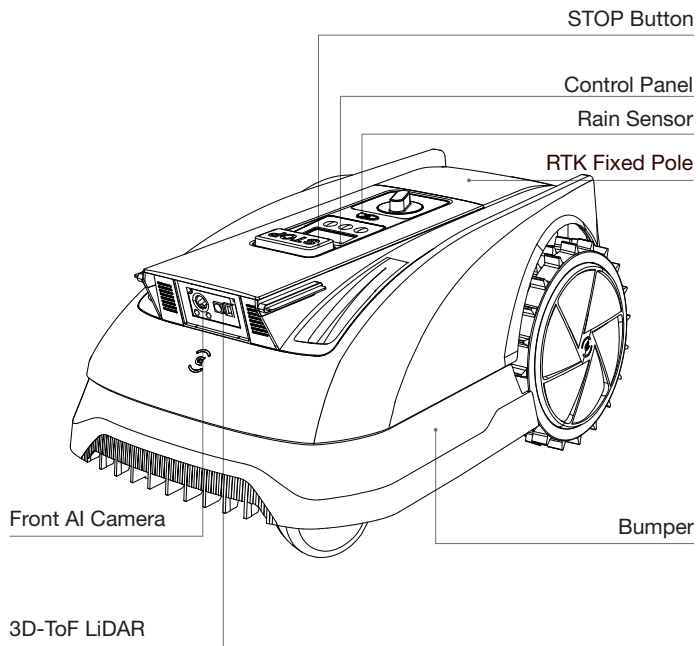

Top View(O1200 RTK)

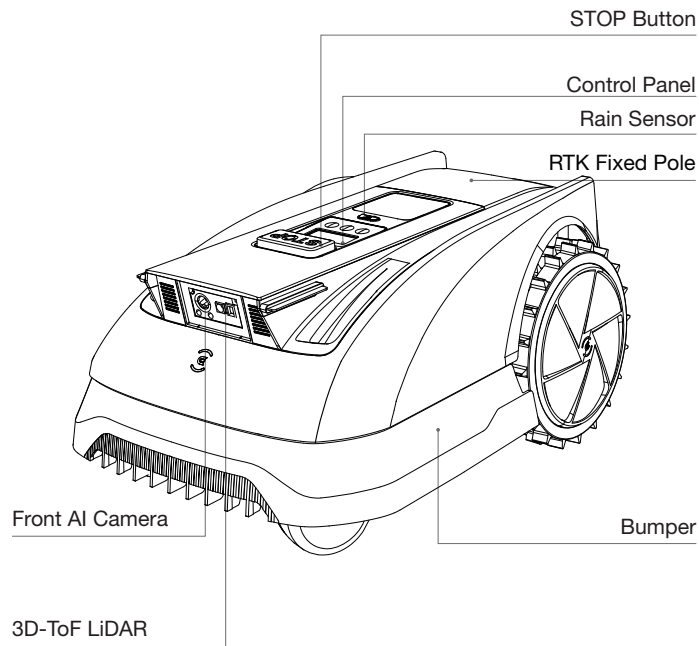

SENSORS

Name	Description
Front AI Camera	Perceive the environmental information in front of the robot, identify special targets, and help the robot to interact with the user intelligently. Horizontal: 150 degrees; Vertical: 80 degrees (what you see is what you get)
3D-ToF LiDAR	Perceive obstacle information in front of the robot and help the robot to avoid obstacles actively. Range: Detect the longitude and latitude coordinates of the robot position. Horizontal: 90 degrees; Vertical: 70 degrees (what you see is what you get) The farthest distance is 3~4m(9.84'~13.12').
Rain sensor	Detect whether it is raining in the current environment, and help the robot decide whether to continue working.
RTK Reference Station	Help the mobile robot obtain the relative distance between itself and the Locator Beacon, which is used to assist the robot to build a home map. Range: With the Beacon as the center, the effective range of the signal is within a radius of 300~400m(984.25'~1312.34').

2 Bottom View

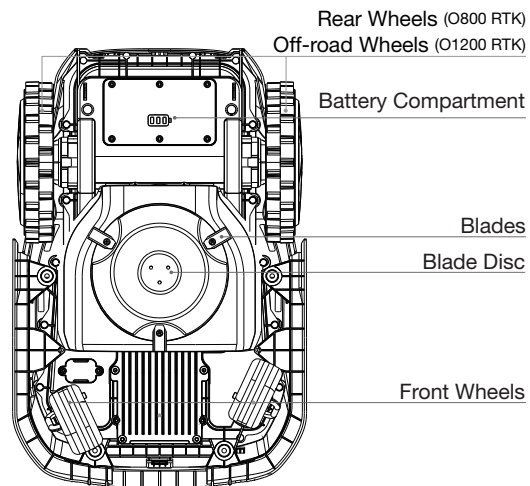

3 Back View

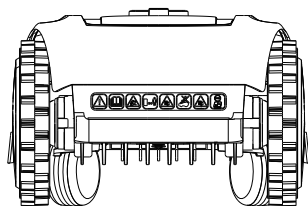

4 Charging Station and RTK Reference Station

RTK Reference Station

RTK Indicator Light

Station Indicator Light

Charging Station

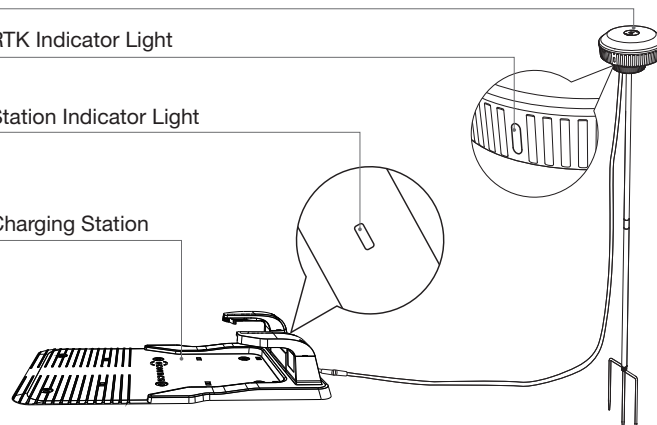

Charging Station Light

Solid Blue: Powered on/ Fully charged.

Flashing Blue: Charging.

RTK Reference Station Light

Solid Blue: Strong signal.

Flashing Blue: Poor signal. Please select a new location for installation.

3. Get Your GOAT Ready



3.1 GOAT and App Setup

1 Start GOAT and Set PIN Code

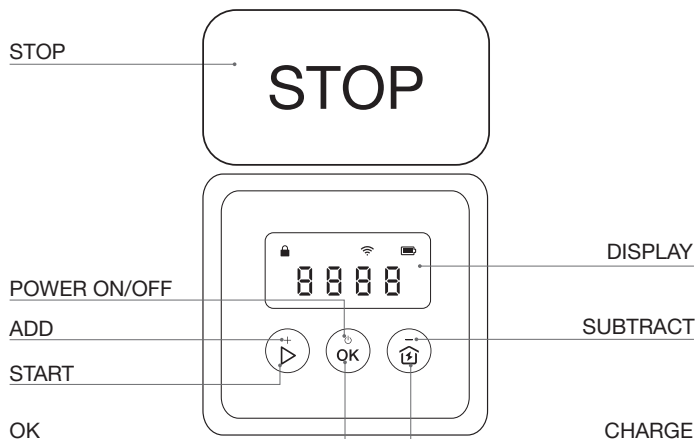



Control Panel:









Panel Icons:

Lock		GOAT locked. Please enter PIN code to unlock the GOAT. If it flashes, please set the PIN code.
WiFi		Connected to Wi-Fi.
Battery		Battery level. White --- More than 15% charge. Red --- Less than 15% charge Flashing indicates charging; Steady indicates in use or fully charged.

Buttons and Functions

Buttons	Functions
 --> OK	Start mowing. Resume working.
OK	Press to confirm. Press and hold for 3 seconds to power on the GOAT.
 --> OK	Send the GOAT back to the Charging Station to get charged.
STOP	Stop the GOAT.
	Press and hold for 5 seconds to reset the GOAT.
[+]	For a bigger number.
[-]	For a smaller number.
	Press and hold for 3 seconds to enable Bluetooth pairing.
	Press 5 times to show the battery level

Panel Display Reads:

Display	Description
	Standing by. No task assigned
	Current Battery Level (For example, the number shown in the image represents the current battery level as 100%.)
	STOP GOAT is paused. Please press ▶ --> OK to continue working, or ⏪ --> OK to return to the charging station.
	ON GOAT is working
	OTA GOAT is undergoing OTA updates
	E and a 3-digit Error Code. Go to the Troubleshooting section of this manual or visit https://www.ecovacs.com/global for the meaning of the Error Code messages and recommended solutions.

1.Start GOAT:

Press and hold [OK] for 3 seconds on GOAT and the digital tube display will flash as below.

Note: Your GOAT will be automatically powered on when it docks at the Station.

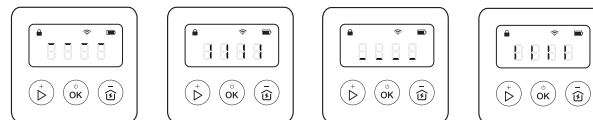





2.Set PIN Code:

When the GOAT is off map or to be powered on or reset, it will automatically be locked. You can unlock it by entering the right PIN code.

Set the PIN code when the display shows as below.

Press [+] or [-] to select the PIN code numbers one by one. After the first digit is decided, press [OK] to confirm, and the cursor will move to the next digit.

1. If the  is flashing, please set the PIN code.
2. If the  is solid, enter the previously set PIN code.
3. Once unlocked, the  will disappear. If unlocking fails, the  will flash again, prompting you to reset the PIN code.

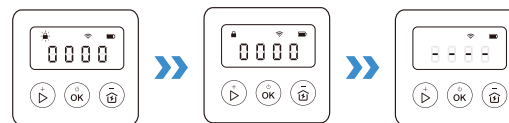

Note:

- 0000 is an invalid PIN code.
- PIN code is to be entered twice to confirm the setting.
- If you enter the wrong numbers while setting the PIN code, the setting process will start all over again.
- You may change the PIN code on the App.

2 Download the ECOVACS HOME App

Scan the QR code on the GOAT, Download and install the ECOVACS HOME App, complete the registration, and log in. You may also find the Instruction Manual and How-to-use by scanning the QR code.



3 Connect GOAT to the App

Note:

- Your mobile phone is connected to a Wi-Fi network.
- The 2.4GHz band wireless signal is enabled on your router.
- Make sure your GOAT and your phone are in the same 2.4GHz network router environment.
- Ensure your phone has Bluetooth function and your GOAT is within the effective distance of 10 m.

Bluetooth Connection and Wi-Fi Connection

1. Turn on the Bluetooth on your phone.
2. Scan the QR Code on GOAT or select GOAT manually on the App.
3. Follow the instructions on the App to complete the Bluetooth connection and Wi-Fi connection.



4. on GOAT's panel display will light up after successful connection.

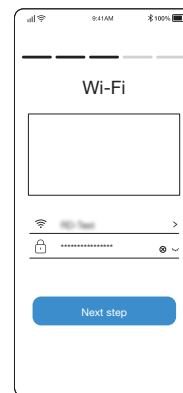

How to unbind your ECOVACS GOAT?

Allowing binding to one App account currently, your ECOVACS GOAT is unable to be bound to another App account before unbinding. You can unbind your ECOVACS GOAT in the App. Feel assured to take this operation which would not erase the working data such as schedules of your ECOVACS GOAT. You also can cancel the account in by clicking the small triangle next to the device name to delete the machine.

3.2 Station Installation

1 Install the Charging Station

1. Ensure the Charging Station is in a place with strong Wi-Fi signal for better remote control.

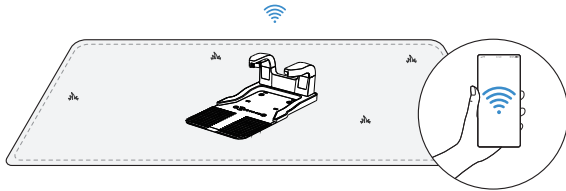

2. Place the Charging Station on an open and flat lawn, avoiding any slope, rocks, or shadow coverage. Ensure that there are no objects (e.g., fences or plants) within 40cm (15.75") on either side and 2m (6.56') in front.

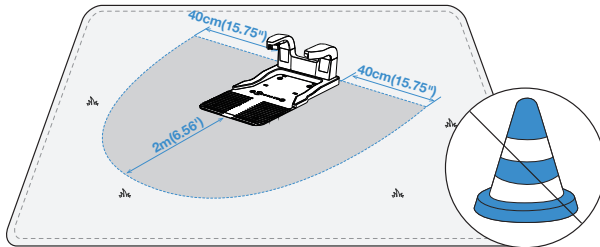

3. Make sure that the grass around the Charging Station is no longer than 6cm (2.36"). Overgrown grass may affect recharging.

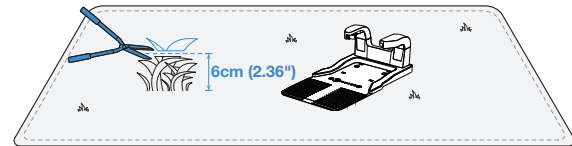

4. If you want to fix the Charging Station to the ground, use the Charging Station Fastening Pegs and the Allen key.

Note: You may want to do this after you have settled down everything.

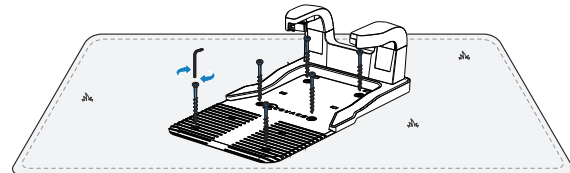

5. Connect the longer cable to the Power Adapter. Please align the notch (A) with the groove (B) and screw the nut until they are locked into each other.

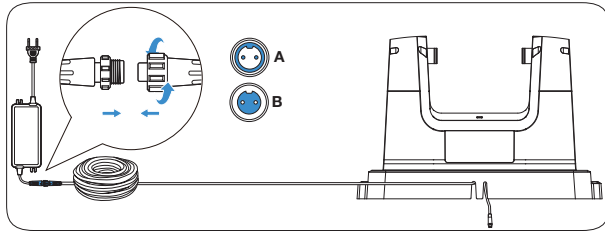

Note: The Charging Station has two cable ports: the longer one is for the Power Adapter and the short one is for the RTK Reference Station.

6. Connect the Charging Station Plug to the power supply and ensure the blue light is steady on.

Note:

- Please ensure the Power Adapter is positioned 30cm (11.8") above the ground to prevent water and moisture damage.
- Please plug the device into an indoor outlet or an outdoor waterproof outlet.
- You can choose to buy the Extension Cable by connecting it to Power Interface if needed.

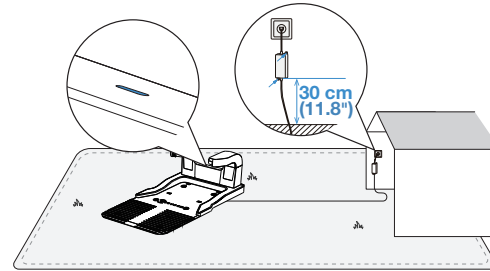

2 Install the RTK Reference Station

Note: You may explore more accessories for easier installation of the RTK Reference Station at online store.

1. Choose an open area to place the RTK Reference Station, a spot recommendedly at least 2m (6.56") away from buildings and trees for better RTK performance.

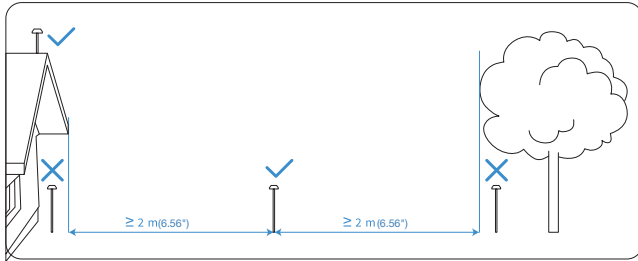

2. Assemble the upper and lower parts of the RTK Station Mounting Poles, ensuring the buckle clicks securely into place.

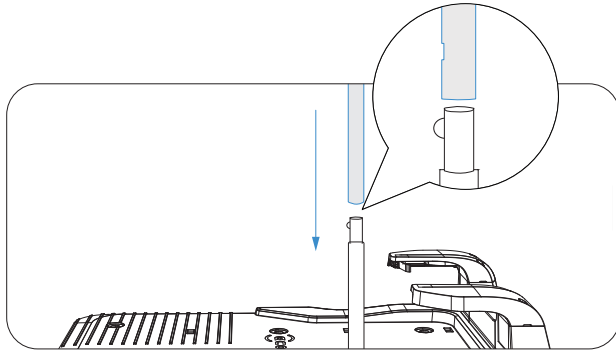

3. Attach the RTK Reference Station signal head to the RTK Station Mounting Pole by tightening the RTK Pole Assembly Screw.

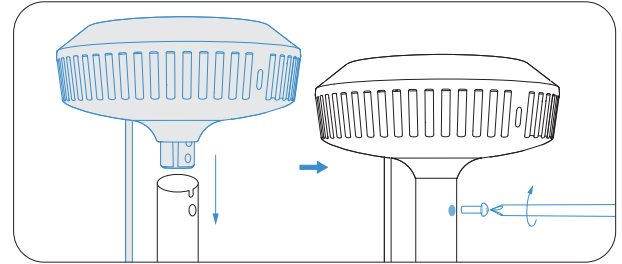

4. Insert the triangular peg into the mounting pole and tighten it securely.

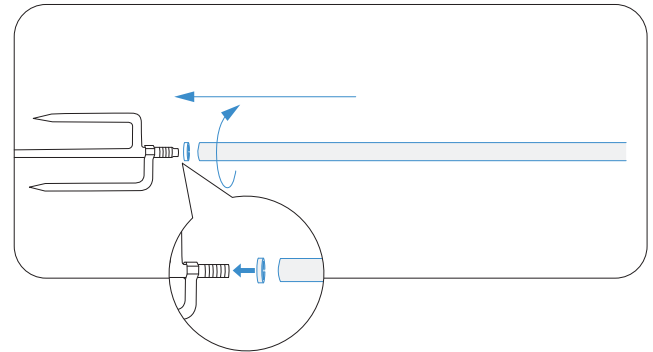

5. Connect the RTK Reference Station power cable to the Charging Station power cable and tighten the nut.

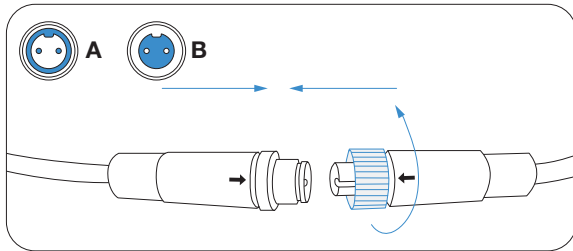

Note: The Charging Station has two cable ports: the longer one is for the Power Adapter and the short one is for the RTK Reference Station.

6. After powering on, please wait one minute to check the indicator light status. If the RTK Reference Station indicator remains steady blue, the location is ideal with good signal; if it flashes, relocate the RTK Reference Station, until you find the perfect position.

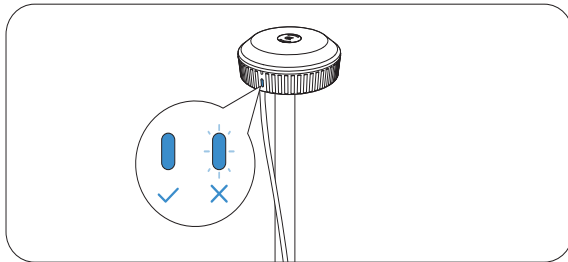

7. After locating the perfect spot, insert the RTK Station Fixing Fork Peg into the ground.

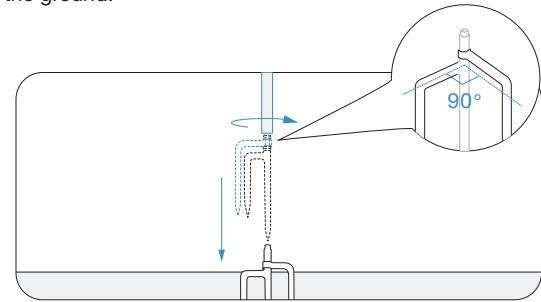

Note:

- DO NOT install the RTK Reference Station to a spot where the ground is soggy and mushy, otherwise the pole may easily tilt, thus undermining the working accuracy of the RTK Reference Station.
- The RTK Reference Station should be oriented vertically, as shown below:

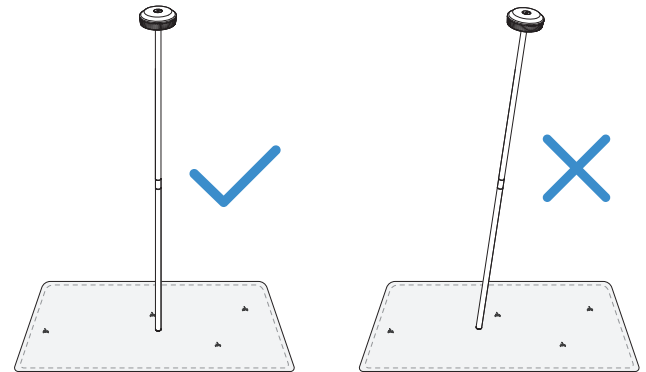

- Secure the RTK Reference Station power cable to the mounting pole with the RTK Reference Station Cable Clips and use the Power Cable Fastening Pegs to secure other cables to the ground.

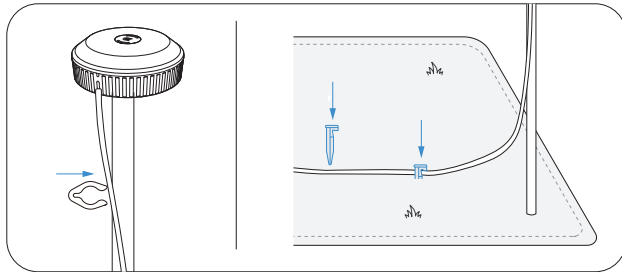

3.3 Charge Your GOAT

- Fully charge your GOAT before first use.
- Place it at the Charging Station for charging. The  on GOAT's panel will flash white, displaying the current battery level on the screen. The indicator light on the Charging Station will flash blue during charging and turn solid blue when fully charged, with the screen showing "100".

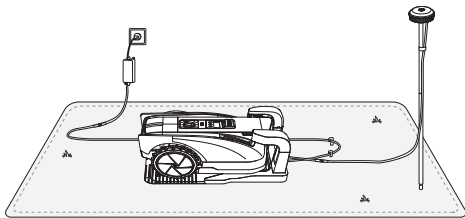

4. Map Your Garden

4.1 Notes Before Mapping

- If your lawn is split into two parts by a road with a height of less than 3cm (1.18"), you can create a path to connect the two parts when mapping.
- If your lawn is split into two parts by a road with a height of more than 3cm (1.18"), you can place a ramped object (such as an uphill mat) that is as high as the road and wider than 1.2m (3.94') before mapping, to create a path to connect the two parts when mapping.

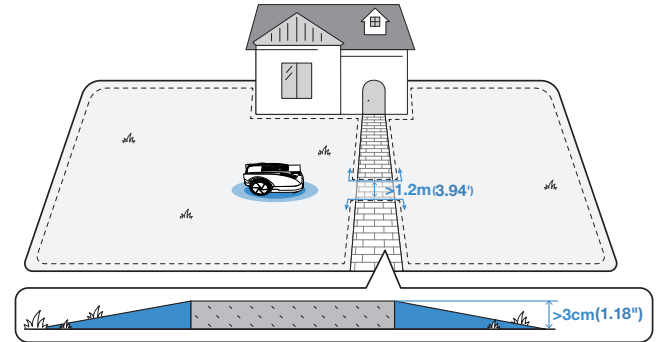

- Do not create the virtual boundary on a slope that exceeds 17%.

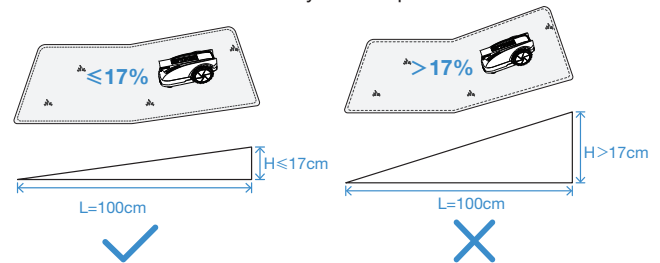

Note: If the robot needs to pass through a narrow passage, ensure that the minimum width of the passage is greater than 0.75m (2.46') meters.

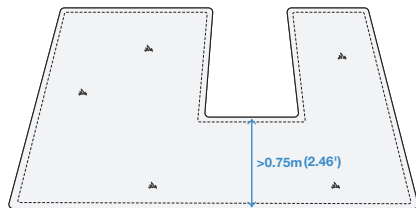

- For the very first attempt at mapping, make sure your GOAT docks properly at the Charging Station and starts from there.

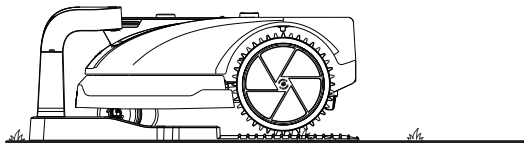

- The battery level of your GOAT is more than 50%.

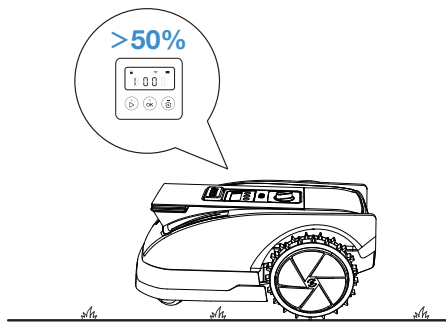

4.2 Create a Map

- Control the GOAT on the Ecovacs HOME App and follow it within 6m (19.69') for steady Bluetooth connection. You may switch between different mapping modes as the App indicates.
- If the height difference at the edge of the lawn is more than 3cm (1.18") , please keep your GOAT at least 10cm (3.94") from the edge.

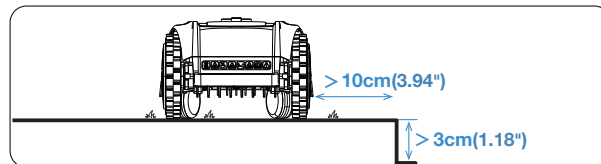
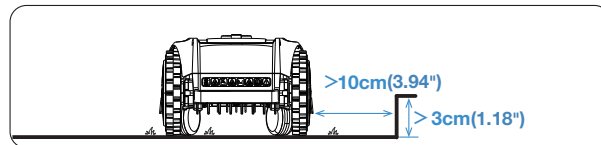
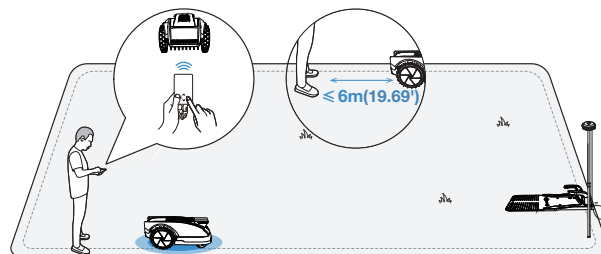

- Make sure that the turning angle is greater than 90° .

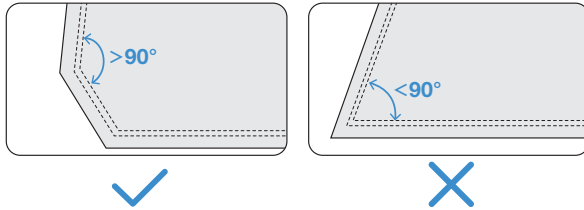

- When finishing mapping, close the loop at the starting point. Follow the App instruction to complete. You may carry on to map a new area or set up no-entry zones.

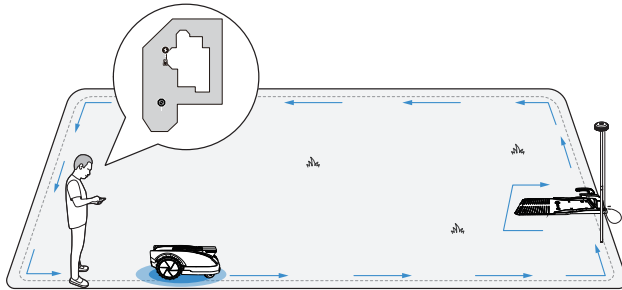

4.3 Set up No-Entry Zones, Areas, and Paths

You may explore more mapping features on the App.

1 No-Entry Zones

- Though GOAT can automatically adjust its direction when hitting solid obstacles such as stones or trees, it is still necessary to set up No-Entry Zones for objects you want to protect, such as a flowerbed, a trampoline and a vegetable plot.
- And to protect your GOAT, areas where GOAT is prohibited from passing also should be set as No-Entry Zones, such as raised tree roots, exposed wire, pool and slope that exceeds 45%.

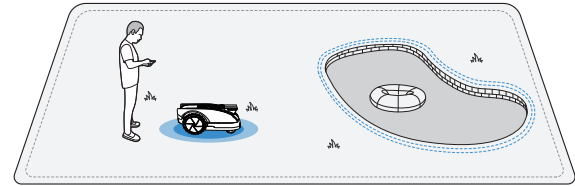

- Follow the instructions on the App.
- Control your GOAT to return to the Charging Station after the setup completes.

Note: It is recommended to keep GOAT 30cm (11.8") away from the boundaries of dangerous areas such as a pond or cliff.

2 New Areas and Area-connecting Paths

- Control GOAT to the new area to be mapped.
- Mapping the new area based on the regional environment.

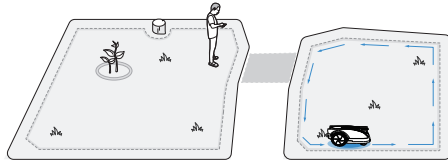

- A path is intended to connect two separate areas or to connect the edge of a lawn to the Charging Station.
- GOAT can automatically generate a path when starting from inside one area and reaching another area. You may edit the path as you like on the App.
- Please ensure that the passable width of the path for GOAT is greater than 1.2 m (3.94').

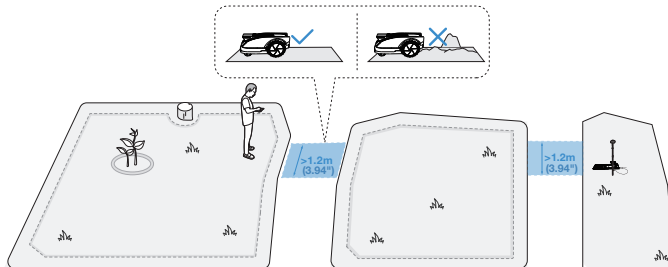

5. Know Your GOAT Better

5.1 Rain Sensor

- Mowing under heavy rain will not bring out the best result. Your GOAT, equipped with the Rain Sensor, will pause mowing and return to the Charging Station automatically when a certain amount of rainwater is detected.

When the rain stops, the lawn may still be wet. For a better mowing result, your GOAT will resume mowing 3 hours by default after the Rain Sensor detects that the rain has stopped.



5.2 Animal protection

- With the aim of protecting nocturnal animals, GOAT will stop moving at night. You also can inactivate it on your GOAT or via the App to mow at night.



5.3 Obstacle Avoidance

- Equipped with ToF Sensor, your GOAT can detect objects and avoid them in advance.

The height of obstacles to be avoided can be set on your ECOVACS HOME App. Moreover, some obstacles can precisely be avoided by AI recognition.



5.4 Safety and PIN Code Protection

- The PIN code you set for your GOAT at the very beginning is used to prevent the device from being stolen or operated by children. When GOAT is off map or to be started or reset, it will automatically be locked. You can unlock it by entering the right PIN code.

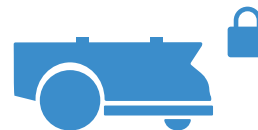

Note:

After five incorrect attempts, wait 30 minutes before retrying. You may change the PIN code on the App.

6. Time for Mowing

6.1 Tips Before First Mowing

- Cut the grass to a height of no more than 10cm (3.94") with your manual lawnmower and clear away obstacles including debris, piles of leaves, toys, wires and stones.
- Do not let your children play on the lawn when your GOAT is mowing.

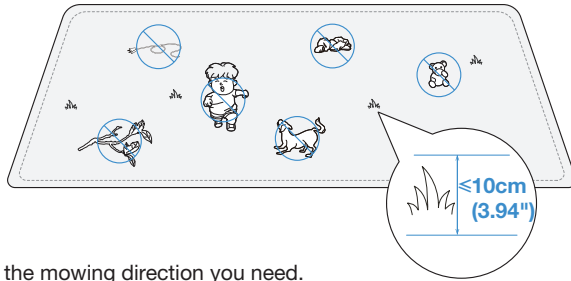

- Set the mowing direction you need.

Note: Your GOAT will adjust its direction after departing from the Station and go straight forward to mow by default.

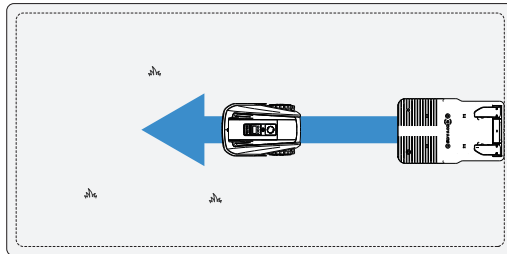

6.2 Basic Mowing Operations

1 Start Mowing

Press \triangleright , then [OK]. GOAT will start mowing. Or you can start mowing via the App.

Note: Make sure the grass has been cut to a height of no more than 10 cm with your manual lawnmower.

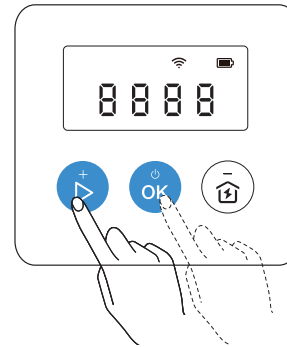

OR

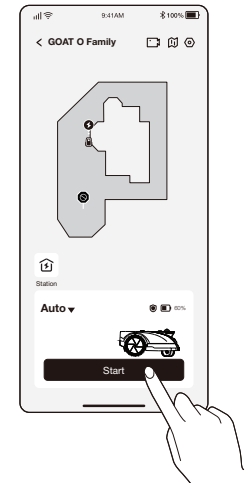

2 Pause and Resume

Press **STOP** to pause GOAT.

- For security, your GOAT will be locked after **STOP** is pressed, you can press **▶** then **[OK]** to continue the task or press **🏠** Charging to recharge. It cannot be started directly on the App.

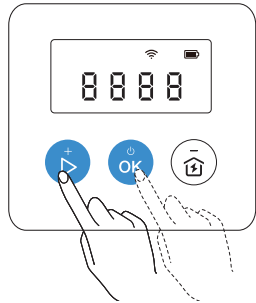

OR

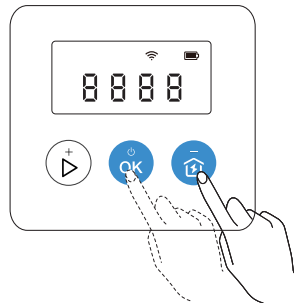

Pause the GOAT on the App.

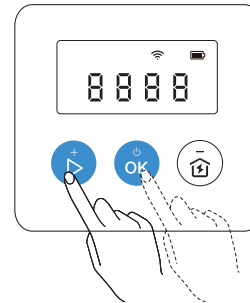
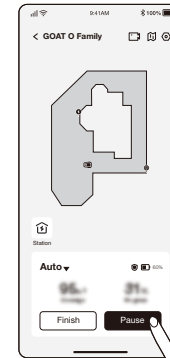

- You can pause and resume mowing directly through the App. Press **▶** and then **[OK]** on GOAT or operate on the App to resume mowing.

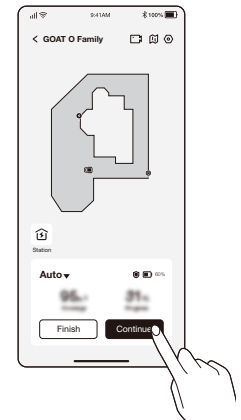

OR



3 Recharging

- After completing the mowing task, GOAT will return to the Station automatically.
- When ending the mowing process manually, you need to send GOAT to the Station by pressing  and then [OK], or tapping  on the App.

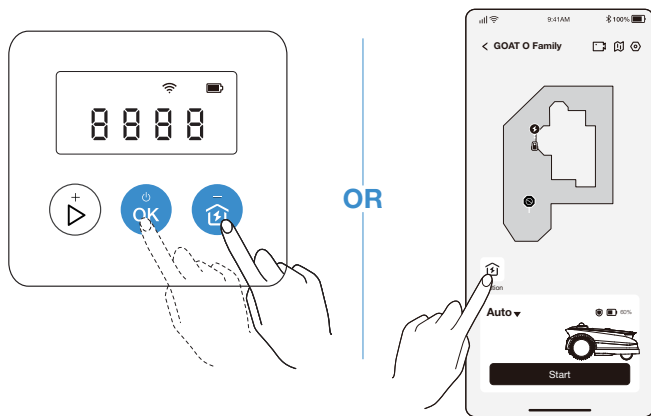

7. Maintenance

For better performance and longer life-span of your GOAT, please maintain it and replace any worn parts properly.

7.1 General Safety Precautions

- Always power off your GOAT before maintenance operation.
- Always wear protective gloves especially when replacing the Blades.
- Please lift your GOAT properly. Hold the handle and the head simultaneously when picking it up, ensuring the Blade Disc is facing downward.
- DO NOT use a high pressure sprinkler because high pressure water can enter the sealings and damage electronic and mechanical parts.

7.2 Routine Maintenance

1 Recommended Frequency

Part	Frequency
Front AI Camera	Wipe every 1 to 2 weeks
ToF Sensor	Wipe every 1 to 2 weeks
Blades	Replace every 4 to 6 weeks

Note: Please utilize only the original battery or that of the same model as specified by ECOVACS.

5 Battery Maintenance

- For long-time storage, it is recommended to charge GOAT every 6 months. The Limited Warranty does not cover battery damage caused by over-discharge. The battery CANNOT be charged when the ambient temperature is above 40°C/104°F or below 5°C/41°F. The recommended temperature for GOAT operation is between 5-40°C/41~104°F.
- The storage temperature range is -20-75°C/-4~167°F.

Note: The life-span of GOAT's battery depends on the frequency of usage and the total hours of use. It is also non-rechargeable. DO NOT dispose of disused or faulty batteries casually. Check with your Local Authority for advice.

7.3 Seasonal Maintenance

1 Storage Over the Winter

GOAT

1. Power off your GOAT after it is fully charged.
2. Clean it thoroughly.
3. Store it with water-proof and dust-proof coverings in a cool, well-ventilated, and dry place indoors.

Charging Station and RTK Reference Station

1. Unplug the Power Supply from the power socket.
2. Disconnect Power Supply from the Charging Station.
3. Mark the spot where you set the Charging Station and the RTK Station for reference in the new working season.
4. Store the Stations, the Power Adapter, and cables in a cool, well-ventilated, and dry place away from direct sunlight.

Note: It is necessary to put both Stations in the original position for working in a new season. Otherwise, it may lead to location faults or map invalidation.

2 Spring Restart

1. Remove all coverings from your GOAT and the Stations.
2. Assemble both Stations, putting them back to where they were in the last working season.
3. Check the cables for any damage or breaks and repair or replace as needed. Connect the cables that are safe and qualified to use.
4. Check the Blades for sharpness and replace them if necessary. Refer to the Maintenance section of this manual for detailed steps and tips.
5. Power on your GOAT and test if it is connected to the App and works properly.

8. Troubleshooting

If there is something wrong with your GOAT when working, you can consult the table below. The ECOVACS HOME App will also send detailed problem notifications. Please contact our Customer Service if the problems still exist.

Issue	Error Code	Cause	Solution
The Indicator Light on the Charging Station does NOT light up.	/	There is no power supply or the current and voltage are unstable.	<ol style="list-style-type: none"> 1. Ensure the Charging Station is properly connected to a power supply, and the plug is inserted into a suitable socket. 2. If the issue persists, please contact the Customer Service.
The GOAT stops within the working area.	E504 E505 E650	There is an issue with the RTK Reference Station's location or RTK signal.	<ol style="list-style-type: none"> 1. Check if the RTK Reference Station has been moved. If it has, place it back in its original position. 2. Check if the light is steady. If it flashes, find a location with better signal and remap. 3. Please control/place the GOAT back the Charging Station and restart.
	/	The GOAT fails to dock at the Charging Station.	<ol style="list-style-type: none"> 1. Ensure the Charging Station is connected to a power supply. The Indicator Light should be steady blue. 2. Check if the reflective film on the Charging Station is blocked. 3. Check for obstacles near the Charging Station, and remove them if necessary. 4. Ensure the Charging Station is installed correctly. If not, reinstall it properly. 5. If the problem still exists, please contact Customer Service.
	E621 E622 E623 E627	The GOAT is lifted or trapped for a long time.	<ol style="list-style-type: none"> 1. It is recommended to turn off the GOAT to avoid injury, then place it back on a level lawn. 2. If the GOAT detects that the issue has been resolved, the error code will disappear. 3. If the error code is still displayed, please turn off the GOAT and check for any obstacles or conditions that might be causing it to get trapped. 4. Remove any obstacles that may cause the GOAT to get stuck, or set up a no-entry zone.

GOAT stops working and returns to the Charging Station.	E674	The battery temperature is out of range.	<ol style="list-style-type: none"> 1. Place the GOAT in an area with an appropriate temperature, or wait until the battery temperature returns to normal. 2. Restart the GOAT. 3. If the problem persists, please contact the Customer Service.
	/	The battery voltage is low.	Wait until the battery is fully charged.
	/	Rain Sensor is triggered or it is the end of a scheduled task.	Normal phenomenon, please wait until the task resumes, or you can change the rain delay setting or schedule on the APP.
The GOAT is not operating at the correct time.	/	The schedule for the GOAT is not correct or the timezone is not correct.	Please check if the settings are correct.
	/	The GOAT automatically starts the recutting task, due to reasons like recharging, rain delay, or an uncut shadow area from last time because of poor lighting.	<ol style="list-style-type: none"> 1. The recutting of uncut shadow areas is set to start on the next morning by default. The next day, you can set the proper schedule to allow the GOAT to work within the allowed time. 2. You can also set the "Animal Protection" time on the APP to limit the time the GOAT can operate.
Other Issues or Situations.	/	Any other abnormal phenomena.	<ol style="list-style-type: none"> 1. You can check the error message on the APP for detailed information. 2. Resolve the issue, and then you can restart the GOAT to resume operation. 3. If the problem still exists, please contact the Customer Service.

9. Technical Specifications

Basic Information	Product Name	Lawn Mowing Robot	
	Model	ECOVACS GOAT O800 RTK	ECOVACS GOAT O1200 RTK
	Brand	ECOVACS	
	Dimensions: Length (mm) × Width (mm) × Height (mm)	600*400*263 (23.62"*15.75"*10.35")	600*400*260 (23.6"*15.7"*10.24")
	Net Weight (kg) (Battery Included)	11(24.3 lb)	11.5(25.4lb)
Mower Parameters	Rated Voltage	18V \equiv	18V \equiv
	Working Capacity (m ²)	800	1200
	Cutting Width (cm)	22(8.66 in.)	
	Cutting Height (cm)	3-8(1.2"-3.2")	
	Charging Time (min.)	180	195
Noise Emissions	Measured Sound Power Level L _{WA}	57 dB(A)	
	Sound Power Uncertainties K _{WA}	3 dB(A)	
	Sound Pressure Level L _{PA}	49 dB(A)	
	Sound Pressure Uncertainties K _{PA}	3 dB(A)	
Connectivity Frequency Range	Bluetooth®	2400MHz ~ 2483.5MHz	
	Wi-Fi	2400MHz ~ 2483.5MHz	
	RTK(GNSS)	GPS, Beidou, Galileo, GLONASS	
	RTK(LoRa)	863-870MHz	
MAX. radio- frequency power	Bluetooth®	≤20dBm	
	Wi-Fi	≤20dBm	
	RTK	≤14dBm	

Driving Motor	Rated Speed (r/min)	2349	
	Top Speed (r/min)	3356	
Blade Motor	Speed (r/min)	2250	
Battery (Mower)	Battery Type	Lithium-ion	
	Rated Voltage	18V ===	18V ===
	Battery Capacity	4Ah	5.2Ah
RTK Reference Station	Usage Temperature	-40°C~+85°C	
	Storage Temperature	-40°C~+95°C	
Power Supply	Supply Unit Model	GC44-210180-2DG	GM95-210300-2DG
	Input Voltage	100-240~ 50-60Hz	
	Output Voltage	21V ===	
	Output Current	1.8A	3A
Station	Model	CH2492	CH2492B
	Input Voltage	21V ===	
	Input Current	1.8A	3A
	Output Voltage	21V ===	
	Output Current	1.8A	3A
	Output Voltage(RTK)	5V ===	
	Output Current(RTK)	1A	

Note: Technical and design specifications may be changed for continuous product improvement.

Explore more accessories at <https://www.ecovacs.com/global>.