

BRUSHLESS LAWN MOWER

Model No.: U20LM00-0A120

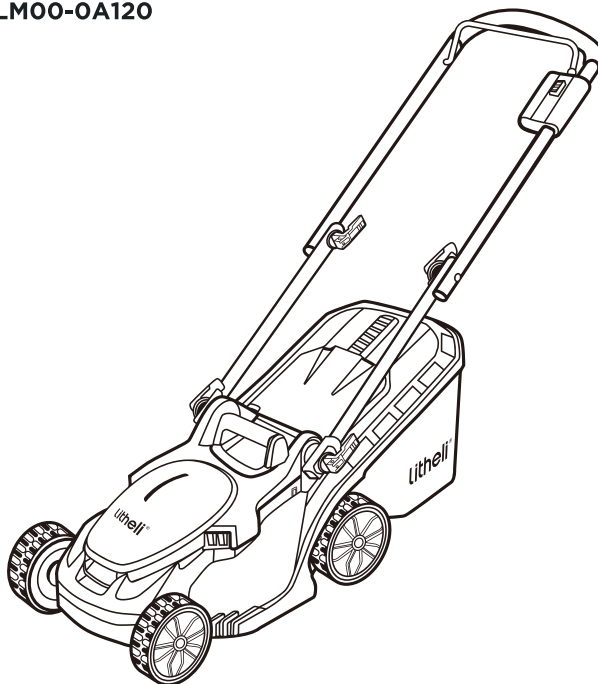

WARNING:

To reduce the risk of injury, the user must read and understand the user manual before using this product. Save this manual for future reference.

TABLE OF CONTENTS

Important Safety Instructions	02
Safety Symbols	08
Know Your Tool	11
Charging Your Battery	13
Assembly and Adjustment	15
Operation	18
Maintenance	24
Troubleshooting	30
Warranty	32

READ ALL INSTRUCTIONS!



WARNING: Some dust created by power sanding, sawing, grinding, drilling and other construction activities contains chemicals known to the state of California to cause cancer, birth defects or other reproductive harm. Some examples of these chemicals are:

- Lead from lead-based paints,
- Crystalline silica from bricks and cement and other masonry products, and
- Arsenic and chromium from chemically-treated lumber.

Your risk from these exposures varies, depending on how often you do this type of work. To reduce your exposure to these chemicals: work in a well-ventilated area, and work with approved safety equipment, such as those dust masks that are specially designed to filter out microscopic particles.

Important Safety Instructions



WARNING:

This machine was built to be operated according to the rules for safe operation included in this manual. As with any type of power equipment, carelessness or error on the part of the operator can result in serious injury. This machine is capable of amputating hands and feet and throwing objects. Failure to observe any of the safety instructions could result in serious injury or death.



WARNING:

When using electric lawn mowers, basic safety precautions should always be followed to reduce the risk of fire, electric shock, and personal injury, including the following:

FOR ALL LAWN MOWERS

- 1) Avoid Dangerous Environment - Do not use lawn mowers in damp or wet locations.
- 2) Do not Use in Rain.
- 3) Keep Children Away - All visitors should be kept at a distance from work area.

- 4) Dress Properly - Do not wear loose clothing or jewelry. They can be caught in moving parts. Use of rubber gloves and substantial footwear is recommended when working outdoors.
- 5) Use Safety Glasses - Always use face or dust mask if operation is dusty.
- 6) Use Right Tool - Do not use lawn mower for any job except that for which it is intended. Your lawn mower has been designed to perform only one job: to mow grass.
- 7) Do not Force lawn mower - It will do the job better and safer at the rate for which it was designed.
- 8) Do not Overreach - Keep proper footing and balance at all times.
- 9) Stay Alert - Watch what you are doing. Use common sense. Do not operate appliance when you are tired.
- 10) Store Idle lawn mower Indoors - When not in use, lawn mower should be stored indoors in dry, and high or locked-up place - out of reach of children.
- 11) Maintain lawn mower with Care - Keep cutting edge sharp and clean for best and safest performance. Follow instructions for lubricating and changing accessories. Keep handles dry, clean, and free from oil and grease.
- 12) Keep blades sharp.
- 13) Keep hands and feet away from cutting area.
- 14) Objects struck by the lawn mower blade can cause severe injuries to persons. The lawn mower should always be carefully examined and cleared of all objects prior to each mowing.
- 15) If lawn mower strikes a foreign object, follow these steps:
 - i) Stop lawn mower. Release the switch.
 - ii) Remove battery pack.
 - iii) Inspect for damage.
 - iv) Repair any damage before restarting and operating the lawn mower.
- 16) Use identical replacement blades only.

SAFETY INSTRUCTIONS FOR WALK-BEHIND LAWN MOWERS

 WARNING:
Grass bag components, the discharge cover, side discharge chute, mulching plug and trailing shield are subject to wear and damage, which could expose moving parts or allow objects to be thrown and could increase the risk of injury. For safety protection, frequently check all components and replace damaged components immediately with identical replacement parts, listed in this manual.

- 1.** Read this operator's manual carefully in its entirety before attempting to assemble this machine. Read, understand, and follow all instructions on the machine and in the manual operation. Be completely familiar with the controls and proper use of this machine before operating it. Keep this manual in a safe place for future and regular reference and for ordering replacement parts.
- 2.** Keep the area of operation clear of all persons, particularly small children, and pets.
- 3.** Before and while moving backwards with the mower, look behind and down for small children and other people.
- 4.** Keep clear of the discharge opening at all times. This machine is a precise piece of power equipment, not a plaything. Therefore, exercise extreme caution at all times. Your unit has been designed to perform one job: to mow grass. Do not use it for any other purpose.
- 5.** Thoroughly inspect the area where the equipment is to be used. Remove all stones, sticks, wire, toys and other foreign objects that could be tripped over or picked up and thrown by the blade. Thrown objects can cause serious personal injury.
- 6.** Plan your mowing pattern to avoid discharge of material toward roads, sidewalks, bystanders and the like. Also, avoid discharging material against walls or obstructions, which may cause discharged material to ricochet back toward the operator.
- 7.** To help avoid blade contact or an injury from thrown objects, stay in the operator zone behind the handles and keep children, bystanders, helpers and pets at least 100 feet (30m) away from the mower while it is in operation. Stop the machine if anyone enters the area.
- 8.** Always wear safety glasses or safety goggles during operation and while performing an adjustment or repair to protect your eyes. Thrown objects that ricochet can cause serious injury to the eyes. Always use a face or dust mask if the operation is dusty.
- 9.** Do not put hands or feet near rotating parts or under the cutting deck. Contact with the blade can amputate hands and feet.
- 10.** A missing or damaged discharge cover can cause blade contact or injuries from thrown objects.
- 11.** Many injuries occur as a result of the mower being pulled over the foot during a fall caused by slipping or tripping. Do not hold onto the mower if you are falling; immediately release the handle.

- 12.** Never pull the mower back toward you while you are walking. If you must back the mower away from a wall or obstruction, first look down and behind you to avoid tripping, and then follow these steps:
 - Step back from mower to fully extend your arms.
 - Be sure you are well balanced with sure footing.
 - Pull the mower back slowly, no more than half way toward you.
 - Repeat these steps as needed.
- 13.** The motor/blade control handle is a safety device. Never attempt to bypass its operation. Doing so makes the safety device inoperative and may result in personal injury through contact with the rotating blade. The motor/blade control handle must operate easily in both directions and automatically return to the disengaged position when released.
- 14.** Always be sure of your footing. A slip and fall can cause serious personal injury. If you feel you are losing your footing, release the motor/blade control handle immediately and the blade will stop rotating within three seconds.
- 15.** Mow only in daylight or good artificial light. Walk, never run while operating.
- 16.** Stop the blade when crossing gravel drives, walks or roads.
- 17.** If the equipment should start to vibrate abnormally, immediately stop the motor, remove the battery and check for the cause. Vibration is generally a warning of trouble.
- 18.** Before cleaning the machine, unclogging the chute or removing or replacing the grass bag, mulching insert, or side discharge chute, turn the motor off and wait until the blade comes to a complete stop, then remove the battery pack. The cutting blade continues to rotate for a few seconds after the motor is shut off.
- 19.** Never place any part of the body in the blade area until you are sure the blade has stopped rotating.
Never operate the mower without the proper trailing shield, discharge cover, grass bag, mulching insert, side discharge chute, motor/blade control handle or other safety protective devices in place and working. Never operate the mower with damaged safety devices. Failure to do so can result in personal injury.
- 20.** If the mower's built-in overload protection switch frequently trips, contact Litheli Customer Service.
- 21.** Do not wash the mower with a hose; avoid getting water in the motor and electrical connections.

- 22.** Remove the battery and store the idle lawn mower in a covered area when not in use. Allow the motor to cool before storing it in any enclosure. The lawn mower should be stored in a dry, high, or locked-up enclosure, out of reach of children.
- 23.** When servicing, use only identical replacement parts listed in this manual. Use of parts that do not meet the original equipment specifications may lead to improper performance and compromised safety.
- 24.** To reduce a fire hazard, keep the motor cover free of grass, leaves and debris build-up.
- 25.** Check the blade and motor mounting bolts at frequent intervals for proper tightness. Also, visually inspect the blade for damage (e.g., bending, cracking and wear.). Replace the blade only with the identical replacement blade, as listed in this manual.
- 26.** Keep all nuts, bolts, and screws tight to be sure the equipment is in safe working condition.
- 27.** Never remove or tamper with safety devices. Regularly check their proper operation. Never do anything to interfere with the intended function of a safety device or to reduce the protection provided by a safety device.
- 28.** Always stop the motor before making adjustments to a wheel or a cutting-height adjustment.
- 29.** After striking a foreign object, stop the motor, remove the battery pack, allow the blade to stop rotating, and thoroughly inspect the mower for any damage. Repair the damage before operating the mower.
- 30.** Maintain or replace safety and instruction labels, as necessary.
- 31.** If situations occur that are not covered in this manual, use care and good judgment. Contact the Litheli Customer Service for assistance.

SAFETY WARNINGS FOR BATTERY PACK

- 1.** Do not modify or attempt to repair the battery pack. Do not dismantle, open or shred battery pack.
- 2.** Do not expose a battery pack or appliance to fire or excessive temperature. Exposure to fire or temperature above 265°F (130°C) may cause explosion.

- 3.** Do not short-circuit a battery pack. Do not store battery packs haphazardly in a box or drawer where they may short-circuit each other or be short-circuited by other metal objects. When battery pack is not in use, keep it away from other metal objects, like paper clips, coins, keys, nails, screws or other small metal objects, that can make a connection from one terminal to another. Shorting the battery terminals together may cause burns or fire.
- 4.** Do not subject battery pack to mechanical shock.
- 5.** Observe the plus (+) and minus (-) marks on the battery back and equipment and ensure correct use.
- 6.** Keep battery pack out of the reach of children.
- 7.** Always purchase the battery pack recommended by the device manufacturer for the equipment.
- 8.** Keep battery pack clean and dry.
- 9.** Wipe the battery pack terminals with a clean dry cloth if they become dirty.
- 10.** Battery pack need to be charged before use. Always use the correct charger and refer to the manufacturer's instructions or equipment manual for proper charging instructions.
- 11.** Do not leave battery pack on prolonged charge when not in use.
- 12.** After extended periods of storage, it may be necessary to charge and discharge the battery pack several times to obtain maximum performance.
- 13.** Battery pack gives its best performance when it is operated at normal room temperature (20°C—35°C).
- 14.** Use only the battery pack in the application for which it was intended. Do not use a battery pack or appliance that is damaged or modified. Damaged or modified batteries may exhibit unpredictable behavior resulting in fire, explosion or risk of injury.
- 15.** Remove the battery pack from the equipment when not in use.
- 16.** Dispose of properly.
- 17.** Do not handle the charger, including charger plug, or charger terminals with wet hands.
- 18.** Do not charge the battery pack outdoors, in rain, or in wet locations.
- 19.** Recharge only with the charger specified by the manufacturer. A charger that is suitable for one type of battery pack may create a risk of fire when used with another battery pack.
- 20.** Use power tools only with specifically designated battery packs. Use of any other battery packs may create a risk of injury and fire.



21. Under abusive conditions, liquid may be ejected from the battery; avoid contact. If contact accidentally occurs, flush with water. If liquid contacts eyes, additionally seek medical help. Liquid ejected from the battery may cause irritation or burns.

Save these instructions. Refer to them frequently and use them to instruct others who may use this tool. If you lend this tool to someone else, also lend these instructions to them to prevent misuse of the product and possible injury.









Safety Symbols





The purpose of safety symbols is to attract your attention to possible danger. The safety symbols and the explanations with them deserve your careful attention and understanding. The symbol warnings do not, by themselves, eliminate any danger. The instruction and warnings they give are no substitutes for proper accident prevention measures.

The following signal words and meanings are intended to explain the levels of risk associated with this product.

SYMBOL	SIGNAL	MEANING
	DANGER	Indicates a hazardous situation, which, if not avoided, will result in death or serious injury.
	WARNING	Indicates a hazardous situation, which, if not avoided, could result in death or serious injury.
	CAUTION	Indicates a hazardous situation, which, if not avoided, may result in death or serious injury.
	NOTICE	(Without Safety Alert Symbol) Indicates information considered important, but not related to a potential injury (e.g. messages relating to property damage).

Some of the following symbols may be used on this product. Please study them and learn their meaning. Proper interpretation of these symbols will allow you to operate the product better and safer.

	<p>Read Operator's Manual</p>	<p>To reduce the risk of injury, user must read and understand the operator's manual before using this product.</p>
	<p>Wear Eye Protection</p>	<p>Always wear safety goggles or safety glasses with side shields and a full face shield when operating this product.</p>
	<p>Maintain Safety Devices</p>	<p>Do not open or remove safety shields while the tool is running.</p>
	<p>Look Behind While Backing</p>	<p>Look down and behind first to avoid tripping when pulling back.</p>
	<p>DANGER!</p>	<p>DANGER! Rotating blades. Keep hands and feet away.</p>
	<p>No Reach</p>	<p>Do not reach hands or feet under mower deck. To reduce the risk of injury, do not operate unless discharge cover or grass bag is in its proper place. If damaged, replace immediately.</p>
	<p>DANGER Keep Bystanders Away</p>	<p>Do not mow when children or others are nearby.</p>
	<p>DANGER Thrown Debris</p>	<p>Remove objects that can be thrown by the blade in any direction. Wear safety glasses.</p>

	DANGER Steep Slope Hazard	
	Blade Keeps Running.	Blade continues to rotate after machine is switched off.
	Remove Battery Pack and Safety Key.	WARNING! Always turn the machine OFF and remove the batteries and safety key before conducting inspection, cleaning and maintenance.
	Wet Condi- tions Alert	WARNING! Do not expose the unit to rain or wet conditions.
	Recycle Symbol	This product uses lithium-ion (Li-ion) batteries. Local, state, or federal laws may prohibit disposal of batteries in ordinary trash. Consult your local waste authority for information regarding available recycling and/or disposal options.

Know Your Tool

1. Push Handlebar
2. On/Off Trigger
3. Lock Off Button
4. Electrical Cable
5. Upper Handlebar
6. Lower Handlebar
7. Rear Discharge Cover
8. Quick-Assembly Set
9. Height Adjustment Lever
10. Cable Clamp
11. Grass Bag
12. Mower Deck

- 13. Rear Wheel
- 14. Carrying Handle
- 15. Front Wheel
- 16. Battery Compartment Cover
- 17. Battery Pack Release
- 18. Battery Power Indicator Light
- 19. Battery Power Button
- 20. Two Way Type-C Port
- 21. USB-A Port
- 22. Charging Cable

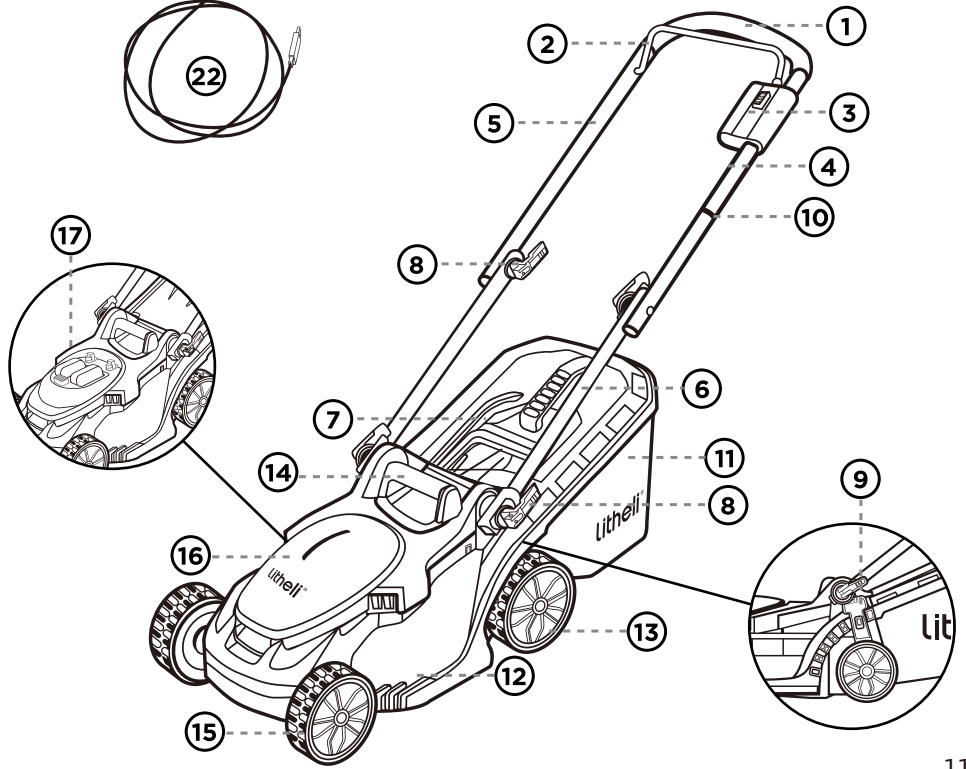
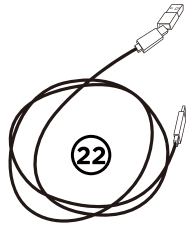
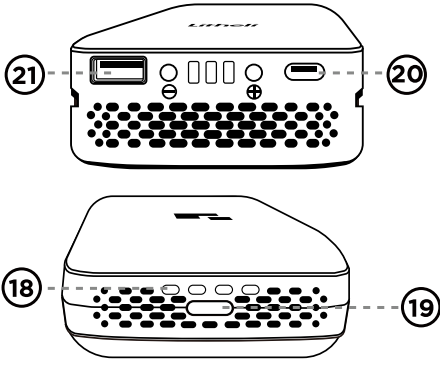

Technical Data

Model No.	U20LM00-0A120
Voltage	20V == MAX
Cutting Width	13"(330mm)
No-Load Speed	3300rpm/3700rpm±5%
Front Wheel Diameter	5.5"(140mm)
Rear Wheel Diameter	6.3"(160mm)
Cutting Height	1"-2.56"(25-65mm)
Cutting Height Positions	5
Grass Bag Volume	30L
Machine Weight (Battery Excluded)	24.2lbs (11kg)

*** Charger is not supplied with this product. You should prepare a 45W charger to work with the supplied charging cable for charging.**

ACCESSORIES

Model No.	U20LM00-0A120
Part Name	Quantity
Lawn Mower	1
Grass Bag	1
Quick-Assembly Set	4
Battery Pack	1
Operator's Manual	1

Litheli BATTERY (U-BATTERY PLUS)

NOTICE:

- Use only Litheli U-BATTERY PLUS for this appliance.
- This Litheli U-BATTERY PLUS is not resistant to water or dust. Please always keep this battery dry and clean when in use and storage. Do not allow water or moisture enter this battery.

- Benefiting from the innovative battery replacement design, the battery can be exchanged easily.
- Short charging time, and minimal heating while charging.
- The same lithium-ion electrochemistry which is for new energy vehicles.
- Can work as power bank and charge mobile phones and laptops.

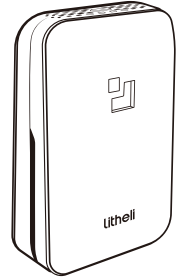

Charging Your Battery

⚠ WARNING:

Do not use charger outdoors or expose it to wet or damp conditions. Water entering the charger will increase the risk of electric shock.

⚠ WARNING:

Charge the battery in a dry and ventilated room, far away from combustibles and ignition sources.

NOTICE: Charger is not supplied with this appliance. You should prepare a 45w charger to work with the supplied charging cable for charging. Make sure the charger meets the requirement (Max. Charging Input) in Technical Data.

NOTICE: Lithium-ion batteries are shipped partially charged. Before using it the first time, fully charge the battery.

BATTERY POWER INDICATOR

The battery supplied with this appliance is equipped with 4 battery power indicator lights which indicate the charge remained in the battery. Press the battery power button to check the remaining power.

The power level will be shown as following when charging:

- a. When only one indicator shows flashing, the battery needs to be charged.
- b. During the charging process, the indicators will light up one by one according to the charging situation, the indicator corresponding to the part that is full is always on, and the indicator of the part that is not fully charged flashes.
- c. All 4 indicator lights light up when the battery is fully charged.

NOTICE: If the battery power indicator lights 1&2 flash, it indicates an abnormal voltage or temperature situation.

Power Level	LED1	LED2	LED3	LED4
0-25%	Flashing	Off	Off	Off
25-50%	On	Flashing	Flashing	Flashing
50-75%	On	On	Flashing	Flashing
75-99%	On	On	On	Flashing
Fully Charged	On	On	On	On
Error	Flashing	Flashing	Off	Off

CHARGING PROCEDURE:

- a. Remove the battery from the appliance.
- b. Use the supplied charging cable, insert the Type-C male connector at one end into the Two Way Type-C Port at the bottom of the battery.

- c. Connect the other end of the charging cable to the charger (not supplied), and connect the charger to the power supply for charging. Running light shows current battery level when charging.
- d. When all the battery power indicator lights stay on, the battery are fully charged. Remove the battery from the charger and disconnect them from the charging cable.

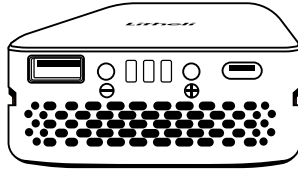

TIPS:

- a. The battery is not fully charged when leaving the factory, so be sure to fully charge the battery before first use.
- b. Do not charge the battery at temperatures below 5°C or above 40°C.
- c. When the working time of this appliance becomes significantly shorter, or the charging time becomes longer, it is recommended to replace the battery for a new one.
- d. The battery features overcharge protection, over-discharge protection and short circuit protection.
- e. The battery features overheating protection, and the output voltage for charging/powering devices which is operated in conformity with the instructions in this Manual is within a safe range, ensuring the safety for users.

To avoid accidents, do not disassemble or modify the machine or the battery.

Assembly and Adjustment

WARNING:

To prevent accidental starting that could cause serious personal injury, always remove the battery pack from the tool when assembling parts.

⚠ WARNING:

Do not attempt to modify this tool or create accessories not recommended for use with this mower. Any such alteration or modification is misuse and could result in a hazardous condition leading to serious injury.

UNPACKING

- This product requires assembly.
- First remove all the accessories from the carton, then grasp both the front part of the deck cover and the rear handle at the same time to carefully lift the mower up and out of the carton. Make sure that all items listed in the parts list are included.
- Inspect the product carefully to make sure that no breakage or damage occurred during shipping.
- Do not discard the packing material until you have carefully inspected and satisfactorily operated the mower.
- If any parts are damaged or missing, please contact Litheli Customer Service.

HANDLE ASSEMBLY

⚠ WARNING:

Do not attempt to start the mower until the handle has been locked at one of the three preset operating positions.

- a. The unit arrives with the lower handle in the storage position and the upper handle detached.
- b. Lift the lower handle to the fixed height and tighten the Quick-Assembly Set. (Fig. 1).

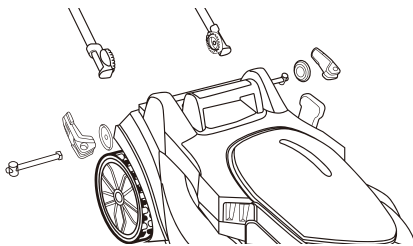

Fig. 1

- c. Fit the upper handle onto the lower handle. Insert the provided bolts into the aligned holes on the handles and secure the knobs onto the bolts (Fig. 2).

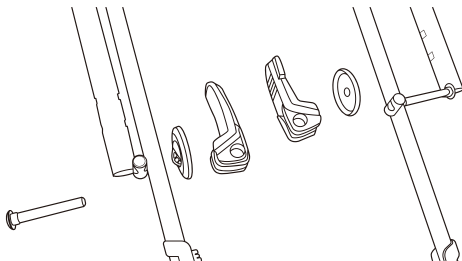

Fig. 2

ATTACHING/REMOVING THE GRASS BAG (Fig. 3 & 4)

⚠ WARNING:

Do not at any time make any adjustment to the lawn mower without first stopping the motor, removing the battery pack and waiting for the blade to stop rotating.

- a. Lift the rear discharge cover up and hold it.
- b. With the rear discharge cover lifted up, hold the grass collection bag by the handle and hook it in from above onto the hooks on both sides.

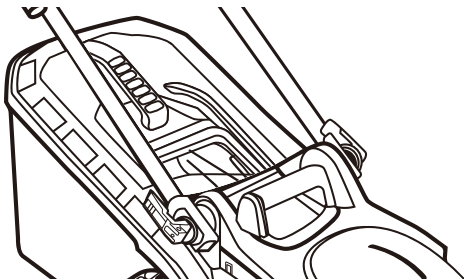

Fig. 3

- c. Release the rear discharge cover so that it rests on the grass bag.
- d. To remove the grass bag, lift the rear-discharge cover on the mower. Lift the grass bag up, off of the hooks on both sides.
- e. Release the discharge cover.

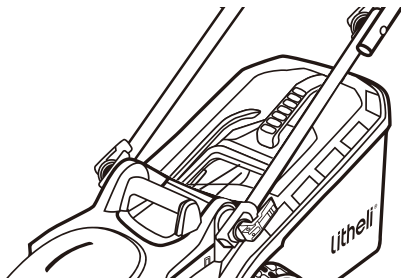

Fig. 4

⚠ WARNING:
When using the grass bag, never start or operate the mower unless the grass bag has been firmly hooked and secured onto the mower and the rear discharge cover rests snugly on the top of the grass bag.

⚠ WARNING:
Under normal usage, bag material is subject to wear. To reduce the risk of injury, frequently inspect the bag assembly and replace if there are any signs of wear or deterioration. Use grass bags manufactured only for this mower.

Operation

⚠ WARNING:
Do not allow familiarity with this product to make you careless. Remember that a careless fraction of a second is sufficient to inflict serious injury.

⚠ WARNING:
Always wear eye protection with side shields marked to comply with ANSI Z87.1, along with hearing protection. Failure to do so could result in objects being thrown into your eyes and other possible serious injuries.

⚠ WARNING:

Do not use any attachments or accessories not recommended by the manufacturer of this product. The use of attachments or accessories not recommended can result in serious personal injury.

ADJUSTING THE CUTTING-HEIGHT (Fig. 5)

⚠ WARNING:

Do not at any time make any adjustment to the lawn mower without first stopping the motor, removing the battery pack and waiting for the blade to stop rotating.

⚠ WARNING:

Keep your feet away from the deck when adjusting its height.

The mower can be set to 5 cutting heights between 1" (25mm) and 2.56" (65mm). Choose the proper cutting height according to the type and condition of the grass.

- a. Use one hand to hold the left handle tube for stability, and use the other hand to move the height adjustment lever outwards from the slots in the height indication plate.
- b. Move the cutting-height adjustment lever toward the back of the mower for a higher cutting height; move it toward the front of the mower for a lower cutting height.
- c. Once arriving at the desired height position, engage the cutting-height adjustment lever back into the slot.

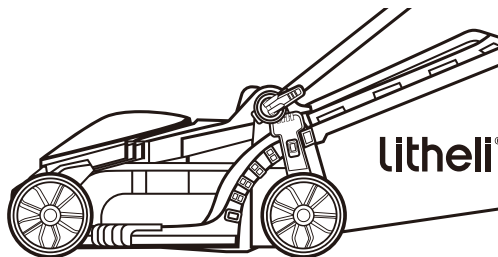

Fig. 5

TO INSTALL/REMOVE BATTERY PACK (Fig. 6)

NOTICE: CHARGE BEFORE FIRST USE.

⚠ WARNING:

If any parts are broken or missing, do not attempt to attach the battery pack to the mower or operate the mower until the broken or missing parts are replaced. Failure to do so could result in serious injury.

- a. The battery cover is hinged. Raise the battery cover by lifting the front of the cover.
- b. Align the grooves in the battery packs, with the raised ribs in the battery compartment, and then insert the battery packs into the compartment.
- c. Push the battery packs downwards until you hear a “click”. The battery release button will spring up when the battery packs are securely attached.
- d. To detach the battery packs, depress the battery-release button, then lift them out of the compartment.
- e. Close the battery cover.

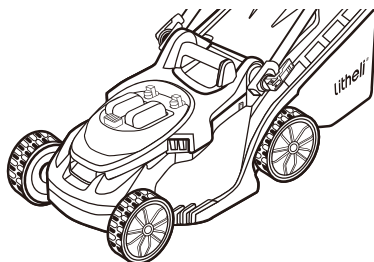

Fig. 6

STARTING/STOPPING THE LAWN MOWER

⚠ WARNING:

The operation of any lawn mower can result in foreign objects being thrown into your or others' eyes, which can damage eyes severely. Always wear safety glasses while operating the mower or while performing any adjustments or repairs on the mower.

⚠ WARNING:

Ensure that other people and pets remain at least 100' (30m) away from the mower when it is in use.

⚠ WARNING:

The blade will continue to rotate for a few seconds after the mower is turned off. Allow the motor/blade to stop rotating before starting it again. Do not rapidly turn the mower off and on.

⚠ WARNING:

Do not attempt to override the operation of the lock off button and the On/Off trigger.

TO START THE MOWER (Fig. 7)

a. Attach the battery pack to the mower and close the battery cover.

NOTICE: Make sure that the latch on the mower snaps into place and that the battery packs are secured to the mower before operation.

b. Depress the lock off button.

c. With the lock off button depressed, pull the bail switch upward to meet the handle and release the lock off button.

d. The mower will start.

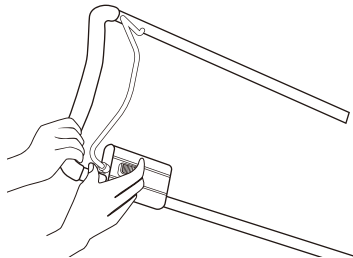

Fig. 7

TO STOP THE MOWER (Fig. 8)

a. Fully release On/Off trigger.

b. The electric brake in the Automatic Braking Mechanism will stop the blade rotation within 3 seconds after the On/Off trigger is released.

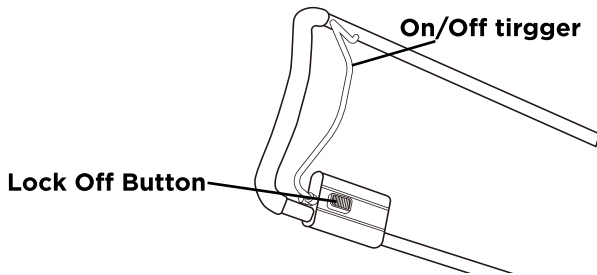

Fig. 8

MOWER OVERLOAD PROTECTION

To prevent overload conditions, do not try to remove too much grass at one time. Slow down your cutting pace or raise the cut height.

Your mower has built-in overload circuit protection. When the mower is overloaded, the motor will stop and the power indicator on the mower will flash orange. Remove the battery pack from the mower. Check to see if grass has collected beneath the deck and clear it if necessary, then install the battery and restart the mower.

MOWING TIPS

NOTICE: A sharp blade will greatly enhance the performance of the mower, especially when cutting tall grass. Make sure to check the sharpness of the blade before mowing.

- Verify that the lawn is free of stones, sticks, wires, and other objects which could damage the lawn mower or motor. Such objects could be accidentally thrown by the mower in any direction and could cause serious personal injury to the operator and to others.

⚠ WARNING:

If you strike a foreign object, stop the motor and remove the battery. Thoroughly inspect the mower for any damage, and repair the damage before restarting and operating the mower. Excessive vibration of the mower during operation is an indication of damage. The unit should be promptly inspected and repaired.

- For best results, do not mow in circles. Travel back and forth across the lawn.
- When cutting thick grass, reduce your walking speed in order to allow for a more effective cut and a proper discharge of the clippings.
- To maintain a healthy lawn, cut off only one-third or less of the total length of the grass.
- The average lawn should be approximately 1-1/2 to 2 inches long during cool months, and between 2 to 3-1/4 inches long during hot months.

KEEP CHILDREN AWAY

Tragic accidents can occur if the operator is not alert to the presence of children. Children are often attracted to the mower and mowing activity. They do not understand the dangers. Never assume that children will remain where you last saw them.

- Keep children out of the mowing area and under the watchful care of a responsible adult other than the operator.
- Be alert and turn the mower off if a child enters the area.
- Use extreme care when approaching blind corners, doorways, shrubs, trees, or other objects that may obscure your vision of a child who may run into the mower.
- Never allow children under 14 years old to operate a power mower. Children 14 years old and over should read and understand the operation instructions and safety rules in this manual and should be trained and supervised by a parent. Only responsible individuals who are familiar with these rules of safe operation should be allowed to use this machine.

MOWING ON SLOPE

Slopes are a major factor related to slip-and-fall accidents, which can result in severe injury. Operation on slopes requires extra caution. If you feel uneasy on a slope, do not mow it. For your safety, use the slope gauge (Fig. 9) to measure slopes before operating this unit on a sloped or hilly area. If the slope is greater than 15 degrees, do not mow it.

Do:

- Mow across the face of slopes; never mow up and down. Exercise extreme caution when changing direction on slopes.
- Watch for holes, ruts, rocks, hidden objects, or bumps which can cause you to slip or trip. Tall grass can hide obstacles.

Do not:

- Do not mow near drop-offs, ditches or embankments; you could lose your footing or balance.
- Do not mow slopes greater than 15 degrees (a rise of approximately 2-1/2' (0.75m) every 10' (3m)), as shown on the slope gauge.
- Do not mow on wet grass. Unstable footing could cause slipping.

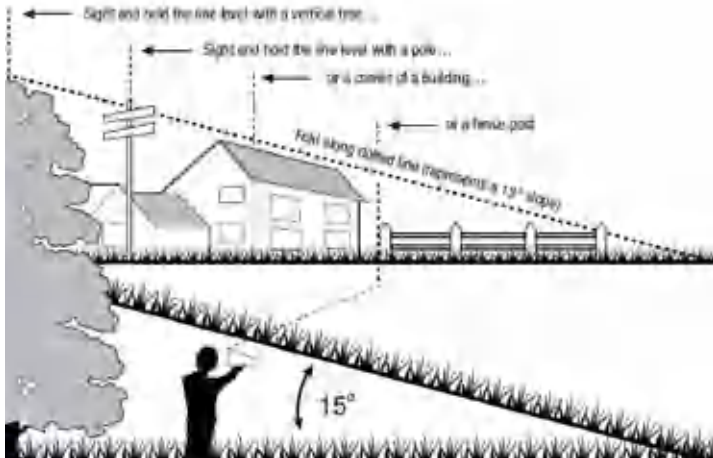

Fig. 9

Maintenance

⚠ WARNING:

When servicing, use only identical replacement parts. Use of any other parts may create a hazard or cause product damage. To ensure safety and reliability, all repairs should be performed by a qualified service technician.

⚠ WARNING:

To prevent serious personal injury, remove the battery pack from the tool before servicing, cleaning, changing add-on attachments or removing material from the unit.

CLEANING THE MOWER

WARNING: Always remove the battery pack when servicing or transporting the mower.

- The underside of mower deck should be cleaned after each use, as grass clippings, leaves, dirt and other debris will accumulate.
- Wipe the mower clean with a damp cloth.

BLADE REPLACEMENT

⚠ WARNING:

Always protect your hands by wearing heavy gloves or wrapping the cutting edges with rags or other materials when performing any maintenance on the mower blade. Always remove the battery pack when servicing or transporting the mower.

- Remove the batteries from the mower.
- Turn the mower on its side to expose the underside of the blade housing.
- Use a cloth to grip the blade or wear heavy-duty gloves.
- Using a 16mm lug wrench (not provided), remove the lug nut securing the blade by turning the lug nut counter-clockwise, then carefully remove the blade (Fig. 10 & 11).

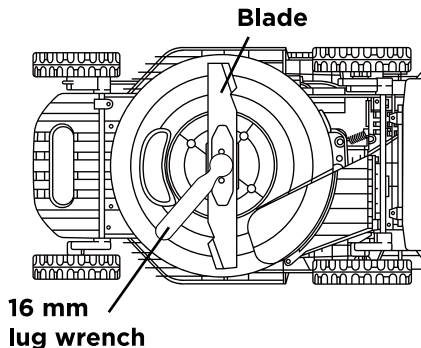

Fig. 10

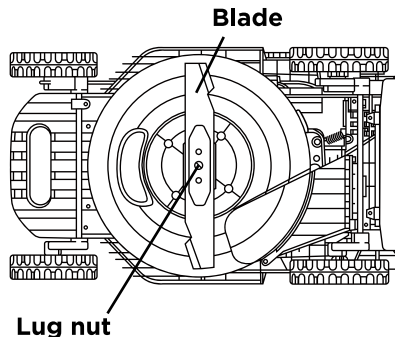

Fig. 11

- e. Fit the new blade on the same position and secure with the original lug nut (Fig. 12)

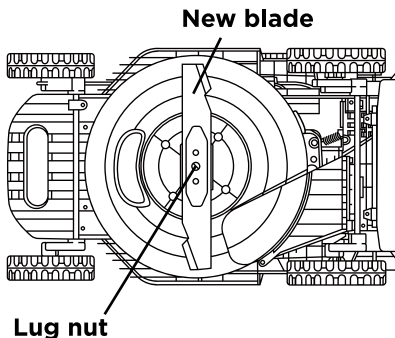

Fig. 12

SHARPENING THE BLADE

WARNING:

Always protect your hands by wearing heavy gloves or wrapping the cutting edges with rags or other materials when performing any maintenance on the mower blade. Always remove the battery pack when servicing or transporting the mower.

WARNING:

Use proper eye protection while removing, sharpening, and installing the blade.

WARNING:

A worn, cracked, or damaged blade can break and pieces of the damaged blade can become dangerous projectiles. Thrown objects can cause serious injury. Inspect the blade regularly and do not operate the mower with a worn or damaged blade.

NOTICE: Keep the blade sharp for best mower performance. A dull blade does not cut grass cleanly or mulch properly.

A dull blade can be sharpened, but a blade that is excessively worn, bent, cracked, or otherwise damaged must be replaced. A worn or damaged blade can break, causing blade pieces to be thrown from the mower.

SHARPENING THE BLADE

Sharpening the blade twice during a mowing season is usually sufficient under normal circumstances. Sand causes the blade to dull quickly; if your lawn has sandy soil, more frequent sharpening may be required.

When Sharpening The Blade:

- Make sure that the blade remains balanced.
- Sharpen the blade at the original cutting angle.
Sharpen the cutting edges on both ends of the blade, removing an equal amount of material from each end.

To Sharpen Blade In A Vise:

- a. Remove the blade from the mower (please see **BLADE REPLACEMENT**).
- b. Secure the blade in a vise (Fig. 13).

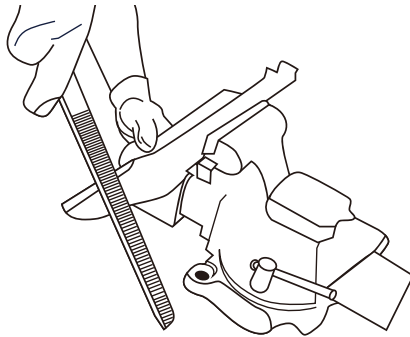

Fig. 13

- c. Wear proper eye protection and gloves and be careful not to cut yourself.
- d. Carefully file the cutting edges of the blade with a fine tooth file or sharpening stone, maintaining the original cutting edge angle.
- e. To check the blade balance: clamp a nail or a screw driver with a round shank in the horizontal position. Position the blade so that the nail or round shank of the screwdriver supports the blade through its center hole. Balance the blade horizontally. If either end of the blade rotates downward, remove some metal from the heavy or lower end until the blade is balanced. It is balanced when neither end drops.
- f. Replace the blade on the mower and tighten it securely (please see **BLADE REPLACEMENT**).

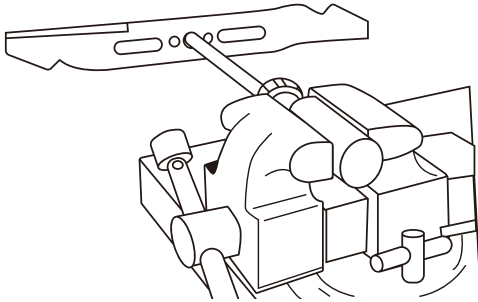

Fig. 14

⚠ WARNING:

An unbalanced blade will cause excessive vibration when rotating at high speeds. It may cause damage to the mower and could break, causing personal injury.

LUBRICATION

⚠ WARNING:

Remove the battery pack before any lubrication work. It is recommended to have this machine lubricated by qualified engineer or authorized service center.

REPLACING THE WHEELS

⚠ WARNING:

Always remove the battery pack when servicing or transporting the mower.

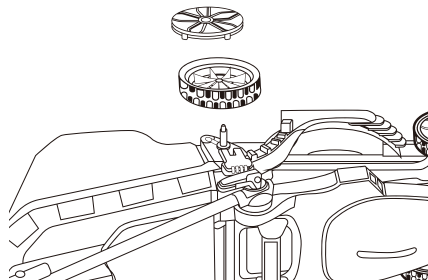

Fig. 15

- a. Turn the mower on its side with the upper surface against a wall.
- b. Use an adjustable or 1/2”(13mm) wrench to turn the nut counter-clockwise to loosen it.
- c. Remove the nut, the worn wheel from the wheel axle.
- d. Mount the new wheel on the wheel axle. Note that the round recess must face outward.
- e. Lock the wheel with the nut by tightening the nut clockwise.
- f. Mount the dust cover onto the wheel and press it in place.

STORING THE MOWER

The following steps should be taken in order to prepare the lawn mower for storage.

- a. Remove the batteries from the battery compartment.
- b. Remove the grass collection bag. Engage the height adjustment lever in the lowest cutting height slot.
- c. Clean the mower with a damp cloth or hand brush.
- d. Inspect the mower carefully for worn, loose or damaged parts. Check connections and screws and tighten if necessary. Pay special attention to the mower blade and replace/sharpen if it shows signs of wear. Refer to the Maintenance and Care section.
- e. Store the mower indoors in a dry, clean and cool area out of the reach of children. Do not store the unit next to corrosive materials such as fertilizer and rock salt.
- f. Do not cover the lawn mower with a solid plastic sheet. Plastic coverings trap moisture around the mower, which can damage the unit.
- g. The handle on your lawn mower can be completely folded for compact storage. Start by loosening all of the handle knobs of the upper handle and fold down the upper handle. Then lower the lower handle completely (Fig. 16).

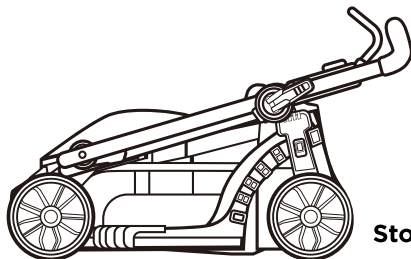

Storage position

Fig. 16

STOPPING THE BATTERY PACK

- a.** Protect the battery against moisture and water.
- b.** Store the battery only within a temperature range from 41°F (5°C) to 104°F (40°C). As an example, do not leave the battery in a vehicle or in the mower in direct sunlight.
- c.** Clean the ventilation slots of the battery occasionally with a soft, clean and dry brush. A considerably shortened operating time after charging is an indication that the battery is exhausted and must be replaced.
- d.** If you do not use the product for a long time please charge and discharge the battery pack once every 6 months.

Troubleshooting

⚠ WARNING:

Always remove the battery pack when servicing or transporting the mower. Always protect your hands by wearing heavy gloves or wrapping the cutting edges with rags or other materials when performing any maintenance on the mower blade.

Problem	Possible causes	Solution
The mower fails to start.	The battery pack is depleted.	Charge the battery pack.
	The battery pack is not mounted in place in the battery compartment.	Make sure the battery pack is engaged.

The mower fails to start.	The battery or mower circuitry is too hot.	Allow the battery pack or mower to cool until the temperature drops below 152°F (67°C).
	The mower deck is clogged with grass and debris.	Clean the mower deck and make certain that the blade has freedom of movement.
	Other reasons.	Contact Customer Service.
The mower cuts unevenly.	The blade is dull.	Sharpen or replace the blade.
	The cutting height is not set properly.	Adjust the deck height to a higher setting.
	The blade is assembled incorrectly.	Reassemble the blade, following the section “BLADE REPLACEMENT” in this manual.
The mower stops while mowing.	Mower is in overload condition.	Raise the cutting height or slow down the mowing.
	Mower deck is clogged with grass and debris.	Unclog the mower deck. Make sure there is no disturbing objects on the grass to be mowed.
	The battery or mower circuitry is too hot.	Allow the battery pack or mower to cool until the temperature drops below 152°F (67°C).
There is excessive vibration.	The cutting blade is loose.	Tighten the blade bolt.
	The cutting blade is unbalanced.	Balance the blade following the instructions.
	The cutting blade is bent.	Replace the blade.

The motor works but the blade doesn't cut the grass.	The blade is not tightened to the required torque.	Re-tighten the blade. The recommended torque for the blade bolt is 36-43 ft-lb (49-59Nm).
Short running time of the mower with the included battery.	Grass conditions and cutting height setting will greatly affect the battery run time. The claimed run time is based on a light load condition.	Raise the blade height and slow your pace to reduce the cutting load.

Warranty

Litheli WARRANTY POLICY FOR U20 PRODUCT

- For Litheli U20 product (battery excluded) used for personal and household purposes, 3-year limited standard warranty + 2-year limited extended warranty available upon product registration;
- For Litheli U20 batteries used for personal and household purposes, 3-year limited warranty;

NOTICE: Litheli offers a Warranty Extension Service for U20 product (battery excluded). Litheli U20 product (battery excluded) Warranty Extension is available only upon product registration. Register your U20 product on Litheli OFFICIAL website to activate a 2-year limited extended warranty.

Please contact Litheli customer service at service@litheli.com any time you have questions or warranty claims.

LIMITED WARRANTY SERVICE

FOR FIVE (2-year limited extended warranty included) YEARS from the date of original retail purchase, this Litheli product (battery not included) is warranted against defects in material or workmanship. Defective product will receive free repair or will be exchanged.

FOR THREE YEARS from the date of original retail purchase, the Litheli battery is warranted against defects in material or workmanship. Defective product will receive free repair or be exchanged.

1. This warranty only covers Litheli products and batteries used for residential purposes.
2. This warranty does not cover the consumables such as, but not limited to, charging cable, plastic blades.
3. This warranty does not cover the damage resulting from modification, alteration or unauthorized repair.
4. This warranty only covers defects arising under normal usage and does not cover any malfunction, failure or defect resulting from misuse, abuse (including overloading of the product beyond capacity and immersion in water or other liquid), accidents, neglect or lack of proper installation, and improper maintenance or storage.
5. This warranty does not cover normal deterioration of the exterior finish including but not limited to scratches, dents, paint chips, or to any corrosion or discoloring by heat, abrasive and chemical cleaners.
6. This warranty applies only to the original purchaser from an authorized Litheli shop and may not be transferred.
7. This warranty does not require Litheli to repair or replace a Litheli lithium-ion battery/ies if the battery/ies present/s shortened runtime/working hour, reduced capacity, and/or weakened performance due to normal chemical age.

WARRANTY CLAIM

Please register your Litheli product on [Litheli OFFICIAL website](#).

For better warranty services, we recommend that you register the product within 30 days from the date of the original retail purchase.

PRODUCT REGISTRATION

For warranty claims, please contact Litheli customer service. You will need to submit a registration document or proof of purchase in the form of a valid receipt that displays date and place of purchase. Replacement products do not come with a new warranty. The warranty of the products will continue from the date of the original purchase.

litheli tool

TOOLS FOR THE FUTURE



+1 (800) 323-8991



www.Litheli.com



service@litheli.com