

F7NP USER MANUAL

Email: help@redtigerscam.com

Website: <http://www.redtigerscam.com>

Phone: +188 8966 8028

 Instagram



WARNING: Be careful when using your camera and its accessories. Always be cautious of your surroundings to avoid injuring yourself and others.

Make sure to follow all local laws including all privacy laws which may restrict recording in certain areas.

IC warning:

This device contains licence-exempt transmitter(s)/receiver(s)/ that comply with Innovation Science and Economic Development Canada's licence-exempt RSS(s). Operation is subject to the following two conditions:

1. This device not cause interference.
2. This device must accept any interference, including interference that may cause undesired operation of the device.

Radiation Exposure: This equipment complies with Canada radiation exposure limits set forth for an uncontrolled environment. To maintain compliance with IC's RF Exposure guidelines, this equipment should be installed and operated with minimum distance of 20cm the radiator your body. This device and its antenna(s) must not be co-located or operation in conjunction with any other antenna or transmitter.

Contents

What's in box?	02
Meet your F7NP	03
Button Function	05
F7NP Power Tools	06
Install Your Dash Cam	07
Setting Up Your Camera	11
Playing Back Your Media	14
Customizing Your F7NP	16
Parking Mode (Optional)	20
Connect to the Redtiger App	25
Redtiger Player	30
Maintenance	32
Trouble Shooting	33
Customer Service	36
Product Information	38

What's in box?



1* F7N
4K Dash Cam



1* GPS Mount



1* 1080P
Rear Camera



1* Power Supply
Cable with Car
Charger



1* Rear Camera
Cable



2* Electrostatic
Sticker



1* 32GB
MicroSD card



1* User Manual



1* 3M Adhesive



1 * Car Wire
Trim Tool



5* Cable Clips

Meeting Your F7NP

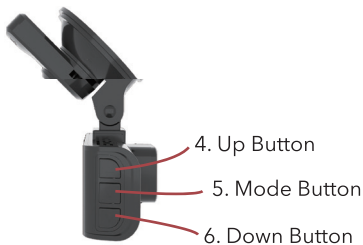

Meeting Your F7NP

9. Rear Cam Slot



10. Type-C USB Power Slot

11. Reset Button



12. Lens



Button Function

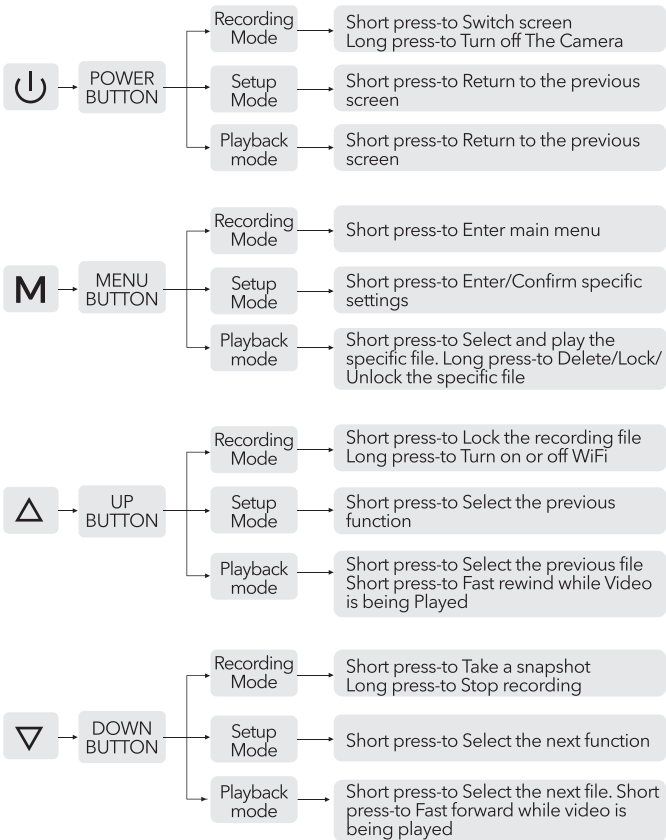

F7NP Power Tools



1. Cig Charger

Note: It is best to use the power cord that comes with our products, or our professional hardwire kit.



2. Hardwire Kit
(Required for Parking Mode.
Prevents car battery drain.)
(Not included, purchase
separately)

Install Your Dash Cam

We will guide you through the installation process step by step to ensure your dash cam is installed properly. We will prepare the installation video of F7NP dash cam for you, you can scan the QR code below to watch. Whether you are a first-time user or an experienced one, this video will provide helpful tips to make the process easy.



How to install the main body

> Start the vehicle generator, and do a bench test before officially installing the dash cam: connect the car charger to the cigarette lighter port and the dash cam, connect the rear camera and the GPS bracket, and insert the MicroSD card to ensure that the dash cam can work normally.

> Find the right spot on the front windshield. Wipe the pre-installed location with a clean cloth.

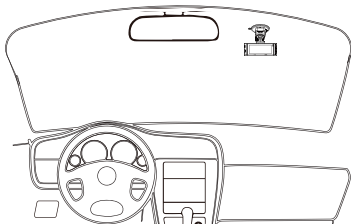

Install Your Dash Cam

> Use the suction cup to fix the F7NP dash cam on the windshield, adjust its angle to record clearer video. Then turn off the vehicle to pay attention to safety.

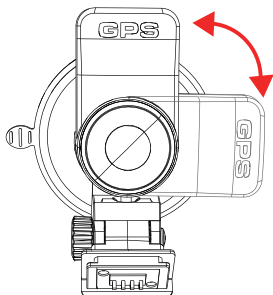

> Use the crowbar to run the power cable along the front windshield and the roof, and hide the cable on the A-pillar, so as not to block the driver's sight and cause danger.

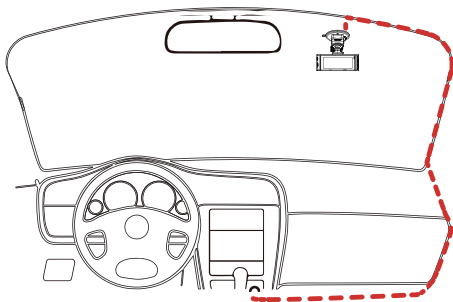

Install Your Dash Cam

How to install the in-car rear cam

NOTE: This rear camera is a special rear camera in the car, the effect is better if it is installed in the car and it is not waterproof. We recommend that you install it on the rear windshield of your car.

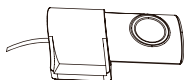

- > Use a clean cloth to wipe the rear windshield where the rear camera needs to be installed.
- > Then peel off the electrostatic sticker from the cellophane, transfer it to the place you want to stick it.

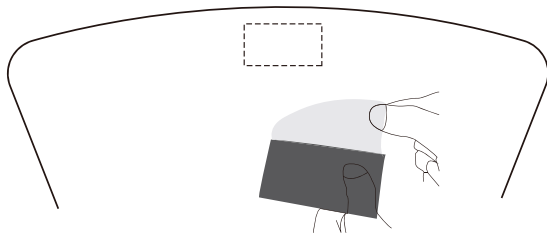

Install Your Dash Cam

> Eliminate the air bubbles on the static stickers. It is recommended to install the back camera after standing still for half an hour to make the static stickers stronger

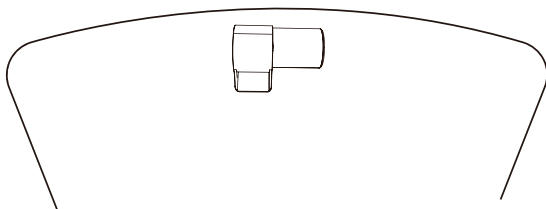

> Insert the power cord along the gaps between the front windshield and the ceiling, between the car body and the ceiling on the side of the passenger seat, and between the rear seats and the ceiling.

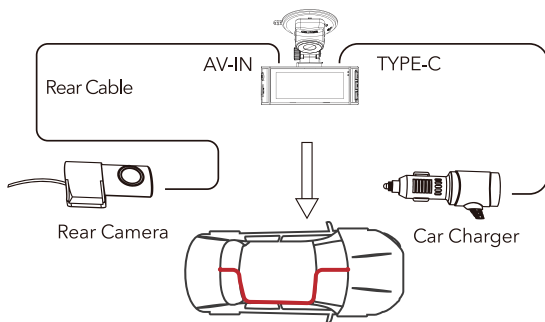

Setting Up Your Camera

MicroSD (TF) card

With your camera off, insert the card into the card slot with the label facing the back of your camera.

You can eject the card by pressing it into the slot with your fingernail.

You'll need a MicroSD card (sold separately) to save your videos and photos. Use a U3 Class 10 SD™ Card dedicated or your camera may malfunction.

MicroSD cards can degrade over time and affect your camera's ability to save your media. Try swapping out an older card for a new one if you're having any problems.

WIRING SET UP

Connect your camera to a Cig charger using the included cig charge cable.

POP-UP: Want to know what software version you're using? Here's where you can find out.

1. Press M button and enter Settings
2. Press UP button > Version

Setting Up Your Camera

POWERING ON

Short press  button to turn on your F7NP.



POWERING OFF

Press and hold  button for 3 seconds to turn it of.



POP-UP: Short press  > Front and Rear View > Front Only > Rear Only > Lock Screen > Screen Display Off

Setting Up Your Camera



Generates in 1 min/3 mins/5 mins per file



Display when fatigue driving function is on

00:00:00

Displays the recording status and recording time.

2020/12/25 11:15:29

Display the date and time of the machine

2160P+1080P

Display recording resolution



Show MicroSD card status



Display GPS status



Display voice recording status



Indicates that the rear camera is connected



G-Sensor sensitivity display



Show video recording mode



Red led blinking: Recording Video/No Red led:Not Recording Video



Power on



Emergency Video Lock



Photograph function



Enter the menu

Playing Back Your Media

CHOOSE YOUR MODE

Press M button to enter Recording > Playback > Setting. Video mode will be auto-select when power on.

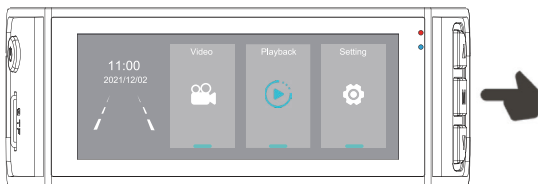

PLAY BACK

F > Front Camera

R > Rear Camera

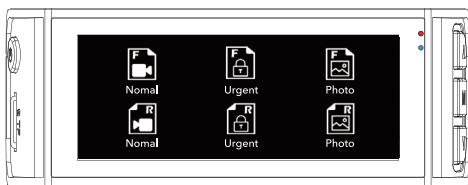

Playing Back Your Media

PLAY BACK

Short press M button to see your records.

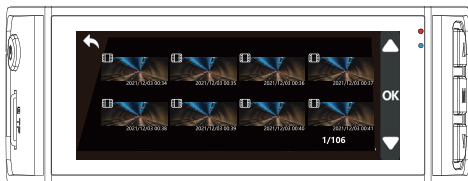

When select a record > Long press M button 3s to edit your records.



Customizing Your F7NP

SETTINGS

Short press to enter Settings menu.

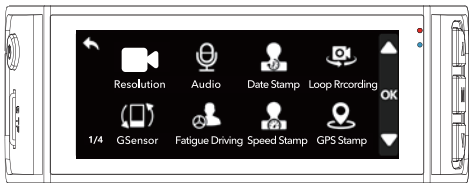

- | | |
|-----------------|---|
| Resolution | > 2160P+1080P
1440P+1080P |
| Audio | > Sound Recording ON/OFF |
| Date Stamp | > Stamp ON/OFF |
| Loop recording | > 1/3/5mins |
| G-sensor | > Off/Low/Medium/High |
| Fatigue Driving | > A Reminder Will be Made During
1h/2h/3h/4h/OFF |
| Speed Stamp | > Stamp ON/OFF |
| GPS Stamp | > Stamp ON/OFF |

Customizing Your F7NP

SETTINGS



- | | |
|---------------|-----------------------------------|
| Speed Units | > KMH/MPH |
| GPS Info | > Display GPS signal strength |
| Rear Cam Flip | > Vertical Flip Your Rear View |
| Mirror Flip | > Horizontal Flip Your Front View |
| APP | > A QR Code for Redtiger app |
| WiFi | > WiFi ON/OFF |
| Language | > Choose Your Prefer Language |
| Time Format | > 12h/24h |

Customizing Your F7NP

SETTINGS



- | | |
|-----------------|--|
| Date / Time | > Update With GPS |
| Time Zone | > Choose Your Time Zone |
| DST | > Daylight Saving Time ON/OFF |
| Frequency | > 60HZ/50HZ |
| Click Tone | > ON/OFF |
| Screen Saver | > Off/10s/30s/2mins. Screen go off after the set time. |
| Parking Mode | > Please connect the ACC hardwire kit |
| Format-Reminder | > Remind to Clear Data |

Customizing Your F7NP

SETTINGS

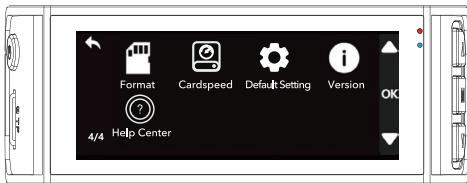

MicroSD Card Format > Clear MicroSD card data

Card-Speed > Card Speed Detection

Default Setting > Reset All Settings

Version > Software Version

Help Center > Scan the QR code to contact us

POP-UP: 1. In order to a Clean, Smooth, Comfortable using experience, we suggest you format your MicroSD card once a month.

2. If there is no GPS signal, or if the GPS has a signal but the stamp is not turned on, you will not be able to see the real-time route of the vehicle.

3. Since dash cam has a built-in GPS function, it will automatically update the time according to your location and time zone, so you don't need to change the time manually. However, you can adjust daylight saving time via DST.

4. When you turn off Click Tone, the startup and shutdown sounds will also be turned off.

Parking Mode (Optional)



PREPARE YOUR HARDWARE KIT

Hardwire Kit is needed only when using Parking Mode.

If Parking Mode is desired, contact Redtiger to purchase.

GETTING TO KNOW YOUR HARDWARE KIT

Features:

- > Low Battery Voltage Protection
- > Multi Input Power
- > Universal Compatibility
- > Length: 11.5ft



WARNING: Wrong connection may disable Voltage Protection and damage your car.

INSTALL YOU HARDWARE KIT

- | | | |
|-------------|----------|---------------------------------|
| Red wire | > ACC | > Power only when car key is on |
| Yellow wire | > B+ | > Always has power |
| Black wire | > Ground | > Any grounded (neg) screw |

Parking Mode (Optional)

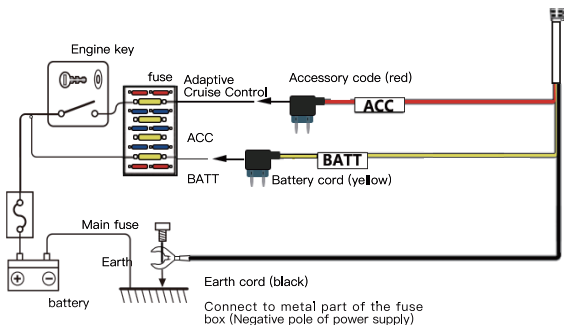

POP-UP: Fuse box panel is typically located driver side dash board. You could cut the head of wires and connect it to your fuse directly if fuses is small.

SELECT PARKING MODE

Enter Parking Mode In Settings

Setting > Parking Mode

> off/G-sensor/Time-Lapse 12 h/Time-Lapse 24h/Time-Lapse 48h

Parking Mode (Optional)

G-SENSOR

- > Car off
- > The screen prompts "ACC off, then enter GSensor mode." dash cam power off.
- > Collision or vibration be detected
- > An Unerasable record will be created in Lock space

TIME-LAPSE



















- > Select 12h/24h/48h
- > Car turn off
- > The screen prompts"ACC off, then enter timelapser rec mode."
- > The dash cam screen goes black, the red light flashes and the blue light stays on.
- > Time-lapse video is being recorded, saved in a locked folder

POP-UP: 1. 1 fps = 1 image during 1 second. G-sensor could be activated by a deceleration zone.

2. All parking surveillance videos and locked videos are placed in locked folders. If you find that the video recorded by your dash cam is choppy, it may be that it was not recording at that time or the video was put in a locked folder.

Parking Mode (Optional)

Installation Notes

Connection	Driving	Parking	
 ACC  B+  Ground	ON	Parking Mode	✓
 ACC  No connection  Ground	OFF	OFF	✗
 ACC  ACC  Ground	ON	OFF	✗
 B+  ACC  No connection	OFF	OFF	✗
 No connection  Any power  Ground	OFF	ON	✗
 B+  ACC  Ground	ON	OFF	✗

Parking Mode (Optional)

PARTICULAR WRONG CONNECTION

Connection	Driving	Parking
 B+		
 B+	ON	Always On
 Ground		

> The camera will run Parking Mode constantly, and your car battery will be drained under this connection.

> The Parking Mode will be working in screen off status. It will begin recording if there is a collision or vibration triggered by the Sensor.

> Please check if your camera working after 15mins your car is off (Because some cars have a delayed power-off function, 15 minutes later you can ensure that the ACC interface has been powered off).

FAQ:

Q1: After installing the hardwire kit, it can enter the parking monitoring mode, but it cannot be turned on with the car starting, and the dash cam needs to be turned on manually, why?

A1: Because your hardwire kit's yellow wire is connected to the wrong place.

Q2: I have installed the hardwire kit, but the dash cam still prompts that the parking monitoring mode cannot be entered, why?

A2: The first reason is that your red and yellow wires are wired incorrectly. The second reason is that the red wire of the hardwire kit is broken and there is no power.

Connect to the Redtiger App

DOWNLOAD APP

- > Download our "REDTIGER" App from:
<https://www.redtigercam.com/pages/app>
- > Scan QR Code from your F7NP
- > Download from Apple APP Store or Google Play Store



How to use the WiFi and APP: https://youtu.be/pgRJH_pf4QU



Connect to the Redtiger App

CONNECT YOUR F7NP

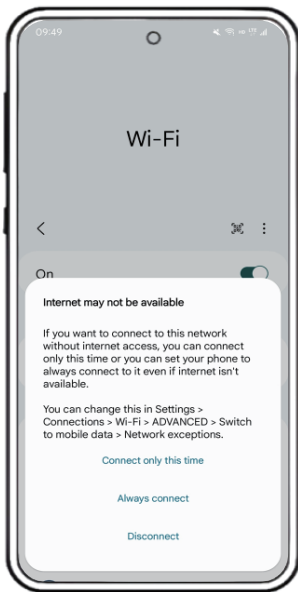

WiFi Password: 12345678

> Connect Only This Time
or Always connect

POP-UP: This is to avoid series connection between different device. Some device may prompt that the software contains virus, you could run the installation as an administrator to download App.

Home Screen of the Redtiger App

ENJOY APP

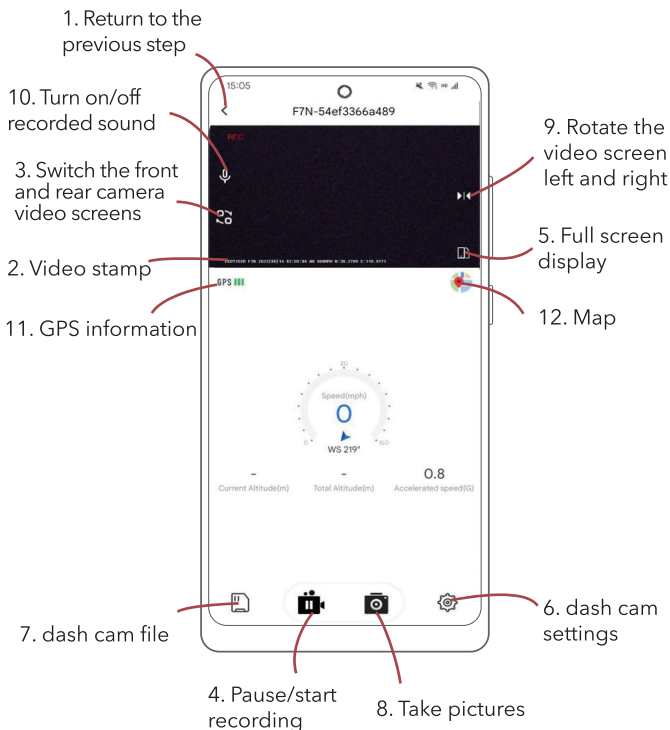

Settings Screen of the Redtiger App

How to View, Download and Delete Video

Click the icon  on the main interface to view video and picture files.

Long press the video file and select it, then choose to download or delete.

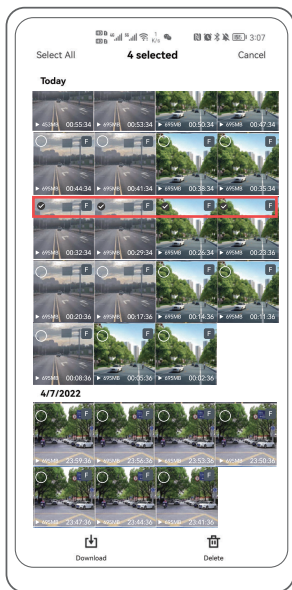

Redtiger Player

DOWNLOAD REDTIGER PLAYER

Download our Redtiger Player from website:
<https://www.redtigerscam.com/pages/gps-player>



Transfer your recordings
to computer

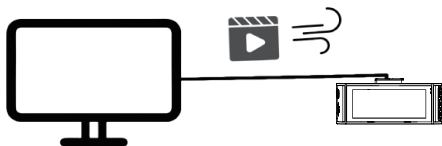

Drag in Redtiger Player



Redtiger Player

USE YOUR REDTIGER PLAYER

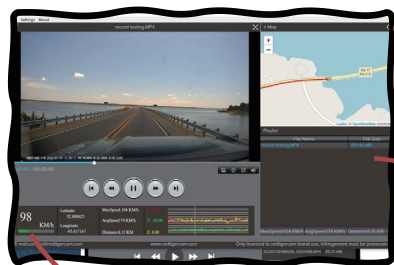

Footage Track



Choose to see your Front / Rear View

See your Speed and Location

USE YOUR REDTIGER PLAYER

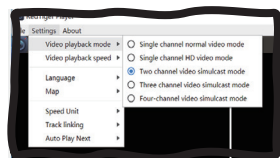

Watching Front & Rear at the same time

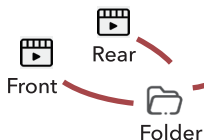
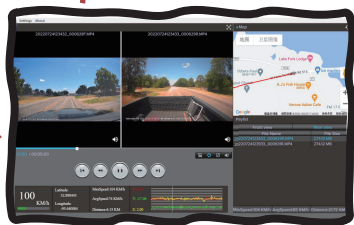

Maintenance



MAINTAIN YOUR CAMERA

Do not directly plug and unplug the cable or MicroSD card, except when the camera is turned off.

We do not encourage you connection your camera with other hardware kit, but if you insist to do this, please have a look of those lower than 6V and higher than 2.5A.

It is normal for the camera to be warm during operation. Excess exposure to heat from the sun may cause damage that isn't covered under the 1 year warranty.

Trouble Shooting



WIFI CONNECTION GOES WRONNG

Connection Prepare

- > Mobile data/VPN is off
- > 16 ft less close to your F7NP
- > Only allowed 1 device connection

Connection Notice

- > WiFi password: 12345678
- > Connect only this time or Always connect

Won't enter Parking Mode

- > Hardwire kit needed
- > The screen prompts "ACC disconnected" when trying to enter Parking Mode
- > Blue light on + Red light flash

Camera always on after Car turned down

- > Wrong connection of Red wire and Yellow wire
- > Please connect red wire with ignition fuse

Mass storage prompt on screen

This prompt will appear if you use a USB cable with data transfer mode to connect external power sources such as dash cam and laptop. At this point, your dash cam enters the data transfer mode and cannot be operated like a U disk, but you can directly see the video recorded by the dash cam on the computer.

Trouble Shooting

Over Heat

> Camera should stay between -4°F- 158°F

RECEIVED DEAD CAMERA ?

Use USB cable to connect your camera with computer and check if the screen turn on

> If not, please unplug MicroSD card and use a pin and press the Reset button at the bottom of camera

> Reconnect your camera and press 

ULTIMATE SOLUTION

> Make sure you are using the original car charger that comes with the package. If not, please replace.

> Remove the rear camera, MicroSD card, and GPS holder, and then put them back into the dash cam in sequence. Check whether the short circuit of the accessories causes the dash cam to fail to work normally.

> Check your MicroSD card is U3 Class10, if not, please change to one that is U3 Class10.

> If not, please use your personal USB charge and check again.

Check if the car charger is short-circuited and the dash cam cannot work normally.

> Please download our latest firmware to upgrade your dash cam.

> If the methods above don't solve your problem, feel free to contact Redtiger and please leave your contact information and current address which may be needed if a replacement is warranted.

This solution could be dealing with multiple problems > Won't

turn on > Restart itself > MicroSD card error > Can't auto recover >

Can't playback

Trouble Shooting

How to update the firmware

Download URL: <https://www.redtigercam.com/pages/firmware-1>

The upgrade steps:

- > Download the correct firmware to the computer.
- > Copy the firmware called "FWQ70A" to the root directory of the MicroSD card. (The file name cannot be modified)
- > Insert the MicroSD card into the machine, then insert the power cord and short press the power button (do not turn off the power during this process)
- > During the upgrade process, the blue light is always on and the red light is flashing. After the upgrade is completed, the machine will automatically turn on.

Operation video: <https://youtu.be/IMz1g3O9SPE>



Firmware download URL



Operation reference video

Customer Service

WORDS FROM HEART

Since our products are related to the safety of customers, we are committed to producing the best product quality and high-quality after sales support.

In view of no product is flawless, we sincerely believe the true measure of the company's character is what it does *after* its product does not meet expectations, we feel sorry for those customers, but deeply grateful for them to make us one more step closer to your most trustful automotive after-market brand.

We are willing to provide 1 month free return for your product, 1 year limited warranty, and lifetime technical support. Your product is guaranteed to be free of defects in materials and products from the date of purchase. In addition, you can also exchange your 1 year old product for a discounted price by contacting us online.

Behold the motif of complexity to us, simplicity to others, it's such a pleasure to listen to your advice, and we will promptly address any problems that arise.

Redtiger Customer Service Team.



Customer Service



E-MAIL



WhatsApp



Facebook



LINE

Email

Mirror Dash Cam

Email: support@redtigercam.com

Mini Dash Cam

Email: help@redtigercam.com

Business Cooperation or Others Email: contact@redtigercam.com

Customer Phone Service: +1 888 966 8028

Product Information



BASIC INFO OF YOUR CAMERA

Model	> F7NP
Display	> 3.18 inch IPS
Power	> 12V/24V
Aperture	> 1.5
Battery	> Super capacitor
Video Format	> Video: MP4 Still image: JPG
Loop recording	> 1/3/5mins
Recording method	> Normal recording/Emergency recording
Screen View	> Front & Rear view/Front view/Rearview
Resolution	> Front 3840*2160P Front 2560*1440P Front 2160P+Rear 1080P Front 1440 P+Rear1080P
GPS	> Yes
Audio	>Support sound recording and play back

Product Information



BASIC INFO OF YOUR CAMERA

G-sensor	> 3 Axis G-sensor
MicroSD card	> MicroSD 32GB-256GB
Record photo	> Main body display/Computer/ Smartphone
Temperature	> -4°F-158°F
Warranty period	> 1 Year



Redtiger

Always go-to dash cam



About Us

In an automobile-interconnection era,
everything about charm journey is within the reach of eyes.

Product and service are the foundation of Redtiger.

We have an expert research and
development team of "self-driving experts".

Based on the personal needs of users,
we use technology to drive product innovation.

In the future, we will continue
to explore the boundaries of tech to open up
a broader vision for driving.