

ONGUARD®



2017

PRODUCT CATALOG

WWW.ONGUARDLOCK.COM

ONGUARD®

OnGuard has long been known for producing the meanest, toughest locks in the business. We're the junkyard dogs of security and thieves know that when they see an OnGuard lock it's time to move on. But who says you can't teach old dogs new tricks? So we took the whole OnGuard pack and sent them to obedience school. The result is our toughest, most user-friendly line up ever.

First off you'll see a new look. Crossbar, shackle and lock head covers sport new coatings with a bright color scheme that sends a clear warning to thieves- OnGuard protected, time to look elsewhere. U-locks have metal end caps and thick rubber bumpers for improved durability.

Inside we've completely re-tooled our lock internals with tighter tolerances and higher-grade materials for better weather resistance and smoother operation. Our new Z-Cylinder features automatic keyway covers and a stronger, torque-resistant key design.

We improved our all-tube mounting brackets with an innovative Twist-Lock System for positive engagement and easy push button release.

So is there anything that's NOT new? Glad you asked. OnGuard's patented X4P Quattro locking mechanisms that secures the shackle to crossbar in four places, embroidered, not screened, chain covers, key-code registration service for secure key replacement, keyed alike options, user-settable combinations, comprehensive anti-theft programs, limited lifetime warranties and more. Plus, OnGuard is backed by the best sales and customer support team in the business.

For product, value and service, OnGuard is always your best choice.

CONTENTS

Technology	4
Features	6
U-locks	8
Chain Locks	18
Armored Cable Locks	28
Coil Cable Locks	32
Key Alike Sets	39
Cable Locks	40
Small Cable Locks	46
Padlocks	47
Disc Locks	48
Link Plate Lock	52
Locking Skewers	53
Revolver X4P Series	54
Neon Series	58
Lightweight Series	62
Rubberman Series	64
Smart Alarm Series	66
Solo Chains	69
Merchandisers	70



OnGuard Security: Comparing locks has never been easier. First assess where the lock will be used to determine security level needed: Red for ultimate security for inner city and high crime areas, blue for high security and medium crime areas, green for base security and moderate crime areas. Next, use the numbers within the color level to compare locks- the higher the number, the more security provided. This makes selecting the right lock simple and intuitive with up-selling opportunity.

SECURITY SLIDING SCALE



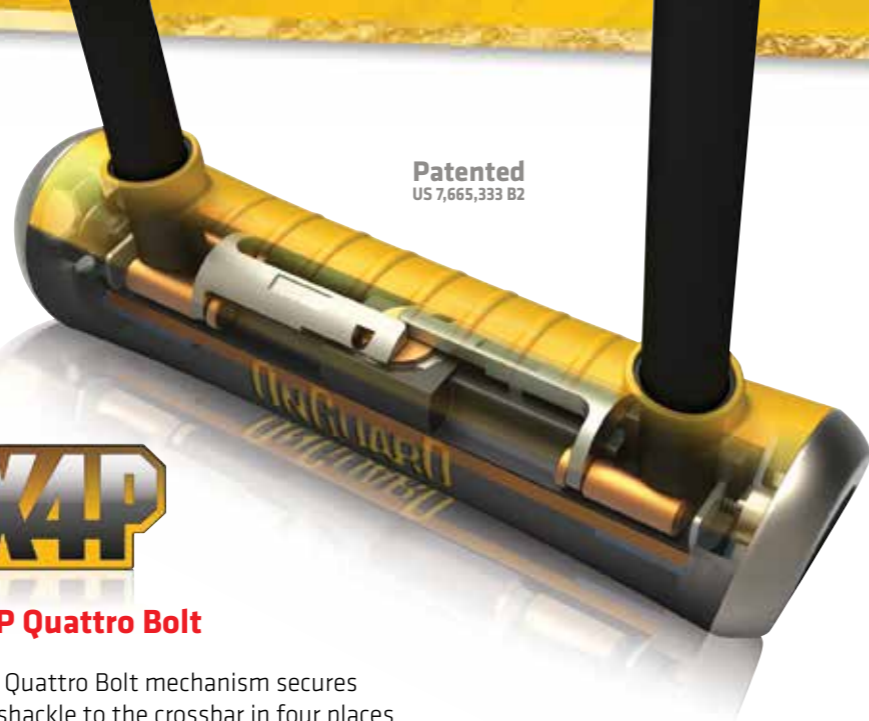

Patented
US 7,665,333 B2



X4P Quattro Bolt

X4P Quattro Bolt mechanism secures the shackle to the crossbar in four places maximizing strength to resist pulling, jacking, prying and twisting.



Pat. Pend.



X2P Dual Lock Down

Padlocks with X2P Dual Lock Down mechanisms secure both sides of the shackle for ultimate pull resistance.

ONGUARD INNOVATION MEANS MAXIMUM SECURITY

A lock is only as good as it's weakest link. And where some locks secure only one side of the shackle, OnGuard's patented X4P Quattro Bolt, X2P Double Bolt and X2P Dual Lock Down mechanisms secure both sides for a double-redundant system that resists attack from pulling, jacking and prying. And OnGuard's user-settable SBC Steel Ball Combo locks feature a high security click gear system that resists picking and pulling. Simply put, OnGuard lock technology means maximum security.

- Shackle secured at both ends for a double-redundant system
- Both sides of shackle must be defeated to open lock
- Hardened steel throughout resists all forms of attack
- Round profiles and smooth edges eliminate leverage points

Patented
US 7,823,424 B2



X2P Double Bolt

Cable locks with X2P Dual Lock Down mechanisms secure cable to lock head in two places for high pull and pry resistance.

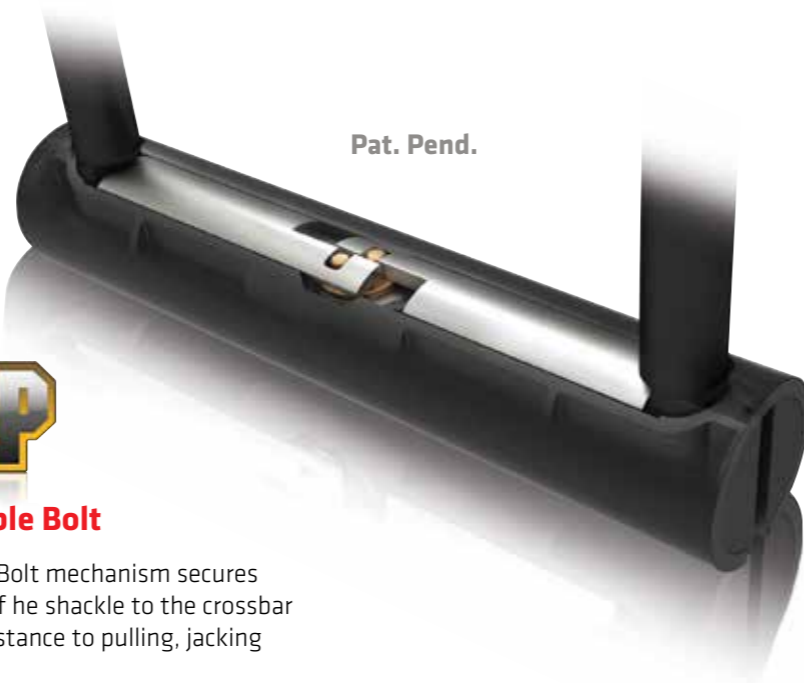

Pat. Pend.



X2P Double Bolt

X2P Double Bolt mechanism secures both sides of the shackle to the crossbar for high resistance to pulling, jacking and prying.



Pat. Pend.



Steel Ball Combo

Steel Ball Combo locks use a smooth running, steel ball click gear system that resists picking and pulling.

PROTECTION, FEATURES, VALUE- ONGUARD GIVES YOU MORE

Of course OnGuard locks offer the best security in the business. But beyond that OnGuard locks are packed with user-friendly, value added features that make closing the sale a slam dunk. From the

pick, pull, drill and bump-proof protection of the new Z-Cylinder to new double rubber coatings to the new Twist Lock mounting bracket, nobody gives you more than OnGuard.



Z-Cylinder

The Z-Cylinder offers high pick protection and feature BumpBlock™ technology rendering bump keys useless. Lock mechanism is encased in ultra-hardened steel to resist drilling or pulling.

- n The unique construction makes the Z-Cylinder virtually pickproof
- n BumpBlock renders bump keys useless
- n Ultra-steel encased mechanism defeats drilling

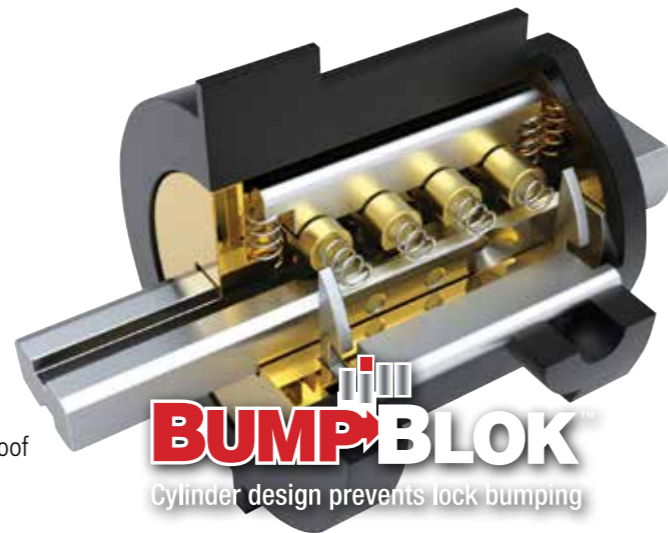

Laser-cut Keys

Locks equipped with Z-Cylinder systems come standard with 4 laser-cut keys plus 1 micro-light key for night use and can be keyed alike with other OnGuard Z-Cylinder locks. In the event that

replacement keys are needed, simply call OnGuard and with your key code (or register online after purchase) and replacement keys can be sent to you for a minimal fee.



GLO - Combo

No more fumbling with combinations in the dark. Our Doberman and Terrier Combo Glo locks feature backlit tumblers for ease of use after dark.

*Models 8031GLO, 8061 & 8062



Snap Lock QR Bracket

OnGuard Cable Locks come equipped with our new TwistLock QR Mounting Bracket is a complete redesign offering improved ease-of use. Simply attach the universal mounting bracket to any tube, insert the lock "T" fixture and twist. To release push the orange release lever and twist. Carrying your lock has never been easier.



Snap Lock QR Bracket

OnGuard U-Locks and cable locks come equipped with a universal mounting bracket that works with any size bicycle tube (22mm-80mm). Plus, the versatile design allows for a variety of placement options- down tube, top tube, seat post, offset, whatever- eliminating interference with cables, water bottle cages or other accessories. Soft rubber interface won't harm bike's finish.

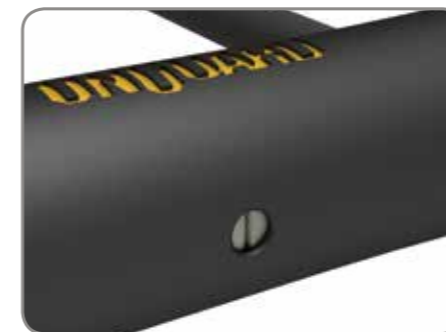

More Protection

New double rubber coatings on U-lock crossbars and shackles and cable lock heads help protect paint and finishes while metal and thick rubber end caps protect against bumps and hits. Z-Cylinders feature new automatic and manual keyway seals to keep water, dirt and grit out of lock internals. Overall tolerances are tighter for better fit and increased resistance to the elements. Chain covers are embroidered, not screened, for long lasting good looks and feature Velcro tabs to keep covers in place to protect paint and finishes. Cables feature tough vinyl coatings on both cable and swedging for long lasting durability and protection.

LOCKING TECHNOLOGY

Perfectly suited for cyclists and power sport users, OnGuard U-Locks offer our highest level of security in one convenient, easy-to-use design. OnGuard's wide range of shackle lengths, optional cables, pick, pull, bump and drill resistant Z-Cylinders or convenient combination locks, there's an OnGuard U-Lock that's exactly right for your security needs.

OnGuard U-locks feature:

- X4 and X2 locking mechanisms secure both sides of the shackle
- Hardened steel shackles are impervious to prying, jacking, or cutting
- Round profile and smooth edges eliminate leverage points
- Fully coated shackles and crossbar protects delicate finishes and paint jobs



X4P Quattro Bolt

X4P Quattro Bolt mechanism secures the shackle to the crossbar in four places maximizing strength to resist pulling, jacking, prying and twisting.

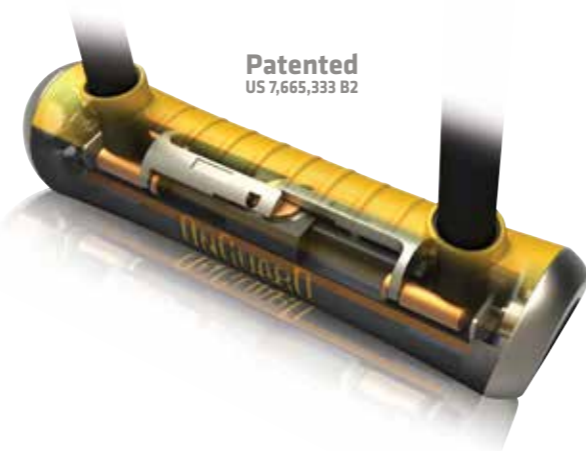

Patented
US 7,665,333 B2



X2P Double Bolt

X2P Double Bolt mechanism secures both sides of the shackle to the crossbar for high resistance to pulling, jacking and prying.



Pat. Pend.



Z-Cylinder

The Z-Cylinder offers high pick protection and feature BumpBlock™ technology rendering bump keys useless. Lock mechanism is encased in ultra-hardened steel to resist drilling or pulling.

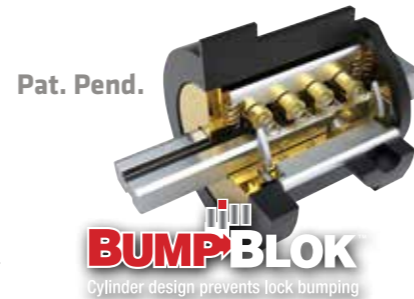

Pat. Pend.

BUMP BLOK
Cylinder design prevents lock bumping

ADDITIONAL FEATURES



Snap Lock Quick Release multi-position mounting bracket

5 laser cut keys
(1 micro-light and
4 extra grip keys)

Micro-light key
projects a bright
white beam



Brute LS
8000 | Page 10
111 x 260mm [4.53 x 10.24"]



Brute STD
8001 | Page 11
115 x 202mm [4.53 x 7.96"]



Brute Mini
8112 | Page 11
90 x 140mm [3.55 x 5.52"]



Pitbull LS
8002 | Page 12
115 x 292mm [4.53 x 11.50"]



Pitbull STD
8003 | Page 12
115 x 230mm [4.53 x 9.06"]



Pitbull DT
8005 | Page 13
115 x 230mm [4.53 x 9.06"]

120cm x 10mm
[4' x 0.39"]



Pitbull Mini
8006 | Page 13
90 x 140mm [3.55 x 5.52"]



Pitbull Medium
8006M | Page 13
90 x 175mm [3.55 x 6.90"]



Pitbull Mini LS
8007 | Page 13
90 x 240mm [3.55 x 9.46"]



Pitbull Mini DT
8008 | Page 13
90 x 140mm [3.55 x 5.52"]

120cm x 10mm
[4' x 0.39"]



Bulldog LS
8009 | Page 14
115 x 292mm [4.53 x 11.50"]



Bulldog STD
8010 | Page 14
115 x 230mm [4.53 x 9.06"]



Bulldog ATB
8011 | Page 14
127 x 230mm [5 x 9.06"]



Bulldog DT
8012 | Page 15
115 x 230mm [4.53 x 9.06"]

120cm x 10mm
[4' x 0.39"]



Bulldog Mini
8013 | Page 15
90 x 140mm [3.55 x 5.52"]



Bulldog Mini 7
8013M | Page 15
90 x 175mm [3.55 x 6.90"]

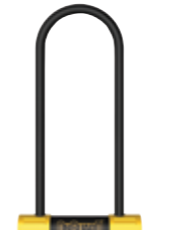

Bulldog Mini LS
8014 | Page 15
90 x 240mm [3.55 x 9.46"]



Bulldog Mini DT
8015 | Page 15
90 x 140mm [3.55 x 5.52"]

120cm x 10mm
[4' x 0.39"]



Bulldog Mini 7
8015M | Page 15
90 x 175mm [3.55 x 6.90"]



Bulldog STD LM
8010LM | Page 16
115 x 230mm [4.53 x 9.06"]

120cm x 10mm
[4' x 0.39"]



Bulldog Combo STD
8010C | Page 17
115 x 230mm [4.53 x 9.06"]



Bulldog Combo DT
8012C | Page 17
115 x 230mm [4.53 x 9.06"]



NEW 2016
Combo Mini
8013C | Page 17
90 x 140mm [3.55 x 5.52"]



NEW 2016
Combo Mini LS
8014C | Page 17
90 x 240mm [3.55 x 9.46"]



NEW 2016
Combo Mini DT
8015C | Page 17
90 x 140mm [3.55 x 5.52"]

120cm x 10mm
[4' x 0.39"]

BRUTE SERIES

- X4 Quattro Bolt Locking Mechanism
- 16.8mm [0.66"] Hardened Steel Shackle

PITBULL SERIES

- X4 Quattro Bolt Locking Mechanism
- 14mm [0.55"] Hardened Steel Shackle

PITBULL SERIES

- X4 Quattro Bolt Locking Mechanism
- 14mm [0.55"] Hardened Steel Shackle

BULLDOG SERIES

- X2 Double Bolt Locking Mechanism
- 13mm [0.51"] Hardened Steel Shackle

BULLDOG SERIES

- X2 Double Bolt Locking Mechanism
- 11-13mm [0.43-0.51"] Hardened Steel Shackle

COMBO SERIES

- X2 Double Bolt Locking Mechanism
- 13mm [0.51"] Hardened Steel Shackle

Ultimate protection for high crime areas. X4P Quattro Locking Mechanism for 4-sided protection. Massive 16.8mm (0.66") hardened steel TriRadius shackle resists all forms of cutting, prying or jacking and provides extra room for more locking options. New crossbar and shackle coatings protect finishes.

- X4P Quattro Bolt Locking Mechanism locks shackle on four sides
- NEW Z-Cylinder is bump-proof and resists picking, pulling or drilling
- NEW TriRadius shackle creates more internal space for locking versatility
- Massive 16.8mm (0.66") hardened steel shackle resists cutting, prying and jacking
- Rounded design and centered keyway eliminates pry points
- NEW co-molded crossbar cover and double rubber coated shackle protects finishes
- NEW all-metal end caps provide additional protection against hits and drops
- NEW automatic keyway covers helps seal lock internals against the elements

Locking Mechanism: X4P Quattro Bolt
Tumbler Mechanism: Z-Cylinder, European Type
Shackle Diameter: 16.8mm (0.66") Hardened Steel
Coatings: Co-molded Crossbar Cover with Metal End Caps Double Rubber Coated Shackle Cover
Keyway: Automatic Weather Resistant
Keys: 5 Laser Cut Keys, 1 With LED Micro-light
Anti-Theft Plan: \$5001 Bicycle, \$1251 Powersport
Warranty: Lifetime
Extras: All-Tube Mounting Bracket Included

X4P Locks shown on this page feature X4P Quattro bolt locking mechanisms

BRUTE SERIES | 8000
ANTI-THEFT PROTECTION OFFER
 for power sport \$1251 for bicycle \$5001



16.8MM [0.66"]



16.8MM [0.66"]

BRUTE SERIES | 8001, 8112
ANTI-THEFT PROTECTION OFFER
 for power sport \$1251 for bicycle \$5001



16.8MM [0.66"]



Locks shown on this page feature X4P Quattro bolt locking mechanisms



Brute STD | 8001
 Maximum protection in a standard length shackle. X4P Quattro Locking Mechanism for 4-sided protection, TriRadius shackle design provides extra room for more locking options while remaining compact for easy transport.

Shackle Dimensions: 115mm x 202mm (W x H x Diam)
 (4.53" x 7.96") x 16.8mm (0.66") D

ADDITIONAL FEATURES



Snap Lock Quick Release multi-position mounting bracket



5 laser cut keys (1 micro-light and 4 extra grip keys)
 Micro-light key projects a bright white beam

ADDITIONAL FEATURES



Snap Lock Quick Release multi-position mounting bracket



5 laser cut keys (1 micro-light and 4 extra grip keys)
 Micro-light key projects a bright white beam



Brute LS | 8000
 X4P Quattro Locking Mechanism for four-sided protection, longer 111x260mm (4.37x10.24") TriRadius shackle provides more locking options. Perfect for powersport applications.

Shackle Dimensions: 111mm x 260mm (W x H x Diam)
 (4.53" x 10.24") x 16.8mm (0.66") D



Brute Mini | 8112
 Bike messengers and scooter owners will love the new TriRadius shackle design that provides increased space for more locking options yet will slip easily into a messenger bag.

Shackle Dimensions: 90mm x 140mm (W x H x Diam)
 (3.55" x 5.52") x 16.8mm (0.66") D

Superior protection for medium to high crime areas. X4P Quattro Locking Mechanism for four-sided protection. Hefty 14mm (0.55") hardened steel TriRadius shackle resists cutting, prying and jacking while providing more internal space for locking versatility. New crossbar and shackle coatings protect finishes. provide increased locking versatility for securing bicycles and scooters.

- X4P Quattro Bolt Locking Mechanism locks shackle on four sides
- NEW Z-Cylinder is bump-proof and resists picking, pulling or drilling
- NEW TriRadius shackle creates more internal space for locking versatility
- Hefty 14mm (0.55") hardened steel shackle resists cutting, prying and jacking
- Rounded design and centered keyway eliminates pry points
- NEW co-molded crossbar cover and double rubber coated shackle protects finishes
- NEW all-metal end caps provide additional protection against hits and drops
- NEW automatic keyway covers helps seal lock internals against the elements

Locking Mechanism: X4P Quattro Bolt Z-Cylinder,
Tumbler Mechanism: European Type
Shackle Diameter: 14mm (0.55")
Coatings: Hardened Steel
Co-molded Crossbar Cover with metal end caps
Double Rubber Coated Shackle Cover
Keyway: Automatic Weather Resistant
Keys: 5 Laser Cut Keys, 1 With LED Micro-light
Anti-Theft Plan: \$2251 Bicycle, \$751 Powersport
Warranty: Lifetime
Extras: All-Tube Mounting Bracket Included

PITBULL SERIES
ANTI-THEFT PROTECTION OFFER
for power sport **\$751**
for bicycle **\$2251**



Locks shown on this page feature X4P Quattro bolt locking mechanisms

14MM [0.55"]



ULTIMATE SECURITY SECURITY RATING 80
10 20 30 40 50 60 70

PitBull STD | 8003

The superior protection of our X4P locking mechanism mated to a standard length 230mm (9.06") 14mm (0.55") TriRadius hardened steel shackle for more locking options.

Shackle Dimensions: 115mm x 230mm (W x H x Diam)
(4.53" x 9.06") x 14mm (0.55") D

ULTIMATE SECURITY SECURITY RATING 85
10 20 30 40 50 60 70

PitBull DT | 8005

PitBull STD double-teamed with 4 foot fully coated, braided steel cable allows user to leave front wheel on bike and extra locking versatility. X4P locking mechanism offers superior protection.

Shackle Dimensions: 115mm x 230mm (W x H x Diam)
(4.53" x 9.06") x 14mm (0.55") D
Cable Dimensions: 120cm x 10mm (4' x 0.39")

ULTIMATE SECURITY SECURITY RATING 80
10 20 30 40 50 60 70

PitBull Mini | 8006

Lighter than Brute Mini but with the advantages of X4P Locking Mechanism. Perfect for fast commuters or bike messengers who are weight sensitive.

Shackle Dimensions: 90mm x 140mm (W x H x Diam)
(3.55" x 5.52") x 14mm (0.55") D

ADDITIONAL FEATURES

5 laser cut keys (1 micro-light and 4 extra grip keys)
Micro-light key projects a bright white beam

Snap Lock Quick Release multi-position mounting bracket



Locks shown on this page feature X4P Quattro bolt locking mechanisms



ULTIMATE SECURITY SECURITY RATING 80
10 20 30 40 50 60 70

PitBull Medium | 8006M

PitBull Mini crossbar with medium shackle length to fit around new standard parking meter posts. Great for bicycle messengers. X4P locking mechanism.

Shackle Dimensions: 90mm x 175mm (W x H x Diam)
(3.55" x 6.90") x 14mm (0.55") D

ULTIMATE SECURITY SECURITY RATING 80
10 20 30 40 50 60 70

PitBull Mini LS | 8007

PitBull Mini with extra long shackle for more locking options. X4P Locking Mechanism.

Shackle Dimensions: 90mm x 240mm (W x H x Diam)
(3.55" x 9.46") x 14mm (0.55") D

ULTIMATE SECURITY SECURITY RATING 85
10 20 30 40 50 60 70

PitBull Mini DT | 8008

PitBull Mini double teamed with a 4 foot fully coated, braided steel cable for extra locking versatility.

Shackle Dimensions: 90mm x 140mm (W x H x Diam)
(3.55" x 5.52") x 14mm (0.55") D
Cable Dimensions: 120cm x 10mm (4' x 0.39")

ADDITIONAL FEATURES

Snap Lock Quick Release multi-position mounting bracket

5 laser cut keys (1 micro-light and 4 extra grip keys)
Micro-light key projects a bright white beam

ULTIMATE SECURITY SECURITY RATING 80
10 20 30 40 50 60 70

PitBull LS | 8002

X4P locking mechanism for ultimate protection with extra long 292mm (11.50") shackle length, perfect for scooter owners or anywhere high security and extra locking options are needed.

Shackle Dimensions: 115mm x 292mm (W x H x Diam)
(4.53" x 11.50") x 14mm (0.55") D

Our best selling U-locks featuring best-in-class X2P Double Bolt lock mechanisms and super strong 13mm (0.51") hardened steel shackles for a full circle of protection.

- X2P Double Bolt Locking Mechanism locks shackle on both sides
- NEW Z-Cylinder is bump-proof and resists picking, pulling or drilling
- Hefty 13mm (0.51") hardened steel shackle resists cutting, prying and jacking
- Rounded design and centered keyway eliminates pry points
- NEW double rubber coated crossbar cover protects paint and finishes
- NEW extra thick molded end caps protects against bumps and hits

Locking Mechanism: X2P Double Bolt Z-Cylinder, European Type
Tumbler Mechanism: Hardened Steel
Shackle Diameter: 13mm (0.51")
Coatings: Double Rubber Coated crossbar with extra thick end caps, fully rubber coated shackle
Keys: 5 laser-cut keys, 1 with LED micro-light
Anti-Theft Plan: \$1501 Bicycle, \$501 Powersport Lifetime
Warranty: All-Tube Mounting Bracket Included
Extras:



BULLDOG SERIES
ANTI-THEFT PROTECTION OFFER

for power sport \$501 for bicycle \$1501



Locks shown on this page feature X2P Double Bolt Locking mechanisms

13MM [0.51"]



HIGH SECURITY SECURITY 65 RATING 10 20 30 40 60 80 90 100

Bulldog STD | 8010

Standard shackle length with X2P Double Bolt protection.

Shackle Dimensions: 115mm x 230mm (W x H x Diam) (4.53" x 9.06") x 13mm (0.51") D



HIGH SECURITY SECURITY 65 RATING 10 20 30 40 60 80 90 100

Bulldog ATB | 8011

A wider crossbar dimension - 127mm (5.0") - provides extra room for securing ATBs, and scooters. X2P Double Bolt Locking Mechanism offers best-in-class protection.

Shackle Dimensions: 127mm x 230mm (W x H x Diam) (5" x 9.06") x 13mm (0.51") D

HIGH SECURITY SECURITY 65 RATING 10 20 30 40 60 80 90 100

Bulldog LS | 8009

X2P Double Bolt Locking Mechanism offers best-in-class protection, long shackle provides more locking options.

Shackle Dimensions: 115mm x 292mm (W x H x Diam) (4.53" x 11.50") x 13mm (0.51") D

ADDITIONAL FEATURES



Snap Lock Quick Release multi-position mounting bracket

5 laser cut keys (1 micro-light and 4 extra grip keys) Micro-light key projects a bright white beam



Cable: 120cm x 10mm (4' x 0.39")

13MM [0.51"]

HIGH SECURITY SECURITY 70 RATING 10 20 30 40 60 80 90 100

Bulldog DT | 8012

Bull Dog STD double-teamed with fully coated 4' braided steel cable for extra locking options.

Shackle Dimensions: 115mm x 230mm (W x H x Diam) (4.53" x 9.06") x 13mm (0.51") D

Cable Dimensions: 120cm x 10mm (4' x 0.39")



Locks shown on this page feature X2P Double Bolt Locking mechanisms

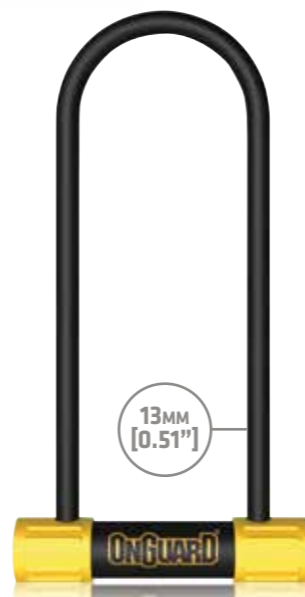

13MM [0.51"]

HIGH SECURITY SECURITY 65 RATING 10 20 30 40 60 80 90 100

Bulldog Mini LS | 8014

BullDog Mini with longer 240mm (9.46") shackle for more locking versatility.

Shackle Dimensions: 90mm x 240mm (W x H x Diam) (3.55" x 9.46") x 13mm (0.51") D



Cable: 120cm x 10mm (4' x 0.39")

13MM [0.51"]

HIGH SECURITY SECURITY 70 RATING 10 20 30 40 60 80 90 100

Bulldog Mini DT | 8015

BullDog Mini with 4 foot fully coated, braided steel cable for greater locking versatility.

Shackle Dimensions: 90mm x 140mm (W x H x Diam) (3.55" x 5.52") x 13mm (0.51") D

Cable Dimensions: 120cm x 10mm (4' x 0.39")

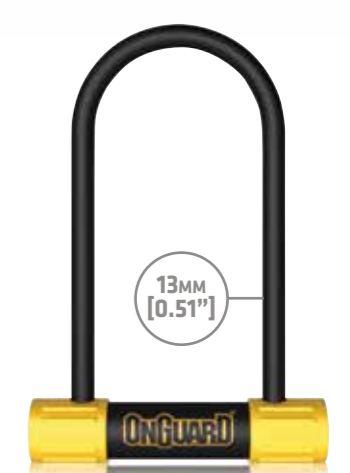

13MM [0.51"]

HIGH SECURITY SECURITY 65 RATING 10 20 30 40 60 80 90 100

Bulldog Medium | 8013M

Shorter shackle and narrower crossbar fits around new standard parking meter posts, perfect for bike messengers or others who make repeated stops in urban environments.

Shackle Dimensions: 90mm x 175mm (W x H x Diam) (3.55" x 6.90") x 13mm (0.51") D

ADDITIONAL FEATURES



5 laser cut keys (1 micro-light and 4 extra grip keys) Micro-light key projects a bright white beam

Snap Lock Quick Release multi-position mounting bracket



Cable: 120cm x 10mm (4' x 0.39")

13MM [0.51"]

HIGH SECURITY SECURITY 70 RATING 10 20 30 40 60 80 90 100

Bulldog Medium DT | 8015M

7" shackle combined with 4' braided steel cable let's you lock bike to standard parking meter post without removing front wheel.

Shackle Dimensions: 90mm x 175mm (W x H x Diam) (3.55" x 6.90") x 13mm (0.51") D

Cable Dimensions: 120cm x 10mm (4' x 0.39")

Our best selling U-locks featuring best-in-class X2P Double Bolt lock mechanisms and super strong 11-13mm (0.43-0.51") hardened steel shackles for a full circle of protection.

- X2P Double Bolt Locking Mechanism locks shackle on both sides
- NEW Z-Cylinder is bump-proof and resists picking, pulling or drilling
- Hefty 11mm (0.43") hardened steel shackle resists cutting, prying and jacking
- Rounded design and centered keyway eliminates pry points
- NEW double rubber coated crossbar cover protects paint and finishes
- NEW extra thick molded end caps protects against bumps and hits

Locking Mechanism: X2P Double Bolt Z-Cylinder, European Type
Tumbler Mechanism: European Type
Shackle Diameter: 11mm (0.43")
 Hardened Steel
Coatings: Double Rubber Coated crossbar with extra thick end caps, fully rubber coated shackle
Keys: 5 laser-cut keys, 1 with LED micro-light
Warranty: Lifetime
Extras: All-Tube Mounting Bracket Included

BULLDOG SERIES | 8010LM
ANTI-THEFT PROTECTION OFFER for bicycle **\$501**



Locks shown on this page feature X2P Double Bolt Locking mechanisms



Bulldog STD LM | 8010LM
 Standard shackle length with X2P Double Bolt protection.

Shackle Dimensions: 115mm x 230mm (W x H x Diam)
 (4.53" x 9.06") x 11mm (0.43") D

ADDITIONAL FEATURES



Snap Lock Quick Release multi-position mounting bracket



5 laser cut keys
 (1 micro-light and 4 extra grip keys)
 Micro-light key projects a bright white beam



Locks shown on this page feature X2P Double Bolt Locking mechanisms

- X2P Double Bolt Locking Mechanism locks shackle on both sides
- Combo u-locks feature steel ball Click-Combo-Gear System that's user settable with 10,000 possible variations
- Hefty 13mm (0.51") hardened steel shackle resists cutting, prying and jacking
- NEW double rubber coated crossbar cover protects paint and finishes



Locks shown on this page feature Steel Ball Click-Combo-Gear System

ADDITIONAL FEATURES

Snap Lock Quick Release multi-position mounting bracket



Combo STD | 8010C
 Popular shackle length with X2P Double Bolt protection combined with improved user-settable steel ball click-combo lock system.

Shackle Dimensions: 115mm x 230mm (W x H x Diam)
 (4.53" x 9.06") x 13mm (0.51") D



Combo DT | 8012C
 Convenience and security of Bulldog Combo STD with included 4 foot fully coated, braided steel cable for more locking options.

Shackle Dimensions: 115mm x 230mm (W x H x Diam)
 (4.53" x 9.06") x 13mm (0.51") D
Cable Dimensions: 120cm x 10mm (4' x 0.39")

COMBO SERIES | 8010C, 8012C
ANTI-THEFT PROTECTION OFFER for power sport **\$501** for bicycle **\$1501**



Combo Mini | 8013C
 Compact shackle length with X2P Double Bolt protection combined with improved user-settable steel ball click-combo lock system.

Shackle Dimensions: 90mm x 140mm (W x H x Diam)
 (3.55" x 5.52") x 13mm (0.51") D

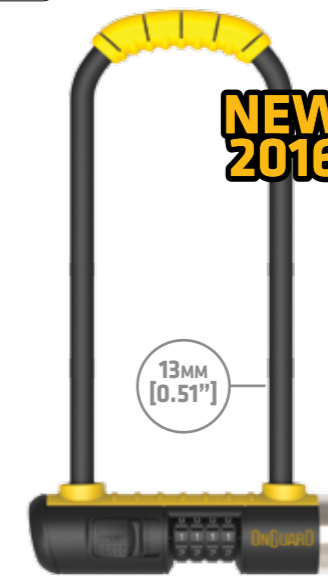

Combo Mini LS | 8014C
 Combo Mini with longer 240mm (9.46") shackle for more locking versatility.

Shackle Dimensions: 90mm x 240mm (W x H x Diam)
 (3.55" x 9.46") x 13mm (0.51") D
Cable Dimensions: 120cm x 10mm (4' x 0.39")



Combo Mini DT | 8015C
 Convenience and security of Bulldog Combo Mini with included 4 foot fully coated, braided steel cable for more locking options.

Shackle Dimensions: 90mm x 140mm (W x H x Diam)
 (3.55" x 5.52") x 13mm (0.51") D
Cable Dimensions: 120cm x 10mm (4' x 0.39")

LOCKING TECHNOLOGY

OnGuard chain locks offer bicycle owners and powersport enthusiasts extra length for locking versatility plus the highest level of security for use in high crime areas. Massive, titanium reinforced hexagonal links render hacksaws and bolt cutters virtually useless while tight inside link dimensions make prying impossible. Available in a wide variety of chain lengths and link sizes to match your security needs.

OnGuard Chain locks feature:

- Hexagonal and square links present more hardened surfaces than round links making sawing and cutting virtually impossible.
- Titanium surface hardening vastly increase cut and saw resistance.
- Embroidered nylon chain covers won't crack or peel for long lasting beauty.
- Velcro tabs keep cover in place to help protect paint and finishes.
- Comprehensive selection of locks types, chain lengths and link size to exactly match security needs.



Z-Cylinder

The Z-Cylinder offers high pick protection and feature BumpBlock™ technology rendering bump keys useless. Lock mechanism is encased in ultra-hardened steel to resist drilling or pulling.

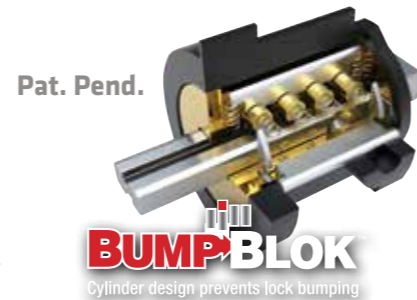

X2P Double Bolt

Cable locks with X2P Dual Lock Down mechanisms secure cable to lock head in two places for high pull and pry resistance.

Patented
US 7,823,424 B2



X4P Quattro Bolt

X4P Quattro Bolt mechanism secures the shackle to the crossbar in four places maximizing strength to resist pulling, jacking, prying and twisting.

Patented
US 7,665,333 B2

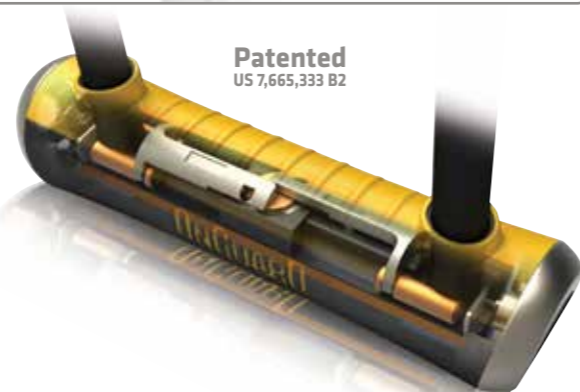

X2P Dual Lock Down

Padlocks with X2P Dual Lock Down mechanisms secure both sides of the shackle for ultimate pull resistance



ADDITIONAL FEATURES



5 laser cut keys
(1 micro-light and 4 extra grip keys)
Micro-light key projects a bright white beam



Beast 8016 | Page 20
110cm x 14mm [3.57' x 0.55"]



Beast 8016L | Page 20
180cm x 14mm [6' x 0.55"]



Beast 8017 | Page 21
110cm x 12mm [3.57' x 0.47"]



Beast 8018 | Page 21
180cm x 12mm [6' x 0.47"]

BEAST SERIES

- X4 Quattro Bolt Locking Mechanism / X2 Power Dual Lock Down
- 12-14mm [0.47-0.55"] Titanium enforced hardened steel chain
- Hexagonal chain links
- Embroidered nylon chain cover



Beast 8017LPT | Page 22
140cm x 12mm [4.54' x 0.47"]



Beast 8018L | Page 23
210cm x 12mm [7' x 0.47"]

BEAST SERIES

- X2 Double Bolt Locking Mechanism
- 12mm [0.47"] Titanium enforced hardened steel chain
- Hexagonal chain links
- Embroidered nylon chain cover



Mastiff 8019 | Page 24
110cm x 10mm [3.57' x 0.39"]



Mastiff 8019L | Page 24
180cm x 10mm [6' x 0.39"]



Mastiff 8019LP | Page 25
130cm x 10mm [4.22' x 0.39"]

MASTIFF SERIES

- X4 Quattro Bolt Locking Mechanism
- 10mm [0.39"] Titanium enforced hardened steel chain
- Hexagonal chain links
- Embroidered nylon chain cover



Mastiff 8020 | Page 26
110cm x 10mm [3.57' x 0.39"]



Mastiff 8021 | Page 26
180cm x 10mm [6' x 0.39"]



Mastiff 8022C | Page 27
80cm x 8mm [2.59' x 0.32"]



Mastiff 8022D | Page 27
80cm x 8mm [2.59' x 0.32"]

MASTIFF SERIES

- X2 Double Bolt Locking Mechanism
- X2 Power Dual Lock Down
- 4-10mm [0.16-0.39"] Titanium enforced hardened steel chain
- Square chain links
- Embroidered nylon chain cover



Mastiff 8117 | Page ?
70cm x 10mm [2.3' x 0.39"]



Mastiff 8118 | Page ?
150cm x 10mm [4.92' x 0.39"]



Mastiff 8119 | Page ?
80cm x 8mm [2.59' x 0.32"]



Mastiff 8120 | Page ?
120cm x 8mm [4' x 0.32"]

MASTIFF SERIES

- X2 Double Bolt Locking Mechanism
- X2 Power Dual Lock Down
- 4-10mm [0.16-0.39"] Titanium enforced hardened steel chain
- Square chain links
- Embroidered nylon chain cover



Mastiff 8121 | Page ?
150cm x 8mm [4.92' x 0.32"]



Mastiff 8122 | Page 27
75cm x 6mm [2.46' x 0.24"]



Mastiff 8123 | Page 27
120cm x 6mm [4' x 0.24"]



Mastiff 8124 | Page 27
75cm x 4mm [2.46' x 0.16"]



Mastiff 8125 | Page 27
120cm x 4mm [4' x 0.16"]

- X4P Quattro Bolt Locking Mechanism locks shackle on four sides
- NEW Z-Cylinder is bump-proof and resists picking, pulling or drilling
- Massive 16.8mm (0.66") hardened steel shackle resists cutting, prying and jacking
- Rounded design and centered keyway eliminates pry points
- NEW co-molded crossbar cover and double rubber coated shackle protects finishes
- NEW all-metal end caps provide additional protection against hits and drops
- NEW automatic keyway covers helps seal lock internals against the elements
- 14mm (0.55") titanium reinforced, hardened steel hexagonal link chain resists cutting or prying
- Chain cover protects paint and finishes, embroidered logo won't flake or wear off
- Boxer U-lock can also be used as a disc lock

Locking Mechanism: X4P Quattro Bolt Z-Cylinder,
European Type

Tumbler Mechanism: Hardened Steel

Shackle Diameter: 16.8mm (0.66")

Coatings: Co-molded Crossbar Cover with Metal End Caps

Keyway: Automatic Weather Resistant

Keys: 5 Laser Cut Keys, 1 With LED Micro-light

Anti-Theft Plan: \$5001 bicycle, \$1401 Powersport

Warranty: Lifetime

Extras: Embroidered chain cover



Beast | 8016

X4P Boxer short shackle U-lock mated to a 3.5' chain with massive 14mm (0.55") link titanium reinforced chain. Perfect for powersport users who travel fast but need maximum protection for high crime areas. Boxer U-lock can also be used alone as a disc lock.

Chain Dimensions: 110cm x 14mm (3.57' x 0.55")

Shackle Diameter: 16.8mm (0.66") Hardened Steel



Locks shown on this page feature X2P Dual lock down mechanisms



Beast | 8016L

Same protection features as our awesome Beast 5016 with a longer 6-foot titanium reinforced, hardened steel chain; perfect for use with trailers, racks or anywhere a longer length, ultra-high security option is needed. Boxer U-lock can also be used alone as a disc lock.

Chain Dimensions: 180cm x 14mm (6' x 0.55")

Shackle Diameter: 16.8mm (0.66") Hardened Steel

BEAST SERIES | 8016, 8016L
ANTI-THEFT PROTECTION OFFER

for power sport **\$1401** for bicycle **\$5001**

ADDITIONAL FEATURES



5 laser cut keys (1 micro-light and 4 extra grip keys)
Micro-light key projects a bright white beam



Beast | 8017

12mm chain and NEW Beast with X2P Dual Lock Down design offer ultimate protection in a lighter, more compact design.

Chain Dimensions: 110cm x 12mm (3.57' x 0.47")

Shackle Diameter: 11mm (0.43") Hardened Steel



Locks shown on this page feature X2P Dual lock down mechanisms



Beast | 8018

Longer 6' chain for more locking options, perfect for scooters and motorcycles or anywhere extra length is desired. New Beast lock with X2P Dual Lock Down protection.

Chain Dimensions: 180cm x 12mm (6' x 0.47")

Shackle Diameter: 11mm (0.43") Hardened Steel

- X2P Dual Lock Down Mechanism secure both sides of the shackle for ultimate pull resistance
- NEW Z-Cylinder is bump-proof and resists picking, pulling or drilling
- Rounded design and centered keyway eliminates pry points
- NEW co-molded crossbar cover and double rubber coated shackle protects finishes
- NEW all-metal end caps provide additional protection against hits and drops
- NEW automatic keyway covers helps seal lock internals against the elements
- 12mm (0.47") titanium reinforced, hardened steel hexagonal link chain resists cutting or prying
- Chain cover protects paint and finishes, embroidered logo won't flake or wear off

Locking Mechanism: X2P Dual Lock Down Z-Cylinder,
European Type

Tumbler Mechanism: Hardened Steel

Shackle Diameter: 11mm (0.43")

Coatings: Co-molded Crossbar Cover with Metal End Caps

Keyway: Automatic Weather Resistant

Keys: 5 Laser Cut Keys, 1 With LED Micro-light

Anti-Theft Plan: \$3501 bicycle, \$1001 Powersport

Warranty: Lifetime

Extras: Embroidered chain cover

BEAST SERIES | 8017, 8018
ANTI-THEFT PROTECTION OFFER

for power sport **\$1001** for bicycle **\$3501**

ADDITIONAL FEATURES



5 laser cut keys (1 micro-light and 4 extra grip keys)
Micro-light key projects a bright white beam

- X2P Double Bolt Locking Mechanism
- NEW Z-Cylinder is bump-proof and resists picking, pulling or drilling
- NEW all-metal end caps provide additional protection against hits and drops
- NEW automatic keyway covers helps seal lock internals against the elements
- 12mm (0.47") titanium reinforced, hardened steel hexagonal link chain resists cutting or prying
- Chain cover protects paint and finishes, embroidered logo won't flake or wear off

Locking Mechanism: X2P Double Bolt
Tumbler Mechanism: Z-Cylinder, European Type
Rod Diameter: 16mm (0.63")
Coatings: Hardened Steel
Keyway: Co-molded Crossbar Cover with Metal End Caps
Keys: Automatic Weather Resistant
Anti-Theft Plan: 5 Laser Cut Keys, 1 With LED Micro-light
Warranty: \$1401 Powersport Lifetime
Extras: Embroidered chain cover

X2P The lock shown on this page feature X2P Double Bolt Locking mechanism

ADDITIONAL FEATURES



5 laser cut keys
(1 micro-light and 4 extra grip keys)
Micro-light key projects a bright white beam

BEAST SERIES | 8017LPT
ANTI-THEFT PROTECTION OFFER for power sport
\$1401



ULTIMATE SECURITY SECURITY RATING 95
10 20 30 40 50 60 70 80 90 100

Beast | 8017LPT
Maximum security in a super versatile "loop and T" design. Simply loop the chain around a solid fixture and then slip the massive 16mm hardened steel rod through an opening on your motorcycle, scooter, ATV, whatever, and lock the T. New Beast LPT body is double rubber coated to fit comfortably in hand and provides extra protection against bumps and hits.

Chain Dimensions: 140cm x 12mm (4.54' x 0.47")
Rod Diameter: 16mm (0.63")
Hardened Steel



ULTIMATE SECURITY SECURITY RATING 95
10 20 30 40 50 60 70 80 90 100

Beast | 8018L
Extra long 7' 12mm (0.47") chain mated to New Beast lock with X2P Dual Lock Down protection.

Chain Dimensions: 210cm x 12mm (7' x 0.47") chain only



BEAST SERIES | 8018L
ANTI-THEFT PROTECTION OFFER
for power sport **\$1001** for bicycle **\$3501**

* Anti-Theft protection offer only applies if used with an OnGuard Padlock 8101 or Disk Lock 8046.

WORKS WELL WITH



◀ **Beast Padlock | 8101**
The lock shown on this page feature X2P Double Bolt Locking mechanism

Boxer | 8046 ▶
The lock shown on this page feature X4P Quattro Bolt Locking mechanism



- X4P Quattro Bolt Locking Mechanism locks shackle on four sides
- NEW Z-Cylinder is bump-proof and resists picking, pulling or drilling
- Rounded design and centered keyway eliminates pry points
- NEW co-molded crossbar cover and double rubber coated shackle protects finishes
- NEW all-metal end caps provide additional protection against hits and drops
- NEW automatic keyway covers helps seal lock internals against the elements
- 10mm (0.39") titanium reinforced, hardened steel hexagonal link chain resists cutting or prying
- Chain cover protects paint and finishes, embroidered logo won't flake or wear off
- Boxer U-lock can also be used as a disc lock

Locking Mechanism: X4P Quattro Bolt Z-Cylinder,
Tumbler Mechanism: European Type
Shackle Diameter: 14mm (0.55")
Coatings: Hardened Steel
Keyway: Co-molded Crossbar Cover with Metal End Caps
Automatic Weather Resistant
Keys: 5 Laser Cut Keys, 1 With LED Micro-light
Anti-Theft Plan: \$3001 bicycle, \$1001 Powersport
Warranty: Lifetime
Extras: Embroidered chain cover



Mastiff | 8019

A short-shackle Boxer U-lock with X4P Quattro Bolt locking mechanism paired to a 3.5-foot long, 10mm (0.39") titanium reinforced, hardened steel hexagonal link chain. Boxer U-lock can also be used alone as a disc lock.

Chain Dimensions: 110cm x 10mm (3.57' x 0.39")
Shackle Diameter: 14mm (0.55")
Hardened Steel



Locks shown on this page feature X4P Quattro bolt locking mechanisms



Mastiff | 8019L

Longer 6' 10mm (0.39") titanium reinforced, hardened steel hexagonal link chain for more locking options. Boxer U-lock can also be used alone as a disc lock.

Chain Dimensions: 180cm x 10mm (6' x 0.39")
Shackle Diameter: 14mm (0.55")
Hardened Steel



- X4P Quattro Bolt Locking Mechanism locks shackle on four sides
- NEW Z-Cylinder is bump-proof and resists picking, pulling or drilling
- Rounded design and centered keyway eliminates pry points
- NEW co-molded crossbar cover and double rubber coated shackle protects finishes
- NEW all-metal end caps provide additional protection against hits and drops
- NEW automatic keyway covers helps seal lock internals against the elements
- 4.22' x 10mm (0.39") titanium reinforced, hardened steel hexagonal link chain resists cutting or prying
- Chain cover protects paint and finishes, embroidered logo won't flake or wear off
- Boxer U-lock can also be used as a disc lock



Mastiff | 8019LP

4.22' 10mm (0.39") hexagonal link chain length saves weight yet clever cinch-loop design adds locking versatility. Short shackle Boxer U-lock with X4P Quattro Bolt locking mechanism eliminates pry points for superior protection. Boxer U-lock can also be used alone as a disc lock.

Chain Dimensions: 130cm x 10mm (4.22' x 0.39")
Shackle Diameter: 14mm (0.55")
Hardened Steel

MASTIFF SERIES | 8019, 8019L
ANTI-THEFT PROTECTION OFFER

for power sport **\$1001** for bicycle **\$3001**

ADDITIONAL FEATURES



5 laser cut keys (1 micro-light and 4 extra grip keys)
Micro-light key projects a bright white beam

MASTIFF SERIES | 8019LP
ANTI-THEFT PROTECTION OFFER

for power sport **\$1001** for bicycle **\$3001**

ADDITIONAL FEATURES



5 laser cut keys (1 micro-light and 4 extra grip keys)
Micro-light key projects a bright white beam

- X2P Double Bolt Locking Mechanism
- NEW Z-Cylinder is bump-proof and resists picking, pulling or drilling
- NEW all-metal end caps provide additional protection against hits and drops
- NEW automatic keyway covers helps seal lock internals against the elements
- 10mm (0.39") titanium reinforced, hardened steel square link chain resists cutting or prying
- Chain cover protects paint and finishes, embroidered logo won't flake or wear off

Locking Mechanism: X2P Double Bolt Z-Cylinder, European Type

Tumbler Mechanism: Crossbar Cover with Metal End Caps

Coatings: Automatic Weather Resistant

Keyway: 5 Laser Cut Keys, 1 With LED Micro-light

Keys: \$2001 bicycle, \$501 Powersport

Anti-Theft Plan: Lifetime

Warranty: Embroidered chain cover

Extras:



The lock shown on this page feature X2P Double Bolt Locking mechanism

MASTIFF SERIES | 8020, 8021, 8117, 8118

ANTI-THEFT PROTECTION OFFER

for power sport **\$501** for bicycle **\$2001**

MASTIFF SERIES | 8119, 8120, 8121, 8122

ANTI-THEFT PROTECTION OFFER

for power sport **\$501** for bicycle **\$1501**



Mastiff | 8020

3.5' 10mm (0.39") titanium reinforced hardened square link chain mated to an integrated X2P Dual Lock Down head featuring new double rubber cover for better protection against bumps and hits.

Chain Dimensions: 110cm x 10mm (3.57' x 0.39")



Mastiff | 8021

Longer 6' 10mm (0.39") titanium reinforced hardened square link chain with X2P Dual Lock Down head.

Chain Dimensions: 180cm x 10mm (6' x 0.39")



- Combo locks feature steel ball Click-Combo-Gear System that's user settable with 10,000 possible variations.
- NEW all-metal end caps provide additional protection against hits and drops
- 4-8mm (0.16-0.39") titanium reinforced, hardened steel square link chain resists cutting or prying
- Chain cover protects paint and finishes, embroidered logo won't flake or wear off

Note: Set your own four digit combination (10,000 variations) so no keys to lose or forget.



Locks shown on this page feature Steel Ball Click-Combo-Gear System



Mastiff | 8022C

User settable Steel Ball Combo lock is permanently forged to compact 2.5' 8mm (0.32") titanium reinforced hardened steel square link chain.

Chain Dimensions: 80cm x 8mm (2.59' x 0.32")



- Deadbolt Locking Mechanism for highest break resistance
- Armor protected hardened steel shackle for extra cut resistance
- 5 pin cylinder for extra pick resistance, heavy duty stainless steel body with massive inner base for enhanced security
- Rotary style lock provides smooth, one-handed operation
- Tight shackle-to-body clearance eliminates pry points and makes cutting difficult
- 5 heavy-duty F-style keys
- 8mm (0.32") titanium reinforced, hardened steel square link chain resists cutting or prying
- Chain cover protects paint and finishes, embroidered logo won't flake or wear off



Mastiff | 8117

2.3' 10mm (0.39") titanium reinforced hardened square link chain mated to an integrated X2P Dual Lock Down head featuring new double rubber cover for better protection against bumps and hits.

Chain Dimensions: 70cm x 10mm (2.3' x 0.39")



Mastiff | 8118

4.92' 10mm (0.39") titanium reinforced hardened square link chain mated to an integrated X2P Dual Lock Down head featuring new double rubber cover for better protection against bumps and hits.

Chain Dimensions: 150cm x 10mm (4.92' x 0.39")



Mastiff | 8119

2.59' 8mm (0.32") titanium reinforced hardened square link chain mated to an integrated X2P Dual Lock Down head featuring new double rubber cover for better protection against bumps and hits.

Chain Dimensions: 80cm x 8mm (2.59' x 0.32")



Mastiff | 8123

User settable Steel Ball Combo lock is permanently forged to compact 2.5' 6mm (0.24") titanium reinforced hardened steel square link chain.

Chain Dimensions: 120cm x 6mm (4' x 0.24")



Mastiff | 8122

User settable Steel Ball Combo lock is permanently forged to compact 2.5' 6mm (0.24") titanium reinforced hardened steel square link chain.

Chain Dimensions: 75cm x 6mm (2.46' x 0.24")



Mastiff | 8022D

Compact 2.5' 8mm (0.32") titanium reinforced hardened steel square link chain. Mastiff rotary lock with Deadbolt mechanism for added security.

Chain Dimensions: 80cm x 8mm (2.59' x 0.32")

Note: No light key

ADDITIONAL FEATURES



5 laser cut keys (1 micro-light and 4 extra grip keys) Micro-light key projects a bright white beam



Mastiff | 8120

4' 8mm (0.32") titanium reinforced hardened square link chain mated to an integrated X2P Dual Lock Down head featuring new double rubber cover for better protection against bumps and hits.

Chain Dimensions: 120cm x 8mm (4' x 0.32")



Mastiff | 8121

4.92' 8mm (0.32") titanium reinforced hardened square link chain mated to an integrated X2P Dual Lock Down head featuring new double rubber cover for better protection against bumps and hits.

Chain Dimensions: 150cm x 8mm (4.92' x 0.32")



Mastiff | 8124

User settable Steel Ball Combo lock is permanently forged to compact 2.5' 4mm (0.16") titanium reinforced hardened steel square link chain.

Chain Dimensions: 75cm x 4mm (2.46' x 0.16")



Mastiff | 8125

User settable Steel Ball Combo lock is permanently forged to compact 2.5' 4mm (0.16") titanium reinforced hardened steel square link chain.

Chain Dimensions: 120cm x 4mm (4' x 0.16")

ADDITIONAL FEATURES



5 heavy-duty F-style keys Note: No light key

LOCKING TECHNOLOGY

Armored cable locks offer the lighter weight of a high strength steel cable with the added protection of a hardened steel sheath that shrugs off attack from bolt and wire cutters. High strength twisted steel cable is permanently forged to a X2P Double Bolt lock head featuring new double rubber coated lock head covers for a comfortable grip and added protection against knocks and hits.

OnGuard Armored locks feature:

- High strength twisted steel cable encased in a cut-resistant hardened steel sheath that resists cutting.
- X2P Double Bolt lock mechanism provides ultimate pull resistance.
- Vinyl coated armor protect delicate paint jobs and finishes.
- NEW double rubber coated lock head covers provide better grip and protect against drops and hits.



Pat. Pend.

Z-Cylinder

The Z-Cylinder offers high pick protection and feature BumpBlock™ technology rendering bump keys useless. Lock mechanism is encased in ultra-hardened steel to resist drilling or pulling.

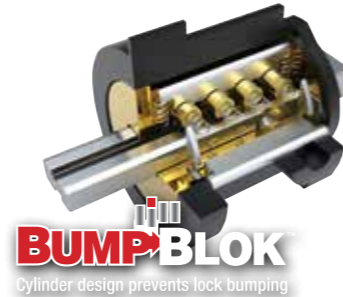

Patented
US 7,823,424 B2

X2P Double Bolt

Cable locks with X2P Dual Lock Down mechanisms secure cable to lock head in two places for high pull and pry resistance.



Steel Ball Combo

Steel Ball Combo locks use a smooth running, steel ball click gear system that resists picking and pulling.



ADDITIONAL FEATURE



5 laser cut keys
(1 micro-light and 4 extra grip keys)

Micro-light key projects a bright white beam



Rottweiler 8023 | Page 30
110cm x 30mm [3.57' x 1.18"]



Rottweiler 8023L | Page 30
220cm x 30mm [7.13' x 1.18"]

ROTTWEILER SERIES

- X2 Double Bolt Locking Mechanism
- 30mm [1.18"] Twisted steel cable protected by hardened steel links



Rottweiler 8024 | Page 31
120cm x 25mm [4' x 1"]



Rottweiler 8025 | Page 31
180cm x 25mm [6' x 1"]

ROTTWEILER SERIES

- X2 Double Bolt Locking Mechanism
- 25mm [1"] Twisted steel cable protected by hardened steel links



Rottweiler 8026 | Page 31
100cm x 20mm [3.24' x 0.79"]

ROTTWEILER SERIES

- X2 Double Bolt Locking Mechanism
- 20mm [0.79"] Twisted steel cable protected by hardened steel links



Rottweiler 8126 | Page 31
80cm x 15mm [2.62' x 0.59"]



Rottweiler 8127 | Page 31
80cm x 20mm [2.62' x 0.79"]

ROTTWEILER SERIES

- Combo locks feature steel ball Click-Combo Gear System that's user settable with 10,000 possible variations.
- 15-20mm [0.59-0.79"] Twisted steel cable protected by hardened steel links

Armored cable locks offer the lighter weight of a high strength steel cable with the added protection of a hardened steel sheath that shrugs off attack from bolt and wire cutters. High strength twisted steel cable is permanently forged to a X2P Double Bolt lock head featuring new double rubber coated lock head covers for a comfortable grip and added protection against knocks and hits.

- High strength twisted steel cable encased in a cut-resistant hardened steel sheath that resists cutting.
- X2P Double Bolt lock mechanism provides ultimate pull resistance.
- Vinyl coated armor protect delicate paint jobs and finishes.
- NEW double rubber coated lock head covers provide better grip and protect against drops and hits.

Locking Mechanism: X2P Double Bolt Z-Cylinder, European Type
Tumbler Mechanism: 20-30mm (0.79-1.19") Twisted steel cable protected by hardened steel links
Keys: 5 laser-cut keys, 1 with LED micro-light
Warranty: Lifetime



Rottweiler | 8023

X2P Double Bolt Lock for ultimate pull resistance is permanently forged to a 110cm x 30mm (3.57' x 1.18") twisted steel cable protected by hardened steel armor to resist attack from bolt and wire cutters.

Cable Dimensions: 110cm x 30mm (3.57' x 1.19")

ADDITIONAL FEATURES



5 laser cut keys (1 micro-light and 4 extra grip keys)
Micro-light key projects a bright white beam



30MM [1.19"]



Locks shown on this page feature X2P Double Bolt Locking mechanisms



Rottweiler | 8023L

Longer 220cm x 30mm (7.13' x 1.19") armored cable for more locking options. X2P Double Bolt Lock for ultimate pull resistance.

Cable Dimensions: 220cm x 30mm (7.13' x 1.19")



Rottweiler | 8024

Lighter, more flexible 120cm x 25mm (4' x 1") armored cable with X2P Double Bolt lock head.

Cable Dimensions: 120cm x 25mm (4' x 1")



Rottweiler | 8025

Same features as 5024 with longer 180cm x 25mm (6' x 1") armored steel cable for more locking options.

Cable Dimensions: 180cm x 25mm (6' x 1")



Rottweiler | 8026

Lighter weight 100cm x 20mm (3.24' x 0.79") armored steel cable with X2P Double Bolt lock head.

Cable Dimensions: 100cm x 20mm (3.24' x 0.79")



Locks shown on this page feature X2P Double Bolt Locking mechanisms

ADDITIONAL FEATURES

5 laser cut keys (1 micro-light and 4 extra grip keys)
Micro-light key projects a bright white beam



NEW 2016



Locks shown on this page feature Steel Ball Click-Combo-Gear System



Rottweiler | 8126

Improved user-settable steel ball click-combo lock system forged to a 80cm x 15mm (2.62' x 0.59") twisted steel cable protected by hardened steel armor.

Cable Dimensions: 80cm x 15mm (2.62' x 0.59")



Rottweiler | 8127

Improved user-settable steel ball click-combo lock system forged to a 80cm x 20mm (2.62' x 0.79") twisted steel cable protected by hardened steel armor.

Cable Dimensions: 80cm x 20mm (2.62' x 0.79")

LOCKING TECHNOLOGY

Light weight, easy to carry and available with either keyed or combination lock mechanisms, coil cable locks offer bike riders fast, convenient security for medium to low risk situations. Heavy-duty steel cables are permanently forged to lock heads for added security, cables are vinyl coated to protect paint and finishes.

OnGuard Coil Cable locks feature:

- Heavy-duty steel cables are self-coiling for convenience.
- Vinyl coated cables protect paint and finishes.
- Lock heads are permanently forged to cable ends.
- Key locks feature X2P Double Bolt lock heads for ultimate pull resistance.
- Combo locks feature steel ball Click-Combo-Gear System that's user settable with 10,000 possible variations.
- Attached Velcro straps contain unruly coils during transport.
- Most models include NEW All-Tube Twist Lock mounting bracket.
- New Double Rubber Coated lock head covers protect paint and finishes



Pat. Pend.

Z-Cylinder

The Z-Cylinder offers high pick protection and feature BumpBlock™ technology rendering bump keys useless. Lock mechanism is encased in ultra-hardened steel to resist drilling or pulling.



BUMPBLOK
Cylinder design prevents lock bumping



Patented
US 7,823,424 B2

X2 Double Bolt

Cable locks with X2P Dual Lock Down mechanisms secure cable to lock head in two places for high pull and pry resistance.



Steel Ball Combo

Steel Ball Combo locks use a smooth running, steel ball click gear system that resists picking and pulling.



Pat. Pend.

ADDITIONAL FEATURES



Twist Lock Quick Release multi-position mounting bracket

5 laser cut keys
(1 micro-light and
4 extra grip keys)

Micro-light key
projects a bright
white beam



Doberman 8027 | Page 34
185cm x 15mm [6' x 0.59"]



Doberman 8028 | Page 35
185cm x 12mm [6' x 0.47"]



Doberman 8029 | Page 35
185cm x 10mm [6' x 0.39"]

DOBERMAN SERIES

- X2 Double Bolt Locking Mechanism
- 10-15mm [0.39-0.59"] heavy duty self coiling cable



Doberman 8030 | Page 36
185cm x 15mm [6' x 0.59"]



Doberman 8031 | Page 37
185cm x 12mm [6' x 0.47"]



Doberman 8031L | Page 37
240m x 12mm [7.78' x 0.47"]



Doberman 8032 | Page 37
185cm x 10mm [6' x 0.32"]

DOBERMAN SERIES

- Steel ball Click-Combo Gear System has user settable combination
- 10-15mm [0.39-0.59"] heavy duty self coiling cable



Doberman 8031GLO | Page 38
185cm x 12mm [6' x 0.47"]

DOBERMAN SERIES

- Steel ball Click-Combo Gear System has user settable combination
- 12mm [0.47"] heavy duty self coiling cable



Doberman Key 8033 | Page 39
185cm x 8mm [6' x 0.32"]



Doberman Combo 8034 | Page 39
185cm x 8mm [6' x 0.32"]

DOBERMAN SERIES

- Laminated steel padlock with plated body and rubber cover / stainless steel combination padlock 48mm steel body
- 8mm [0.32"] heavy duty self coiling cable



Key Alike Set 8150 | Page 39
3 x 8028



Key Alike Set 8151 | Page 39
8003 + 8028

KEY ALIKE SETS

Light weight, easy to carry and available with either keyed or combination lock mechanisms, coil cable locks offer bike riders fast, convenient security for medium to low risk situations. Heavy-duty steel cables are permanently forged to lock heads for added security, cables are vinyl coated to protect paint and finishes.

- Heavy-duty steel cables are self-coiling for convenience.
- Vinyl coated cables protect paint and finishes.
- Lock heads are permanently forged to cable ends.
- Key locks feature X2P Double Bolt lock heads for ultimate pull resistance.
- Attached Velcro straps contain unruly coils during transport.
- Most models include NEW All-Tube Twist Lock mounting bracket.
- New Double Rubber Coated lock head covers protect paint and finishes

Locking Mechanism: X2P Double Bolt Z-Cylinder, European Type
Cable Diameter: 10-15mm (0.39-0.59") heavy duty self coiling cable
Keys: 5 laser-cut keys
Warranty: Lifetime



Locks shown on this page feature X2P Double Bolt Locking mechanisms



Doberman | 8027

The ultimate pull resistance of an X2P Power Double Bolt permanently forged to a 185cm x 15mm (6' x 0.59") heavy-duty self-coiling cable. Thick vinyl coating on cable protects paint and finishes. Attached hook-and-loop strap helps wrangle unruly cable coils. Bracket included.

Cable Dimensions: 185cm x 15mm (6' x 0.59")



Doberman | 8028

X2P Power Double Bolt lock permanently forged to medium duty 185cm x 12mm (6' x 0.47") self-coiling cable. Bracket included.

Cable Dimensions: 185cm x 12mm (6' x 0.47")



Doberman | 8029

The extra protection of a X2P Power Double Bolt lock permanently forged to a lighter duty 185cm x 10mm (6' x 0.47") self-coiling cable. Bracket included.

Cable Dimensions: 185cm x 10mm (6' x 0.39")

ADDITIONAL FEATURES



Twist Lock Quick Release multi-position mounting bracket



5 laser cut keys (1 micro-light and 4 extra grip keys) Micro-light key projects a bright white beam

ADDITIONAL FEATURES

Twist Lock Quick Release multi-position mounting bracket



5 laser cut keys

Note: no light key



Light weight, easy to carry and available with either keyed or combination lock mechanisms, coil cable locks offer bike riders fast, convenient security for medium to low risk situations. Heavy-duty steel cables are permanently forged to lock heads for added security, cables are vinyl coated to protect paint and finishes.

- Heavy-duty steel cables are self-coiling for convenience.
- Vinyl coated cables protect paint and finishes.
- Lock heads are permanently forged to cable ends.
- Combo locks feature steel ball Click-Combo-Gear System that's user settable with 10,000 possible variations.
- Attached Velcro straps contain unruly coils during transport.
- Most models include NEW All-Tube Twist Lock mounting bracket.
- New Double Rubber Coated lock head covers protect paint and finishes

Locking Mechanism: Steel ball Click-Combo-Gear System
Cable Diameter: 10-15mm (0.39-0.59") heavy duty self coiling cable
Warranty: Lifetime

SBC Locks shown on this page feature Steel Ball Click-Combo-Gear System

ADDITIONAL FEATURES



Twist Lock Quick Release multi-position mounting bracket



HIGH SECURITY SECURITY 10 20 30 40 **45** RATING 50 60 70 80 90 100   

Doberman | 8030
 User settable Steel Ball Combo lock is permanently forged to heavy-duty 185cm x 15mm (6' x 0.59") self-coiling cable. Bracket included.

Cable Dimensions: 185cm x 15mm (6' x 0.59")



HIGH SECURITY SECURITY 10 20 30 40 **40** RATING 50 60 70 80 90 100 

Doberman | 8031
 User settable Steel Ball Combo lock is permanently forged to medium-duty 185cm x 12mm (6' x 0.47") self-coiling cable. Bracket included.

Cable Dimensions: 185cm x 12mm (6' x 0.47")

HIGH SECURITY SECURITY 10 20 30 40 **40** RATING 50 60 70 80 90 100 

Doberman | 8031L
 User settable Steel Ball Combo lock is permanently forged to medium-duty 240cm x 12mm (7.78' x 0.47") self-coiling cable. Bracket included.

Cable Dimensions: 240cm x 12mm (7.78' x 0.47")

SBC Locks shown on this page feature Steel Ball Click-Combo-Gear System

BASIC SECURITY SECURITY 10 20 30 40 **35** SECURITY RATING 50 60 70 80 90 100 

Doberman | 8032
 Steel Ball Combo lock body is permanently forged to light duty 185cm x 10mm (6' x 0.39") self-coiling cable. Bracket included.

Cable Dimensions: 185cm x 10mm (6' x 0.39")

ADDITIONAL FEATURES



Twist Lock Quick Release multi-position mounting bracket

Light weight, easy to carry and available with either keyed or combination lock mechanisms, coil cable locks offer bike riders fast, convenient security for medium to low risk situations. Heavy-duty steel cables are permanently forged to lock heads for added security, cables are vinyl coated to protect paint and finishes.

- Heavy-duty steel cables are self-coiling for convenience.
- Vinyl coated cables protect paint and finishes.
- Lock heads are permanently forged to cable ends.
- Combo locks feature steel ball Click-Combo-Gear System that's user settable with 10,000 possible variations.
- Attached Velcro straps contain unruly coils during transport.
- Most models include NEW All-Tube Twist Lock mounting bracket.
- New Double Rubber Coated lock head covers protect paint and finishes

Locking Mechanism: Steel ball Click-Combo-Gear System
Cable Diameter: 12mm (0.47) heavy duty self coiling cable
Warranty: Lifetime

SBC Locks shown on this page feature Steel Ball Click-Combo-Gear System



Doberman Glo | 8031GLO

Internal LED micro light backlights the clear tumblers from within making reading the numbers after dark a breeze. Steel Ball Combo lock is permanently forged to medium duty 185cm x 12mm (6' x 0.47") self-coiling cable. Bracket included.

Cable Dimensions: 185cm x 12mm (6' x 0.47")



Doberman Key | 8033

Laminated steel padlock with smooth brass lock mechanism and 8mm (0.32") hardened steel shackle paired with a light duty 185cm x 8mm (6' x 0.32") vinyl coated twisted steel cable.

Cable Dimensions: 185cm x 8mm (6' x 0.32")

Notes: No mounting bracket included, No light key



Doberman Combo | 8034

Stainless steel combination padlock with 8mm (0.32") hardened steel shackle paired with a light duty 185cm x 8mm (6' x 0.32") vinyl coated twisted steel cable.

Cable Dimensions: 185cm x 8mm (6' x 0.32")

Note: No mounting bracket included



Key Alike Set | 8150

3 x Doberman 8028 Key Alike

Cable Dimensions: 185cm x 12mm (6' x 0.47")



Key Alike Set | 8151

Shackle Dimensions: 115mm x 230mm (4.53" x 9.06") x 14mm (0.55") D

Cable Dimensions: 185cm x 12mm (6' x 0.47")

ADDITIONAL FEATURES



Twist Lock Quick Release multi-position mounting bracket

LOCKING TECHNOLOGY

Lighter and easier to handle than chain locks, cable locks provide the extra protection of a heavy-duty twisted steel cable combined with X2P Double Bolt and Steel-Ball-Combo locks making them a great choice for cyclists and power sport users.

OnGuard Cable locks feature:

- Extra flexible steel cables for ease of use.
- Vinyl coatings protect paint and finishes.
- Lock heads are permanently forged to cable ends.
- X2P Double Bolt key lock for ultimate pull resistance.
- Steel Ball Combo lock is user-settable with 10,000 possible variations.
- Attached Velcro straps help contain cable during transport.
- New double rubber coated lock head cover protects paint and finishes
- Automatic or manual dust covers protect lock internals against the elements



Pat. Pend.

Z-Cylinder

The Z-Cylinder offers high pick protection and feature BumpBlock™ technology rendering bump keys useless. Lock mechanism is encased in ultra-hardened steel to resist drilling or pulling.



BUMPBLOK
Cylinder design prevents lock bumping



Patented
US 7,823,424 B2

X2P Double Bolt

Cable locks with X2P Dual Lock Down mechanisms secure cable to lock head in two places for high pull and pry resistance.



Steel Ball Combo

Steel Ball Combo locks use a smooth running, steel ball click gear system that resists picking and pulling.



Pat. Pend.

ADDITIONAL FEATURE



5 laser cut keys
(1 micro-light and 4 extra grip keys)

Micro-light key projects a bright white beam



Akita
8036 | Page 42
185cm x 20mm [6' x 0.79"]



Akita
8037 | Page 42
100cm x 20mm [3.24' x 0.79"]



Akita
8038 | Page 42
100cm x 15mm [3.24' x 0.59"]



Akita
8039 | Page 43
120cm x 12mm [4' x 0.47"]



Akita
8040 | Page 43
185cm x 12mm [6' x 0.47"]



Akita
8040L | Page 43
300cm x 12mm [9.73' x 0.47"]



Akita
8041 | Page 44
185cm x 12mm [6' x 0.47"]



Akita
8042 | Page 44
185cm x 10mm [6' x 0.39"]



Akita
8043 | Page 45
220cm x 10mm [7.13' x 0.39"]



Akita
8044 | Page 45
120cm x 10mm [4' x 0.39"]



Akita
8073 | Page 45
9.3m x 10mm [30.16' x 0.39"]



Akita
8080 | Page 45
4.6m x 10mm [15' x 0.39"]



Akita
8045 | Page 45
53cm x 5mm [1.72' x 0.20"]



Terrier Combo 4
8061 | Page 46
120cm x 6mm [4' x 0.24"]



Terrier Combo 7
8062 | Page 46
210cm x 6mm [7' x 0.24"]



Terrier Combo GLO
8064 | Page 46
180cm x 10mm [6' x 0.39"]



Terrier Roller
8063 | Page 46
90cm x 2mm [2.92' x 0.08"]



Terrier Roller Mini
8063M | Page 46
60cm x 1.6mm [1.95' x 0.06"]

AKITA SERIES

- X2 Double Bolt Locking Mechanism
- 15-20mm [0.59-0.79"] heavy duty extra flexible steel cable
- Non Coiled

AKITA SERIES

- X2 Double Bolt Locking Mechanism
- 12mm [0.47"] heavy duty extra flexible steel cable
- Non Coiled

AKITA SERIES

- Steel ball Click-Combo Gear System has user settable combination
- 10-12mm [0.39-0.47"] heavy duty extra flexible steel cable

AKITA SERIES

- Cinch-loop – Requires less cable for effective lock-ups
- 10mm [0.39"] heavy duty extra flexible steel cable

AKITA SERIES

- Cable permanently secured, prevents theft of quick release seats
- 5mm [0.20"] heavy duty extra flexible steel cable

TERRIER SERIES

- Set your own digit combination
- Pocket size for easy carrying
- Extra flexible steel cable

Lighter and easier to handle than chain locks, cable locks provide the extra protection of a heavy-duty twisted steel cable combined with X2P Double Bolt locks making them a great choice for cyclists and power sport users.

- Extra flexible steel cables for ease of use.
- Vinyl coatings protect paint and finishes.
- Lock heads are permanently forged to cable ends.
- X2P Double Bolt key lock for ultimate pull resistance.
- NEW Z-Cylinder is bump-proof and resists picking, pulling or drilling
- Attached Velcro straps help contain cable during transport.
- New double rubber coated lock head cover protects paint and finishes.
- Automatic or manual dust covers protect lock internals against the elements.

Locking Mechanism: X2P Double Bolt
Tumbler Mechanism: Z-Cylinder, European Type
Cable Diameter: 12-20mm (0.47-0.79") heavy duty extra flexible steel cable
Keys: 5 laser-cut keys, 1 with LED micro-light
Warranty: Lifetime



Akita | 8037
X2P Double Bolt Lock for ultimate pull resistance forged to a shorter 100cm x 20mm (3.24' x 0.79") vinyl coated extra flexible steel cable.

Cable Dimensions: 100cm x 20mm (3.24' x 0.79")



Akita | 8038
X2P Double Bolt Lock for ultimate pull resistance forged to a 100cm x 15mm (3.24' x 0.59") vinyl coated extra flexible steel cable.

Cable Dimensions: 100cm x 15mm (3.24' x 0.59")



Locks shown on this page feature X2P Double Bolt Locking mechanisms



Akita | 8036
X2P Double Bolt Lock for ultimate pull resistance is permanently forged to a heavy-duty 185cm x 20mm (6' x 0.79") extra flexible steel cable. Rubber and vinyl coatings on lock body and cable protect paint and delicate finishes.

Cable Dimensions: 185cm x 20mm (6' x 0.79")

ADDITIONAL FEATURES



5 laser cut keys
(1 micro-light and 4 extra grip keys)
Micro-light key projects a bright white beam



Akita | 8039
X2P Double Bolt Lock for ultimate pull resistance forged to a 120cm x 12mm (4' x 0.47") medium-duty, extra-flexible steel cable.

Cable Dimensions: 120cm x 12mm (4' x 0.47")



Akita | 8040
X2P Double Bolt Lock for ultimate pull resistance forged to a 185cm x 12mm (6' x 0.47") medium-duty, extra-flexible steel cable.

Cable Dimensions: 185cm x 12mm (6' x 0.47")



Akita | 8040L
X2P Double Bolt Lock forged to an extra long 300cm x 12mm (9.73' x 0.47") medium-duty, extra-flexible steel cable; ideal for securing bikes to car racks, snowmobiles and ATV to trailers or anywhere extra cable length is needed.

Cable Dimensions: 300cm x 12mm (9.73' x 0.47")

ADDITIONAL FEATURES



5 laser cut keys
Note: No light key



Locks shown on this page feature X2P Double Bolt Locking mechanisms

Lighter and easier to handle than chain locks, cable locks provide the extra protection of a heavy-duty twisted steel cable combined with Steel-Ball-Combo lock making them a great choice for cyclists and power sport users.

- Extra flexible steel cables for ease of use.
- Vinyl coatings protect paint and finishes.
- Combo locks feature steel ball Click-Combo-Gear System that's user settable with 10,000 possible variations.
- Ergonomic dials for precise usage.
- Attached Velcro straps help contain cable during transport.
- New double rubber coated lock head cover protects paint and finishes.



Akita | 8041
Convenient user-settable Steel Ball Combo lock forged to medium duty 185cm x 12mm (6' x 0.47") extra-flexible, vinyl coated steel cable.

Cable Dimensions: 185cm x 12mm (6' x 0.47")



Akita | 8042
Convenient user-settable Steel Ball Combo lock forged to light duty 185cm x 10mm (6' x 0.39") extra-flexible, vinyl coated steel cable.

Cable Dimensions: 185cm x 10mm (6' x 0.39")



Locks shown on this page feature Steel Ball Click-Combo-Gear System



10MM [0.39"]



Akita | 8043
Long 220cm x 10mm (7.13' x 0.39") medium duty vinyl coated extra-flexible steel cable with permanently swedged loops. Includes Velcro strap.

Cable Dimensions: 220cm x 10mm (7.13' x 0.39")



10MM [0.39"]



Akita | 8044
Medium 120cm x 10mm (4' x 0.39") medium duty vinyl coated extra-flexible steel cable with permanently swedged loops. Includes Velcro strap.

Cable Dimensions: 120cm x 10mm (4' x 0.39")



5MM [0.20"]



Akita | 8045
Short 53cm x 5mm (1.72' x 0.20") light duty vinyl coated extra-flexible steel cable with permanently swedged loops. Includes Velcro strap.

Cable Dimensions: 53cm x 5mm (1.72' x 0.20")



10MM [0.39"]



Akita | 8073
Super long 9.3m x 10mm (30' x 0.39") medium duty vinyl coated extra-flexible steel cable with permanently swedged, loops is great for securing snowmobiles and ATV to trailer or multiple bicycles, motorcycles or scooters.

Cable Dimensions: 9m x 10mm (30.16' x 0.39")



10MM [0.39"]



Akita | 8080
Extra long 4.6m x 10mm (15' x 0.39") medium duty vinyl coated extra-flexible steel cable with permanently swedged, loops.

Cable Dimensions: 4.6m x 10mm (15' x 0.39")

Small combo cable locks are perfect for securing skis, snowboards, helmets, leathers or other personal items that don't require maximum security.

- User settable combinations
- Large numbers are easy to see
- Glove friendly raised dials
- Vinyl coated cables protect paint and finishes



BASIC SECURITY TO 20 SECURITY RATING

Terrier Roller | 8063

Pocket-sized combo lock with 90 cm x 2mm (2.92' x 0.08") retractable cable is super convenient for securing bicycles, helmets or anytime light security is needed. User settable 3 digit combination.

Cable Dimensions: 90cm x 2mm (2.92' x 0.08")



BASIC SECURITY TO 20 SECURITY RATING

Terrier Roller | 8063M

Ultra-compact combo lock with shorter 60 cm x 1.6mm (1.95' x 0.06") retractable cable for securing bicycles, helmets or anytime light security is needed. User settable 3 digit combination.

Cable Dimensions: 60cm x 1.6mm (1.95' x 0.06")



BASIC SECURITY TO 25 SECURITY RATING

Terrier Combo 4 | 8061

Small combo lock with 120cm x 6mm (4' x 0.24") twisted steel cable provides light security for bicycles, skis, snowboards, helmets, etc.

Cable Dimensions: 120cm x 6mm (4' x 0.24")

BASIC SECURITY TO 25 SECURITY RATING

Terrier Combo 7 | 8062

Small combo lock with same features as 8061 but with a longer 210cm x 6mm (7' x 0.24") cable for more locking options.

Cable Dimensions: 210cm x 6mm (7' x 0.24")



BASIC SECURITY TO 35 SECURITY RATING

Terrier Combo Glo | 8064

Internal LED microlight illuminates the clear tumblers making reading the numbers after dark a breeze. Small combo lock with 180cm x 10mm (6' x 0.39") twisted steel cable provides light security for bicycles, skis, snowboards, helmets, etc.

Cable Dimensions: 180cm x 10mm (6' x 0.39")



ULTIMATE SECURITY TO 80 SECURITY RATING

Beast | 8101

Beast padlock featuring X2P Dual Lock Down mechanism that secures shackle on both sides with a super-short 11mm (0.43") shackle that provides no leverage points for prying or jacking. Rubber coated lock body protects paint and finishes.

- X2P Dual Lock Down mechanism secures shackle on both sides
- Z-Cylinder resists all attacks from picking, pulling or drilling
- Double Rubber coated body protect finishes and paint

Shackle Diameter: 11mm (0.43")
Hardened Steel



HIGH SECURITY TO 50 SECURITY RATING

BullMastiff | 8102

Laminated steel padlock with smooth brass lock mechanism and 10mm (0.39") hardened steel shackle.

- Laminated steel padlock with brass internals with 10mm (0.39") hardened steel shackle
- Non-marring padlock bumper protects paint and finishes
- 5 heavy-duty F-style keys

Shackle Diameter: 10mm (0.39")
Hardened Steel

ADDITIONAL FEATURES

5 heavy-duty F-style keys



HIGH SECURITY TO 40 SECURITY RATING

BullMastiff | 8103

The 8103 Bull Mastiff features smooth, one-handed rotary operation and tight shackle-to-body clearance to eliminate pry points to make cutting difficult.

- Rotary style lock provides smooth, one-handed operation
- Tight shackle-to-body clearance eliminates pry points and makes cutting difficult
- 5 heavy-duty F-style keys

Shackle Diameter: 10mm (0.39")
Hardened Steel

ADDITIONAL FEATURES

5 heavy-duty F-style keys



ADDITIONAL FEATURES



5 laser cut keys
(1 micro-light and 4 extra grip keys)
Micro-light key projects a bright white beam



HIGH SECURITY TO 40 SECURITY RATING

BullMastiff | 8104

Stainless steel combination padlock with 8mm (0.32") hardened steel shackle.

- Stainless steel combo lock with 8mm (0.32") hardened steel shackle

Shackle Diameter: 8mm (0.32")
Hardened Steel

LOCKING TECHNOLOGY

Disc locks provide motorcyclists and other power sports users outstanding security in a small convenient size. Shackle models work as a stand-alone rotor lock or with a chain for more locking options. Stapler and pin type models offer great protection against drive off thefts and easily fit in a pocket or tank bag. Most disc locks come with carrying case and disc reminder cable to prevent accidental drive aways.

OnGuard Disc locks feature:

- X4P lock mechanism on Boxers secure both sides of the shackle.
- Hardened steel shackles and pins resist prying, cutting or jacking
- Rubber coatings protect paint and finishes
- Most models include carrying case and disc reminder cable



Z-Cylinder

The Z-Cylinder offers high pick protection and feature BumpBlock™ technology rendering bump keys useless. Lock mechanism is encased in ultra-hardened steel to resist drilling or pulling.



X4P Quattro Bolt

X4P Quattro Bolt mechanism secures the shackle to the crossbar in four places maximizing strength to resist pulling, jacking, prying and twisting.

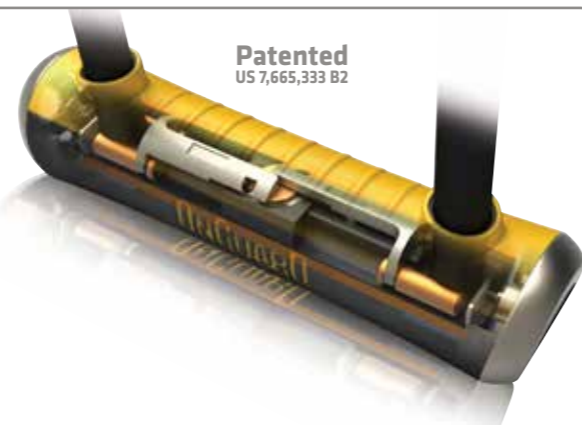

ADDITIONAL FEATURES



5 laser cut keys
(1 micro-light and 4 extra grip keys)
Micro-light key projects a bright white beam



Carrying pouch with belt clip
The disc reminder prevents riding away while disc lock is still engaged



Boxer 8046 | Page 50
55 x 55mm [2.17 x 2.17"]



Boxer 8048 | Page 50
55 x 55mm [2.17 x 2.17"]



Boxer 8048C | Page 50
55 x 55mm [2.17 x 2.17"]

BOXER SERIES

- X4 Quattro Bolt Locking Mechanism
- 14-16.8mm [0.55-0.66"] ultra hardened steel shackle



Boxer 8051 | Page 51
5.5mm [0.22"]



Boxer 8052 | Page 51
10mm [0.39"]



Boxer 8054 | Page 51
8mm [0.32"]



Boxer 8107 | Page 51
5.5mm [0.22"]

BOXER SERIES

- Touch lock system
- 5.5-10mm [0.22-0.39"] ultra hardened steel pin
- Stapler type disc lock



Double Team 8110 | Page 51
Disc lock + cable: 8052 + 8062

Disc Reminder 8056 | Page 51

BOXER SERIES

- Touch lock system
- 10mm [0.39"] ultra hardened steel pin

Boxer Series:

Small enough to fit in a jacket pocket or tank bag, disc locks are great for motorcyclists and other power sport users. Boxer Series shackle locks can be used as stand-alone rotor locks or combined with a chain or cable for more locking options. Stapler and pin type models offer great protection against drive off theft. Most locks come with carrying case and bright orange reminder cable to prevent accidental drive aways.

- X4P lock mechanism on Boxers secure both sides of the shackle.
- Hardened steel shackles and pins resist prying, cutting or jacking
- Rubber coatings protect paint and finishes
- Most models include carrying case and disc reminder cable

X4P Locks shown on this page feature X4P Quattro bolt locking mechanisms

BOXER SERIES | 8046, 8048, 8048C
ANTI-THEFT PROTECTION OFFER for power sport **\$751**



ULTIMATE SECURITY SECURITY RATING 95 RATING 10 20 30 40 50 60 70 80 90 100

Boxer | 8046

Large 55mm x 55mm (2.17" x 2.17") opening fits large disc and rotor openings. Massive 16.8mm (0.66") hardened steel shackle resists all attack from cutting, prying or jacking. X4P Quattro Bolt locking system secures the shackle on four sides for ultimate protection. Included disc reminder helps prevent accidental drive offs.

Shackle Diameter: 16.8mm (0.66")
Hardened Steel



ULTIMATE SECURITY SECURITY RATING 85 RATING 10 20 30 40 50 60 70 80 90 100

Boxer | 8048C

Same as 8048C with yellow colored shackle to further remind rider that disc is locked.

Shackle Diameter: 14mm (0.55")
Hardened Steel

ULTIMATE SECURITY SECURITY RATING 85 RATING 10 20 30 40 50 60 70 80 90 100

Boxer | 8048

Large 55mm x 55mm (2.17" x 2.17") opening fits many disc and rotor openings. 14mm (0.55") hardened steel shackle resists all attack from cutting, prying or jacking. X4P Quattro Bolt locking system secures the shackle on four sides for ultimate protection. Included disc reminder helps prevent accidental drive offs.

Shackle Diameter: 14mm (0.55")
Hardened Steel



Disc Reminder | 8056

The disc reminder prevents riding away while disc lock is still engaged

HIGH SECURITY SECURITY RATING 50 RATING 10 20 30 40 50 60 70 80 90 100

Boxer | 8051

Stapler-style disc lock featuring Touch Lock System for convenient one-hand operation. Pick, pull and drill resistant Z-Cylinder locking mechanism. 5.5mm (0.22") hardened steel pin secures lock to disc, includes disc reminder cable and carrying pouch.

Pin Dimensions: 5.5mm (0.22"),
Hardened Steel

HIGH SECURITY SECURITY RATING 60 RATING 10 20 30 40 50 60 70 80 90 100

Boxer | 8052

Stapler-style disc lock featuring Touch Lock System secured by a pick, pull and drill resistant Z-Cylinder locking mechanism. Larger 10mm (0.39") hardened steel pin secures lock to disc, includes disc reminder cable and carrying pouch.

Pin Dimensions: 10mm (0.39"),
Hardened Steel

HIGH SECURITY SECURITY RATING 55 RATING 10 20 30 40 50 60 70 80 90 100

Boxer | 8054

Stapler-style disc lock featuring a Touch Lock System secured by a pick, pull and drill resistant M-Cylinder locking mechanism. Intermediate 8mm (0.32") hardened steel pin secures lock to disc, includes disc reminder cable and carrying pouch.

Pin Dimensions: 8mm (0.32"),
Hardened Steel



HIGH SECURITY SECURITY RATING 60 RATING 10 20 30 40 50 60 70 80 90 100

Double Team | 8110

Double Team it with a 8052 stapler-style disc lock combined with a Terrier Glo Combo 7 8062 vinyl coated cable lock for securing helmets, leathers or other small items.



Boxer Stapler style Series:

- Z-Cylinder resists all attacks from picking, pulling or drilling
- Touch lock system for one-hand operation
- 5.5-10mm (0.22") hardened steel pin secures lock to disc
- Rounded design and centered keyway eliminates pry points
- Coated surfaces protect finishes and paint
- Disc reminder cable helps prevent accidental drive offs
- Included carrying pouch with belt clip

HIGH SECURITY SECURITY RATING 45 RATING 10 20 30 40 50 60 70 80 90 100

Boxer | 8107

Elegant stapler-style disc lock featuring Touch Lock System secured by a pick, pull and drill resistant Z-Cylinder locking mechanism. 5.5mm (0.22") hardened steel pin secures lock to disc, flip-open keyway cover keeps lock internals clean and operating smoothly. Additional opening provides convenient place for another cable or lock.

Pin Dimensions: 5.5mm (0.22"),
Hardened steel
Available with: 2 keys and carrying pouch (no light key)



ADDITIONAL FEATURES



5 laser cut keys
(1 micro-light and 4 extra grip keys)
Micro-light key projects a bright white beam



Carrying pouch with belt clip



The disc reminder prevents riding away while disc lock is still engaged

This unique lock combines near U-lock security with the ease of use and versatility of a cable lock. Remarkably compact the K-9 is constructed of hardened steel plates and features OnGuard's pick, pull and drill proof Z-Cylinder. Once unfolded, the K-9 has the length to secure frames and wheels to a rack or other solid object. Included mounting bracket mounts to most bicycle tubes for easy transport.

ADDITIONAL FEATURES



5 laser cut keys
(1 micro-light and 4 extra grip keys)
Micro-light key projects a bright white beam



Heavy Duty Link Plate Lock K9 | 8113

K9 Dimensions: 79cm (2.56')



Heavy Duty Link Plate Lock K9 | 8114

K9 Dimensions: 112.5cm (3.69')

Combo K9 feature steel ball Click-Combo-Gear System that's user settable with 10,000 possible variations.



Link Plate Lock K9 Key | 8116

K9 Dimensions: 75cm (2.46')



Link Plate Lock K9 Combo | 8115

K9 Dimensions: 88.5cm (2.9')

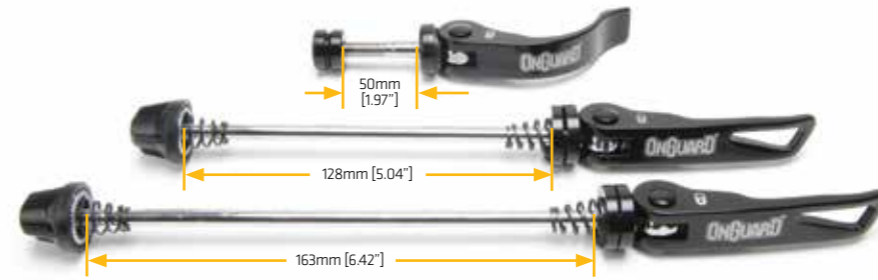

MinPin | 8400
3 Piece Locking Skewer Set

Locking front and rear QR wheel skewer set combined with locking QR seat post clamp.

Skewer Dimensions: 5 x 163mm (0.20" x 6.42")
5 x 128mm (0.20" x 5.04")
5 x 50mm (0.20" x 1.97")

MinPin Keyless Locking QR Sets

Replacement front and rear wheel QR skewers and QR seatpost clamp that use innovative patented lock system to prevent QR from opening unless bike is tilted over 90 deg from level. Simply lock bike with wheels attached so that it can't be tipped more than 90 deg. To unlock, tip bike past 90 deg and open QR levers.

- Keyless anti-theft for front and rear wheels and seatpost
- No tools required
- Light weight

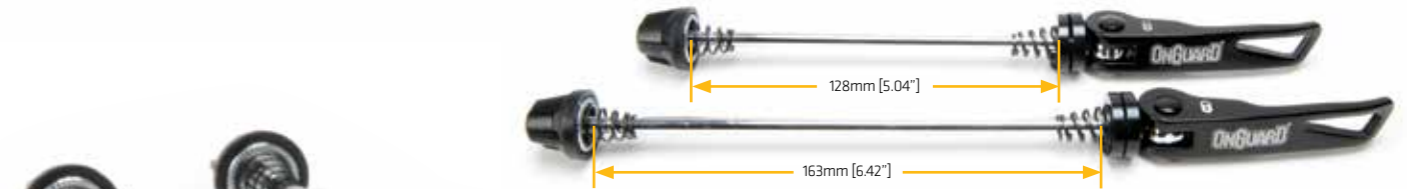

MinPin | 8200
2 Piece Locking Skewer Set

Locking front and rear wheel QR skewer set.

Skewer Dimensions: 5 x 163mm (0.20" x 6.42")
5 x 128mm (0.20" x 5.04")

ALL NEW CATEGORY

REVOLVER X4P

Born from brilliant engineering

Our engineers developed revolutionary new technologies that make our locks **better, stronger, and lighter.**

- Ultra-strong, lightweight aluminum-steel alloys
- First ever COMBO X4P
- New Steel as Strong as Titanium
- More secure and more user friendly than anything else on the market



Locks shown on this page feature X4P Quattro bolt locking mechanisms





**Coil Cable Lock
Revolver X4P | 8138**

Dimensions: 185cm x 12mm (6' x 0.47")



**Coil Cable Lock
Revolver X4P | 8139**

Dimensions: 185cm x 15mm (6' x 0.59")



**Cable Lock
Revolver X4P | 8142**

Dimensions: 80cm x 12mm (2.62' x 0.47")

**Cable Lock
Revolver X4P | 8143**

Dimensions: 120cm x 12mm (3.94' x 0.47")

ADDITIONAL FEATURES



5 laser cut keys
(1 micro-light and 4 extra grip keys)
Micro-light key projects a bright white beam



**Link Plate Lock
Revolver X4P | 8128**

Dimensions: 79cm (2.56')

**Link Plate Lock
Revolver X4P | 8129**

Dimensions: 112.5cm (3.69')



Locks shown on this page feature X4P Quattro bolt locking mechanisms



**Chain Lock
Revolver X4P | 8132**

Dimensions 80cm x 8mm
(2.62' x 0.31")



**Chain Lock
Revolver X4P | 8133**

Dimensions 120cm x 8mm
(3.94' x 0.31")

**Chain Lock
Revolver X4P | 8134**

Dimensions 150cm x 8mm
(4.92' x 0.31")



**Armored Lock
Revolver X4P | 8146**

Dimensions: 80cm x 15mm (2.62' x 0.59")

**Armored Lock
Revolver X4P | 8147**

Dimensions: 120cm x 15mm (3.94' x 0.59")



**Coil Cable Lock Combo
Revolver X4P | 8140**

Dimensions: 185cm x 12mm (6' x 0.47")



**Coil Cable Lock Combo
Revolver X4P | 8141**

Dimensions: 185cm x 15mm (6' x 0.59")



**Combo Cable Lock
Revolver X4P | 8144**

Dimensions: 80cm x 12mm (2.62' x 0.47")

**Combo Cable Lock
Revolver X4P | 8145**

Dimensions: 120cm x 12mm (3.94' x 0.47")



Locks shown on this page feature Steel Ball Click-Combo-Gear System



**Link Plate Lock Combo
Revolver X4P | 8130**

Dimensions: 79cm (2.56')

**Link Plate Lock Combo
Revolver X4P | 8131**

Dimensions: 112.5cm (3.69')



Locks shown on this page feature X4P Quattro bolt locking mechanisms



**Chain Lock Combo
Revolver X4P | 8135**

Dimensions 80cm x 8mm
(2.62' x 0.31")



**Chain Lock Combo
Revolver X4P | 8136**

Dimensions 120cm x 8mm
(3.94' x 0.31")

**Chain Lock Combo
Revolver X4P | 8137**

Dimensions 150cm x 8mm
(4.92' x 0.31")



**Armored Combo Lock
Revolver X4P | 8148**

Dimensions: 80cm x 15mm (2.62' x 0.59")

**Armored Combo Lock
Revolver X4P | 8149**

Dimensions: 120cm x 15mm (3.94' x 0.59")

The DS system is an innovative leap in design, introducing significant features and benefits over existing locking systems and cylinders.

The world's first spring free patented locking system and cylinder.
No more jammed locks

Neon U-Lock | 8152

Shackle Dimensions: 115mm x 292mm
(W x H x Diam)
11mm (0.43") D

Neon U-Lock | 8153

Shackle Dimensions: 115mm x 230mm
(W x H x Diam)
11mm (0.43") D

Neon U-Lock | 8155

Shackle Dimensions: 90mm x 140mm
(W x H x Diam)
11mm (0.43") D

Bracket and 2 keys included



Neon U-Lock + cable | 8154

Shackle Dimensions: 115mm x 230mm
(W x H x Diam)
11mm (0.43") D
Cable Dimensions: 120cm x 10mm
(4' x 0.39")

Bracket and 2 keys included



Neon Coil Cable Lock | 8156

Cable Dimensions: 180cm x 12mm
(6' x 0.47")

Neon Coil Cable Lock | 8157

Cable Dimensions: 180cm x 10mm
(6' x 0.39")

Neon Coil Cable Lock | 8158

Cable Dimensions: 180cm x 8mm
(6' x 0.31")

Neon Cable Lock | 8162

Cable Dimensions: 180cm x 12mm
(6' x 0.47")

Neon Cable Lock | 8163

Cable Dimensions: 120cm x 12mm
(4' x 0.47")

Neon Cable Lock | 8164

Cable Dimensions: 180cm x 10mm
(6' x 0.39")

Neon Cable Lock | 8165

Cable Dimensions: 120cm x 10mm
(4' x 0.39")

Neon Cable Lock | 8166

Cable Dimensions: 180cm x 8mm
(6' x 0.31")

Neon Cable Lock | 8167

Cable Dimensions: 120cm x 8mm
(4' x 0.31")



Neon Combo Coil Cable Lock | 8159

Cable Dimensions: 180cm x 12mm
(6' x 0.47")

Neon Combo Coil Cable Lock | 8160

Cable Dimensions: 180cm x 10mm
(6' x 0.39")

Neon Combo Coil Cable Lock | 8161

Cable Dimensions: 180cm x 8mm
(6' x 0.31")

Neon Combo Cable Lock | 8168

Cable Dimensions: 180cm x 12mm
(6' x 0.47")

Neon Combo Cable Lock | 8169

Cable Dimensions: 120cm x 12mm
(4' x 0.47")

Neon Combo Cable Lock | 8170

Cable Dimensions: 180cm x 10mm
(6' x 0.39")

Neon Combo Cable Lock | 8171

Cable Dimensions: 120cm x 10mm
(4' x 0.39")

Neon Combo Cable Lock | 8172

Cable Dimensions: 180cm x 8mm
(6' x 0.31")

Neon Combo Cable Lock | 8173

Cable Dimensions: 120cm x 8mm
(4' x 0.31")



Neon Padlock | 8240

Shackle Dimensions: 8mm (0.32") D

The Magnum DS system is an innovative leap in design, introducing significant features and benefits over existing locking systems and cylinders.

The world's first spring free patented locking system and cylinder. No more jammed locks

Neon Padlock + Cable | 8241

Shackle Dimensions: 8mm (0.32") D
Cable Dimensions: 120cm x 10mm (4' x 0.39")



Neon Padlock + Chain | 8242

Shackle Dimensions: 8mm (0.32") D
Chain Dimensions: 120cm x 6mm (4' x 0.24")



DS
SPRING FREE
LOCKING SYSTEM



Neon Combo Padlock | 8243

Shackle Dimensions: 8mm (0.32") D

Small combo locks are perfect for securing skis, snowboards, helmets, leathers or other personal items that don't require maximum security.

- User settable combinations
- Large numbers are easy to see
- Glove friendly raised dials
- Vinyl coated cables protect paint and finishes



Neon Combo Padlock + Cable | 8244

Shackle Dimensions: 8mm (0.32") D
Cable Dimensions: 120cm x 10mm (4' x 0.39")



Neon Combo Padlock + Chain | 8245

Shackle Dimensions: 8mm (0.32") D
Chain Dimensions: 120cm x 6mm (4' x 0.24")

CABLE LOCKS

Light weight, easy to carry and available with either keyed or combination lock mechanisms, cable locks offer bike riders fast, convenient security for medium to low risk situations. Heavy-duty steel cables are permanently forged to lock heads for added security, cables are vinyl coated to protect paint and finishes.

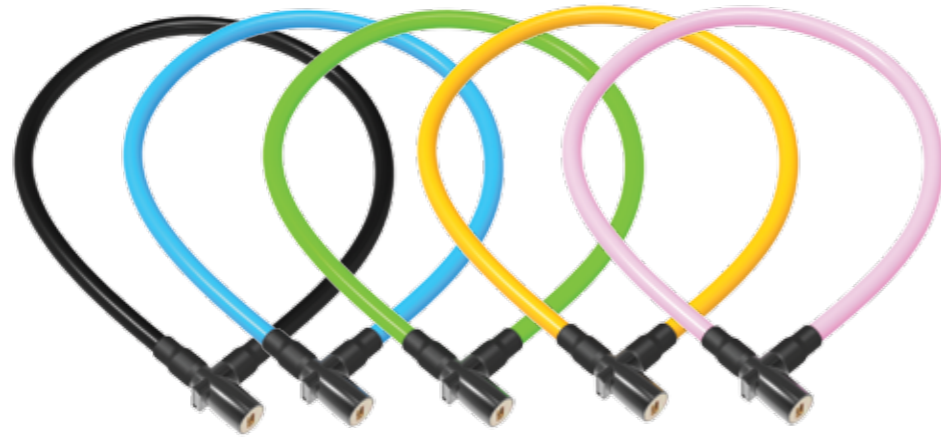

Lightweight Key Cable Lock | 8187

Cable Dimensions: 60cm x 6mm
(1.97' x 0.24")
2 keys included

Lightweight Key Cable Lock | 8188

Cable Dimensions: 80cm x 6mm
(2.62' x 0.24")
2 keys included



Lightweight Combo Cable Lock | 8189

Cable Dimensions: 60cm x 6mm
(1.97' x 0.24")

Lightweight Combo Cable Lock | 8190

Cable Dimensions: 80cm x 6mm
(2.62' x 0.24")

CABLE LOCKS

Light weight, easy to carry and available with either keyed or combination lock mechanisms, cable locks offer bike riders fast, convenient security for medium to low risk situations. Heavy-duty steel cables are permanently forged to lock heads for added security, cables are vinyl coated to protect paint and finishes.

COIL CABLE LOCKS

Light weight, easy to carry and available with either keyed or combination lock mechanisms, coil cable locks offer bike riders fast, convenient security for medium to low risk situations. Heavy-duty steel cables are permanently forged to lock heads for added security, cables are vinyl coated to protect paint and finishes.

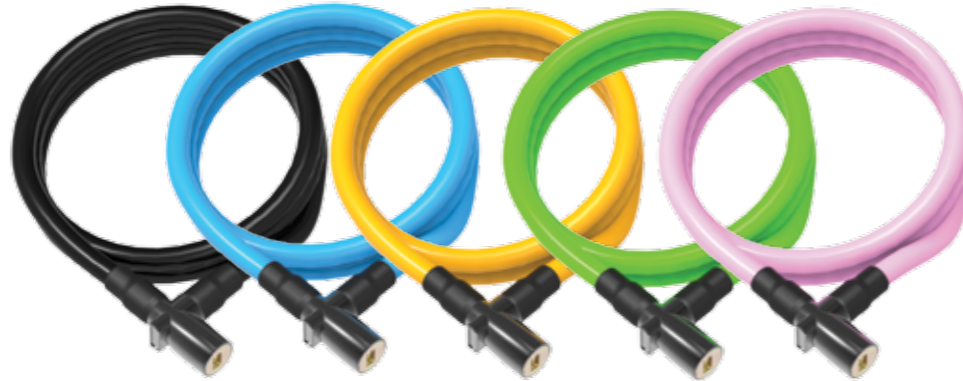

Lightweight Key Coil Cable Lock | 8191

Cable Dimensions: 120cm x 8mm
(4' x 0.32")
2 keys included

Lightweight Key Cable Lock | 8192

Cable Dimensions: 150cm x 8mm
(4.92' x 0.32")
2 keys included



Lightweight Combo Coil Cable Lock | 8193

Cable Dimensions: 120cm x 8mm
(4' x 0.32")

Lightweight Combo Cable Lock | 8194

Cable Dimensions: 150cm x 8mm
(4.92' x 0.32")

COIL CABLE LOCKS

Light weight, easy to carry and available with either keyed or combination lock mechanisms, coil cable locks offer bike riders fast, convenient security for medium to low risk situations. Heavy-duty steel cables are permanently forged to lock heads for added security, cables are vinyl coated to protect paint and finishes.

CHAIN LOCKS

Light weight, easy to carry and available with either keyed or combination lock mechanisms, chain locks offer bike riders fast, convenient security for medium to low risk situations. Heavy-duty steel chains are permanently forged to lock heads for added security, chains are vinyl coated to protect paint and finishes.



Lightweight Key Chain Lock | 8195

Chain Dimensions: 60cm x 4mm
(1.97' x 0.16")
2 keys included

Lightweight Key Chain Lock | 8196

Chain Dimensions: 80cm x 4mm
(2.62' x 0.16")
2 keys included



Lightweight Combo Chain Lock | 8197

Chain Dimensions: 60cm x 4mm
(1.97' x 0.16")

Lightweight Combo Chain Lock | 8198

Chain Dimensions: 80cm x 4mm
(2.62' x 0.16")

CHAIN LOCKS

Light weight, easy to carry and available with either keyed or combination lock mechanisms, chain locks offer bike riders fast, convenient security for medium to low risk situations. Heavy-duty steel chains are permanently forged to lock heads for added security, chains are vinyl coated to protect paint and finishes.

Silicone overmoulded braided steel cable with fibre core, light weight, easy to carry and available with either keyed or combination lock mechanisms, locks offer bike riders fast, convenient security for medium to low risk situations. Heavy-duty steel cables are permanently forged to lock heads for added security, cables are silicone coated to protect paint and finishes.

Silicone overmoulded braided steel cable with fibre core, light weight, easy to carry and available with either keyed or combination lock mechanisms, locks offer bike riders fast, convenient security for medium to low risk situations. Heavy-duty steel cables are permanently forged to lock heads for added security, cables are silicone coated to protect paint and finishes.

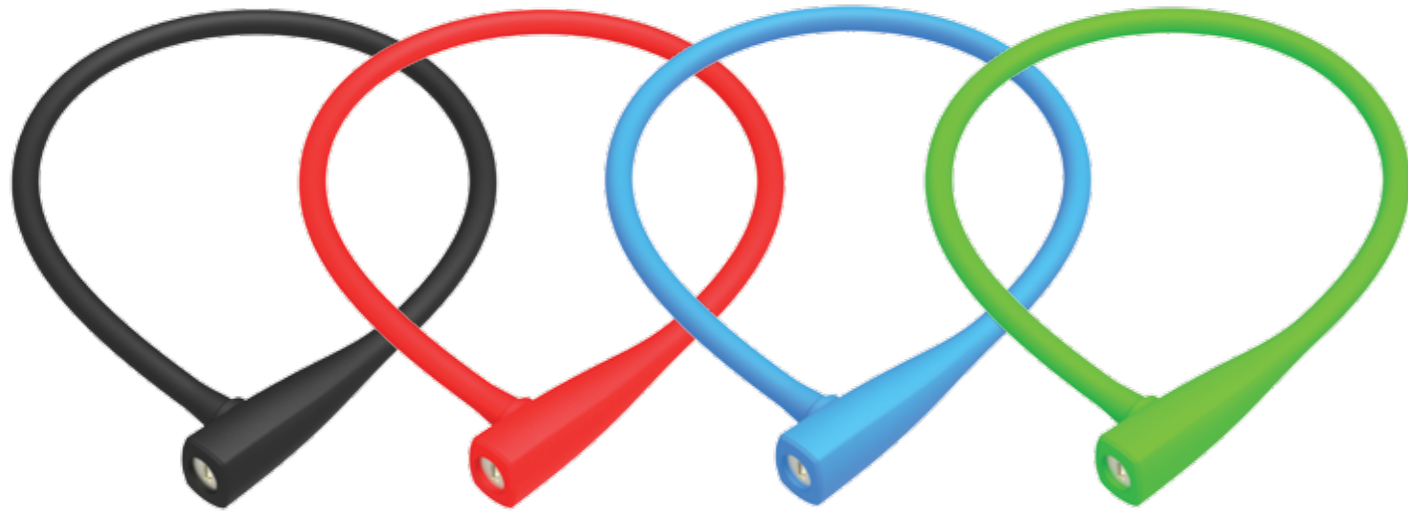

Rubberman Key Cable Lock | 8207

Cable: 75cm x 12mm (2.46' x 0.47")
Color: black
2 keys included

Rubberman Key Cable Lock | 8208

Cable: 75cm x 12mm (2.46' x 0.47")
Color: red
2 keys included

Rubberman Key Cable Lock | 8209

Cable: 75cm x 12mm (2.46' x 0.47")
Color: blue
2 keys included

Rubberman Key Cable Lock | 8210

Cable: 75cm x 12mm (2.46' x 0.47")
Color: green
2 keys included

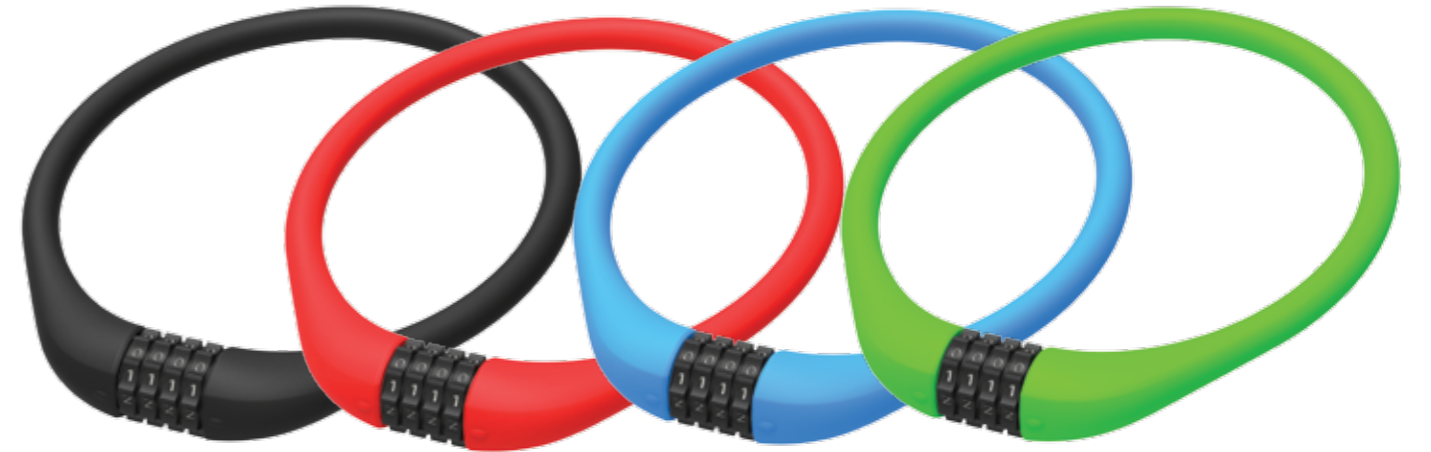

Rubberman Combo Cable Lock | 8211

Cable: 75cm x 12mm (2.46' x 0.47")
Color: black

Rubberman Combo Cable Lock | 8212

Cable: 75cm x 12mm (2.46' x 0.47")
Color: red

Rubberman Combo Cable Lock | 8213

Cable: 75cm x 12mm (2.46' x 0.47")
Color: blue

Rubberman Combo Cable Lock | 8214

Cable: 75cm x 12mm (2.46' x 0.47")
Color: green



Rubberman Key Coil Cable Lock | 8215

Cable: 75cm x 12mm (2.46' x 0.47")
Color: black
2 keys included

Rubberman Key Coil Cable Lock | 8216

Cable: 75cm x 12mm (2.46' x 0.47")
Color: red
2 keys included

Rubberman Key Coil Cable Lock | 8217

Cable: 75cm x 12mm (2.46' x 0.47")
Color: blue
2 keys included

Rubberman Key Coil Cable Lock | 8218

Cable: 75cm x 12mm (2.46' x 0.47")
Color: green
2 keys included

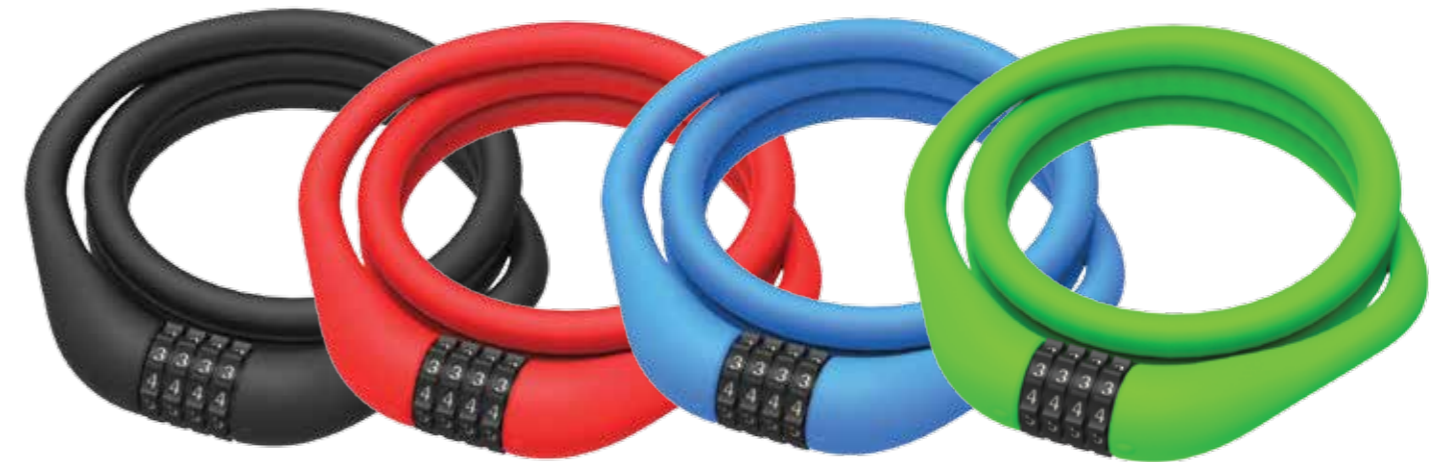

Rubberman Combo Coil Cable Lock | 8219

Cable: 75cm x 12mm (2.46' x 0.47")
Color: black

Rubberman Combo Coil Cable Lock | 8220

Cable: 75cm x 12mm (2.46' x 0.47")
Color: red

Rubberman Combo Coil Cable Lock | 8221

Cable: 75cm x 12mm (2.46' x 0.47")
Color: blue

Rubberman Combo Coil Cable Lock | 8222

Cable: 75cm x 12mm (2.46' x 0.47")
Color: green

Smart Alarm Disc Locks provide motorcyclists and other power sports users outstanding security in a small convenient size. Stapler and pin type models offer great protection against drive off thefts and easily fit in a pocket or tank bag. Most disc locks come with carrying case and disc reminder cable to prevent accidental drive aways.

Alarm Disc Locks feature:

- Double Locking System
- Ice Spray-Proof Body & Key Barrel
- 10-14mm Carbide-Reinforced Locking Pin
- 120dB Alarm
- Auto Arm/Disarm
- Shock & Movement Sensors



ADDITIONAL FEATURES



5 laser cut keys
(1 micro-light and 4 extra grip keys)
Micro-light key projects a bright white beam



Carrying pouch with belt clip and disc reminder prevents riding away while disc lock is still engaged

ANTI-THEFT PROTECTION OFFER for power sport \$751



Smart Alarm Disc Lock | 8246
Pin Dimensions: 10mm (0.39"),
Hardened Steel
black



Smart Alarm Disc Lock | 8251
Pin Dimensions: 14mm (0.55"),
Hardened Steel
black



Smart Alarm Disc Lock | 8256
Pin Dimensions: 6mm (0.24"),
Hardened Steel
black



Smart Alarm Disc Lock | 8261
Pin Dimensions: 10mm (0.39"),
Hardened Steel
black



Smart Alarm Disc Lock | 8247
Pin Dimensions: 10mm (0.39"),
Hardened Steel
red



Smart Alarm Disc Lock | 8252
Pin Dimensions: 14mm (0.55"),
Hardened Steel
red



Smart Alarm Disc Lock | 8257
Pin Dimensions: 6mm (0.24"),
Hardened Steel
red



SMART ALARM DISC LOCK | 8262
Pin Dimensions: 10mm (0.39"),
Hardened Steel
red



Smart Alarm Disc Lock | 8248
Pin Dimensions: 10mm (0.39"),
Hardened Steel
yellow



Smart Alarm Disc Lock | 8253
Pin Dimensions: 14mm (0.55"),
Hardened Steel
yellow



Smart Alarm Disc Lock | 8258
Pin Dimensions: 6mm (0.24"),
Hardened Steel
yellow



Smart Alarm Disc Lock | 8263
Pin Dimensions: 10mm (0.39"),
Hardened Steel
yellow



Smart Alarm Disc Lock | 8249
Pin Dimensions: 10mm (0.39"),
Hardened Steel
silver



Smart Alarm Disc Lock | 8254
Pin Dimensions: 14mm (0.55"),
Hardened Steel
silver



Smart Alarm Disc Lock | 8259
Pin Dimensions: 6mm (0.24"),
Hardened Steel
silver



Smart Alarm Disc Lock | 8264
Pin Dimensions: 10mm (0.39"),
Hardened Steel
silver



Smart Alarm Disc Lock | 8250
Pin Dimensions: 10mm (0.39"),
Hardened Steel
gold



Smart Alarm Disc Lock | 8255
Pin Dimensions: 14mm (0.55"),
Hardened Steel
gold



Smart Alarm Disc Lock | 8260
Pin Dimensions: 6mm (0.24"),
Hardened Steel
gold



Smart Alarm Disc Lock | 8265
Pin Dimensions: 10mm (0.39"),
Hardened Steel
gold

120dB Alarm Disc Locks
Stainless-Steel Mono-Bloc Body

120dB Alarm Disc Locks
Diecast Metal Body

120dB Alarm U-Locks

ANTI-THEFT PROTECTION OFFER for power sport **\$751**

Perfectly suited for cyclists and power sport users, Smart Alarm U-Locks offer our highest level of security in one convenient, easy-to-use design. OnGuard's wide range of shackle lengths, optional cables, pick, pull, bump and drill resistant cylinders.

Alarm U-Locks feature:

- High security locking mechanisms secure both sides of the shackle
- 14-16mm Hardened steel shackles are impervious to prying, jacking, or cutting
- Round profile and smooth edges eliminate leverage points
- Fully coated shackles and crossbar protects delicate finishes and paint jobs
- 120dB Alarm
- Auto Arm/Disarm
- Shock & Movement Sensors

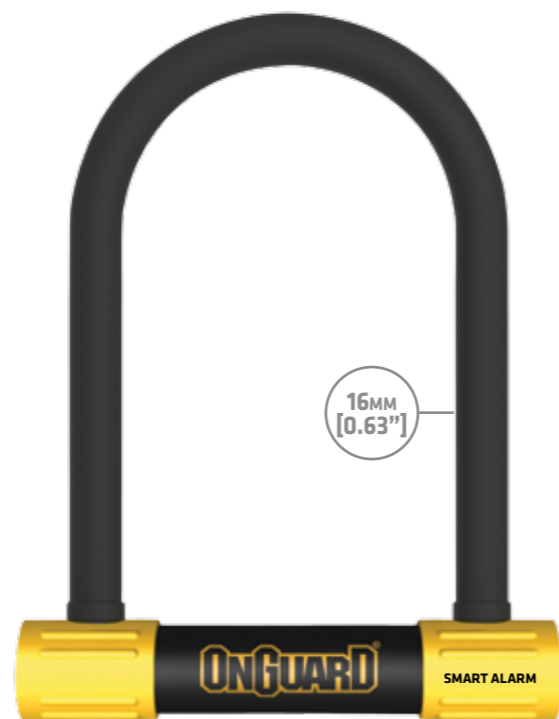

16MM [0.63"]



Smart Alarm U-Lock | 8266

Shackle Dimensions: 124mm x 208mm (4.88" x 8.19") x 16mm (0.63") D



ADDITIONAL FEATURES



Snap Lock Quick Release multi-position mounting bracket



5 laser cut keys (1 micro-light and 4 extra grip keys) Micro-light key projects a bright white beam



14MM [0.55"]



Smart Alarm U-Lock | 8267

Shackle Dimensions: 85mm x 150mm (3.35" x 5.91") x 14mm (0.55") D

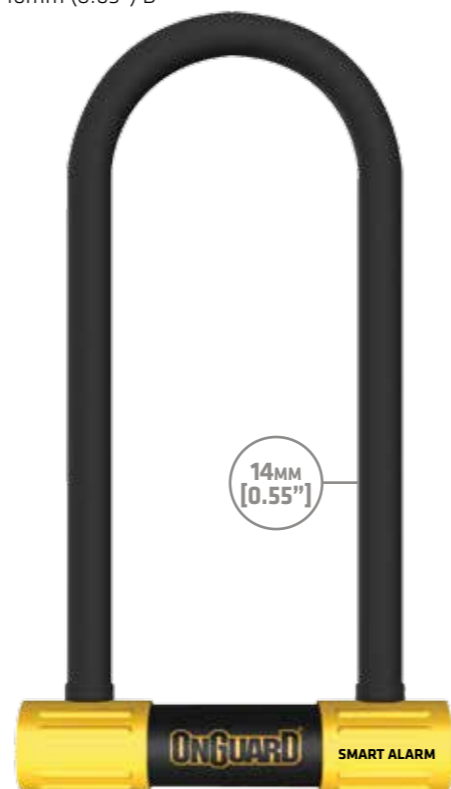

14MM [0.55"]



Smart Alarm U-Lock | 8268

Shackle Dimensions: 100mm x 258mm (3.94" x 10.16") x 14mm (0.55") D

Solo Chains

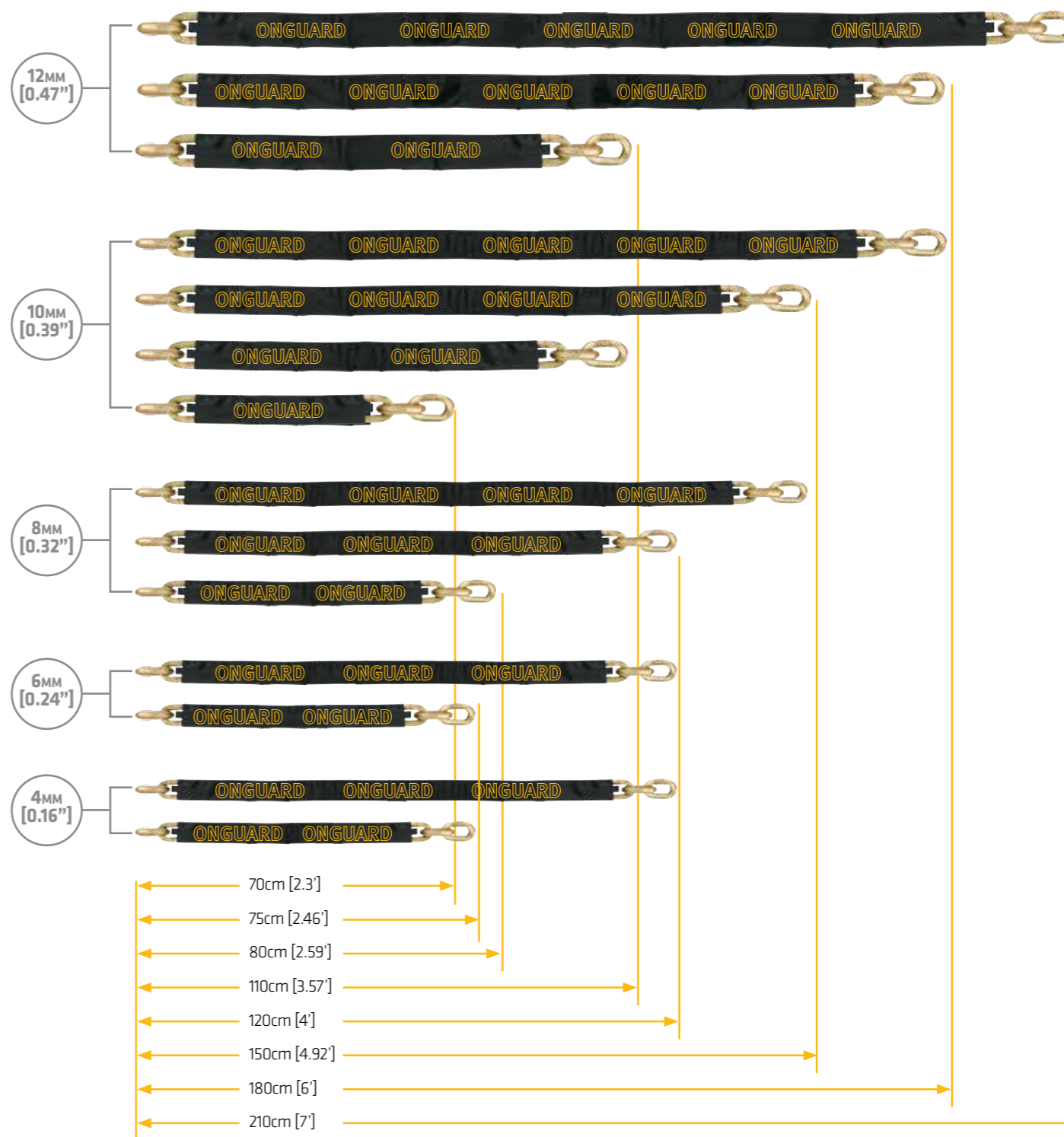

Beast Series

Model	Size
8226	110cm x 12mm
8227	180cm x 12mm
8228	210cm x 12mm

Mastiff Series

Model	Size	Model	Size	Model	Size
8229	70cm x 10mm	8233	80cm x 8mm	8236	75cm x 6mm
8230	110cm x 10mm	8234	120cm x 8mm	8237	120cm x 6mm
8231	150cm x 10mm	8235	150cm x 8mm	8238	75cm x 4mm
8232	180cm x 10mm			8239	120cm x 4mm

ONGUARD FLOOR DISPLAY

Great addition to any shop. Dedicated floor space for your customer's favorite security brand. Adaptable to fit all OnGuard products. Can be used back-to-back to create an OnGuard super center. Hooks can be positioned individually and on both sides (25 hooks included). Easy to set up, as parts are mostly pre-assembled.

Slat Wall Sign Holder 8"x24"

- Hold OnGuard signs on standard slat wall
- One sign holder will hold 8"x24" sign, two signs holders will hold 8"x48" sign
- Includes two slat wall mounting hooks
- Easy to set up

Slat Wall Sign Holder 6"x24"

- Hold OnGuard signs on standard slat wall
- One sign holder will hold 6"x24" sign
- Includes two slat wall mounting hooks
- Easy to set up

ONGUARD 8"x48" SIGN

- Slides on two OnGuard 8"x24" slat wall sign holder

ONGUARD 8"x24" SIGN

- Slides on both sides of OnGuard free standing display and on OnGuard 8"x24" slat wall sign holder

ONGUARD 6"x24" SIGN

- Slides on OnGuard 6"x24" slat wall sign holder

ONGUARD 6"x12" SIGN

- Slides on OnGuard 6"x12" slat wall sign holder

Slat Wall Sign Holder

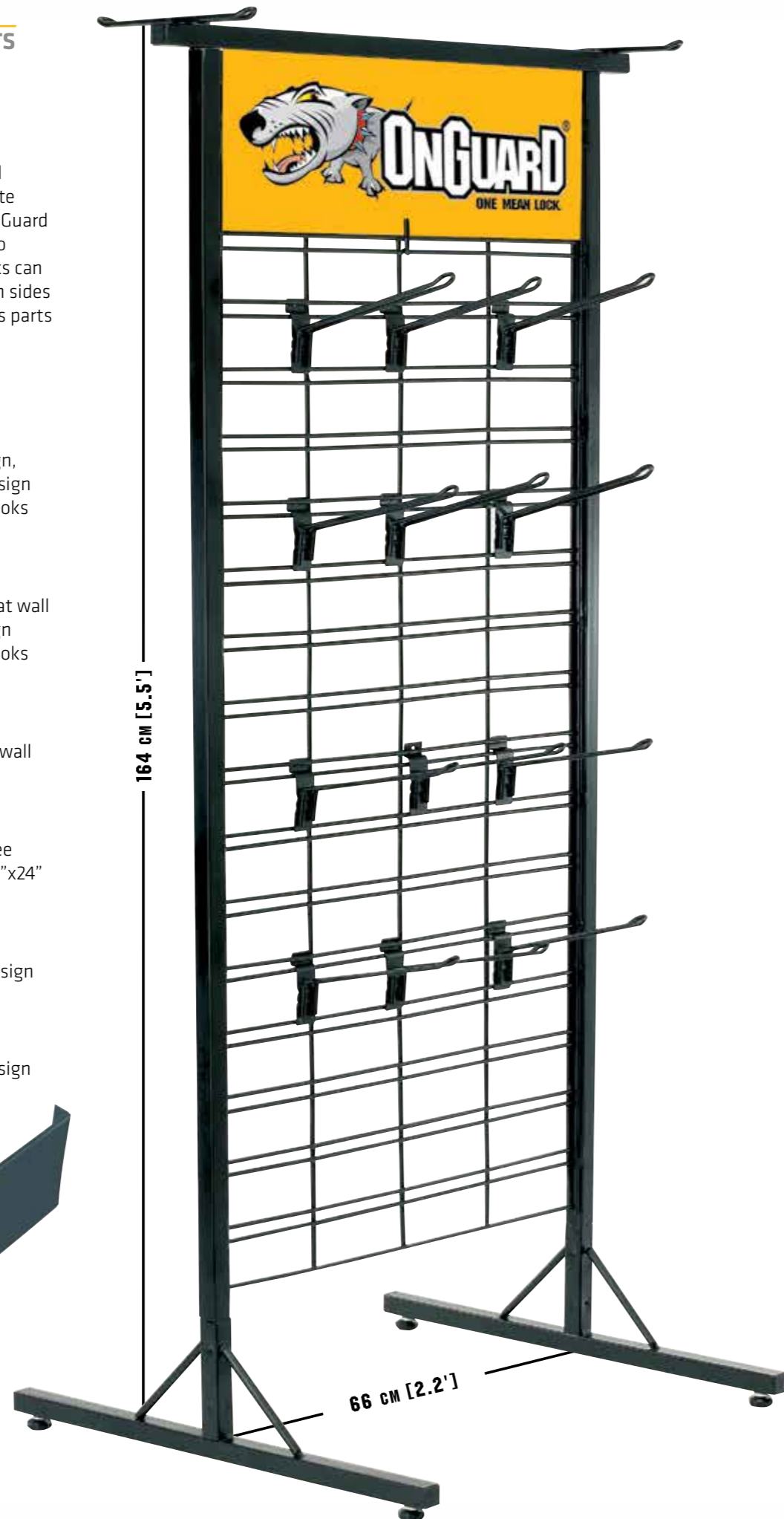
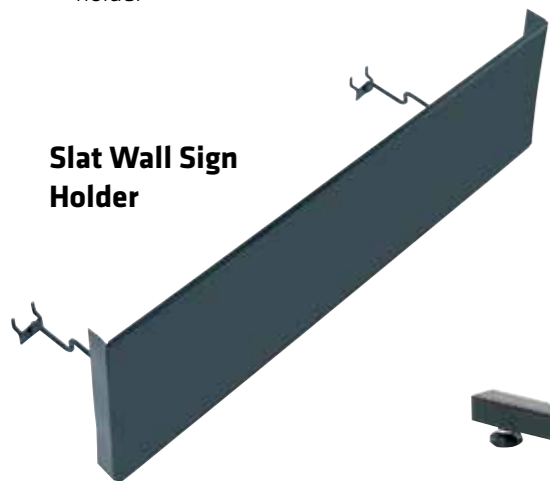

ANTI-THEFT PROTECTION OFFER

Anti-theft protection available on all noted U-locks, chains and disc locks for up to three years of coverage. Provides protection and replacement of your bicycle or powersport vehicle up to the designated dollar amount should our product fail when used properly.

LIFETIME WARRANTY

All of our products are warranted to be free from mechanical defects for the lifetime of the product. If a mechanical defect occurs, we'll replace the product - free of charge.



We include 4 keys and 1 Microlight key for night-time use with most of our key locks.



Register your Z-Cylinder key code. If you lose your keys and you have registered them, or know your key number, replacement keys can be sent to you for a minimal fee.



Most OnGuard locks can be keyed alike to each other as well as keyed alike to other OnGuard models that feature the Z-Cylinder™.

ONGUARD SECURITY RATING



Basic Security

This level offers basic theft resistance. Best used in low crime areas, suburban, recreational and rural areas. A quick way to secure your power sport when theft threat is low.



High Security

This level offers high theft resistance. Best used in high crime areas, campuses, suburban and recreational areas. This is a very high level of protection.



Ultimate Security

This level offers the ultimate theft resistance. Best used in major cities, top crime areas, downtown, campuses and urban areas where crime is high. This is your best defense.

Our products have been tested, approved and certified by the most important European test organizations that are dedicated to performing the harshest tests imaginable on locks. And the test results speak for themselves.





ONGUARD[®]
onguardlock.com

POWERED BY



**Todson Inc. 4 Cocasset Street
Foxborough, MA 02035
www.todson.com**

Phone: (774) 306-3521, (800) 213-4561

Fax: (774) 306-3295, (800) 341-3013