

592039

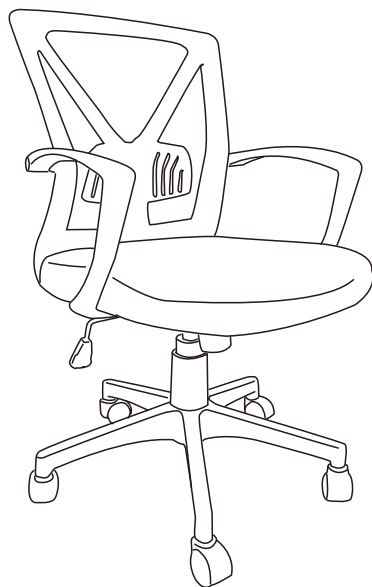

- EN** - Please read this instruction manual carefully before attempting to install.  
**DE** - Bitte lesen Sie diese Bedienungsanleitung vor der Montage gründlich durch.  
**ES** - Por favor lea con atención el manual de instrucciones antes de llevar a cabo el ensamble.  
**FR** - Lisez attentivement cette notice avant de commencer le montage.  
**IT** - Si prega di consultare il libretto delle istruzioni prima del montaggio.

# IMPORTANT/WICHTIG/ATENCIÓN

## IMPORTANT/IMPORTANTE



EN - We recommend **2** or more people to install.  
DE - Wir empfehlen, dass die Montage von **2** oder mehreren Personen durchgeführt werden sollte.  
ES - Recomendamos realizar el ensamble con **2** o más personas.  
FR - Il est recommandé d'effectuer le montage à **2** personne(s) ou plus.  
IT - È necessaria la presenza di **2** o più persone per il montaggio di questo prodotto.



EN - The expected assembly time is **0.5** h.  
DE - Die Montagezeit beträgt durchschnittlich **0.5** h.  
ES - El tiempo aproximado de ensamble es de **0.5** h.  
FR - Le temps nécessaire est estimé à **0.5** h.  
IT - Il tempo previsto per il corretto assemblaggio è di **0.5** h.



EN - Not intended for use by children.  
DE - Nicht geeignet für Kinder.  
ES - Producto no apto para niños.  
FR - Produit non destiné à être utilisé par des enfants.  
IT - Questo prodotto non è destinato all'uso da parte dei bambini.



EN - Keep away from fire or other heat sources.  
DE - Bitte von Feuer und Hitzequellen fernhalten.  
ES - Manténgase alejado de las llamas y otras fuentes de calor.  
FR - Tenir à distance des flammes et autres sources de chaleur.  
IT - Tenere lontano dal fuoco o da altre fonti di calore.



EN - We recommend wearing protective gloves.  
DE - Wir empfehlen das Tragen von Schutzhandschuhen.  
ES - Recomendamos el uso de guantes de seguridad.  
FR - Il est recommandé de porter des gants de protection.  
IT - Per il processo di assemblaggio, consigliamo fortemente l'utilizzo di guanti protettivi.



EN - Please contact us via **help@yaheetech.shop** if you need assistance.  
DE - Bitte kontaktieren Sie unseren Kundenservice per E-Mail: **help@yaheetech.shop** für weitere Hilfe.  
ES - Si necesita ayuda, por favor póngase en contacto con nosotros a través de **help@yaheetech.shop**.  
FR - Besoin d'aide? Contactez-nous via **help@yaheetech.shop**.  
IT - Per assistenza o maggiori informazioni, puoi contattarci all'indirizzo mail **help@yaheetech.shop**.

**EN** - Please follow the instruction manuals and use a pad to avoid damage during assembly.









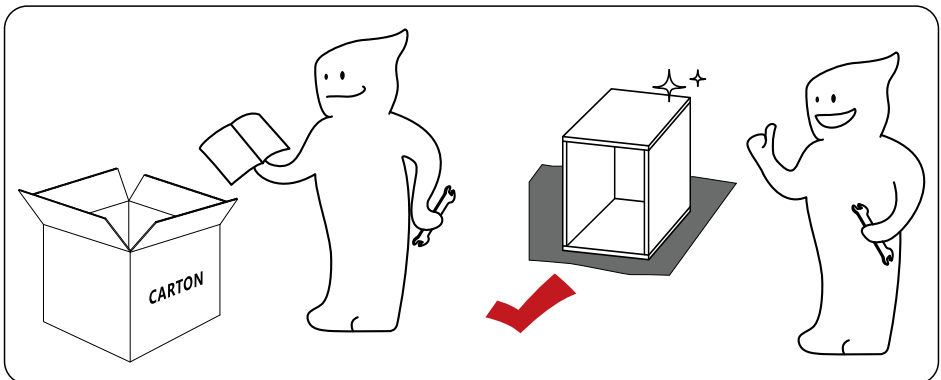
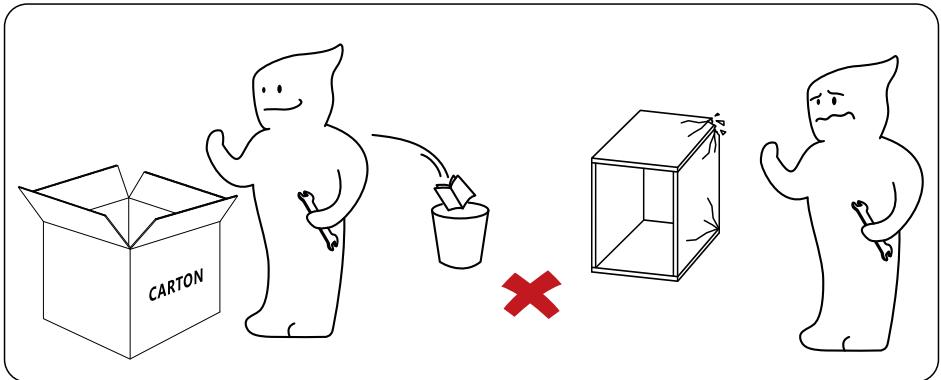

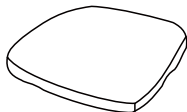
**DE** - Bitte folgen Sie der Anleitung und verwenden Sie eine Unterlage, um Beschädigungen bei der Montage zu vermeiden.

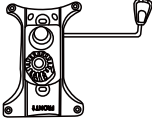
**ES** - Por favor siga las instrucciones del manual y utilice una cubierta o lona para proteger el producto y los suelos durante la instalación.

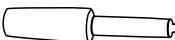

**FR** - Suivez les instructions de la notice et utilisez une couverture ou une bâche pour protéger le produit et les sols pendant le montage.

**IT** - Si prega di consultare il manuale illustrativo durante il montaggio e di utilizzare un cuscinetto per evitare possibili danni.





<p>Ⓐ × 1</p> 	<p>Ⓑ × 1</p> 	<p>Ⓒ × 1 <b>R</b></p> 	<p>Ⓓ × 1 <b>L</b></p> 
<p>Ⓔ × 1</p> 	<p>Ⓕ × 1</p> 	<p>Ⓖ × 1</p> 	<p>Ⓗ × 5</p> 
<p>Ⓘ × 1</p> 	<p>Ⓙ × 4</p> 	<p>Ⓚ × 10</p> 	<p>Ⓛ × 12</p> 
<p>Ⓜ × 1</p> 			

1

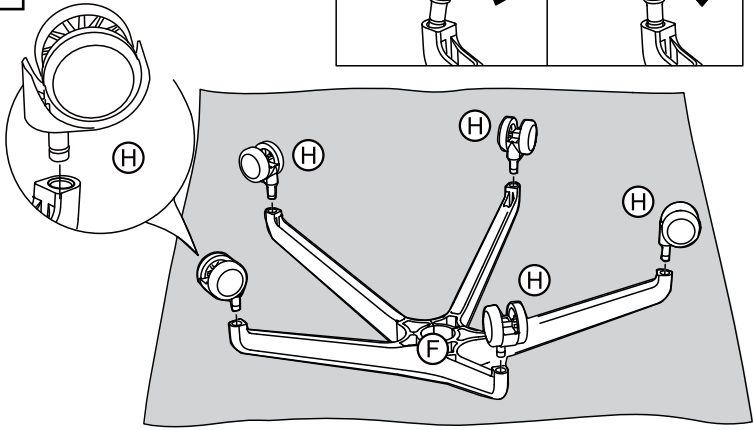
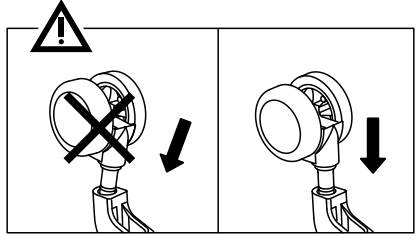
F		x1
H		x5





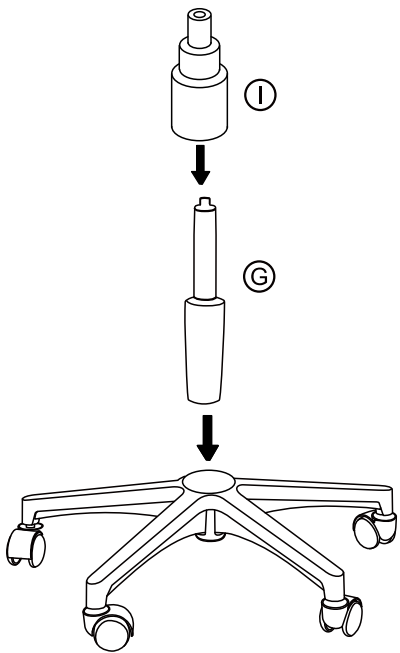

2

G		x1
I		x1



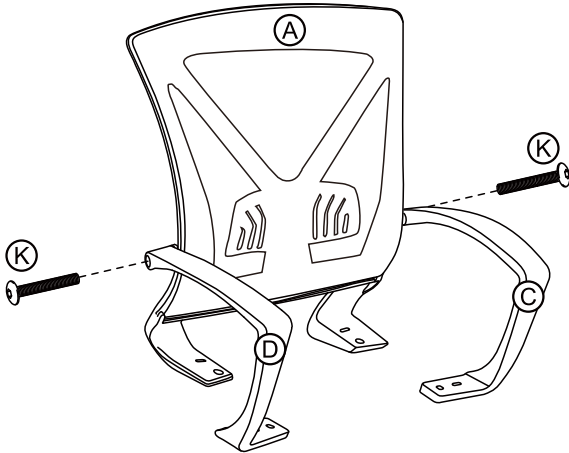

3

(A)		x1
(C)		x1
(D)		x1
(K)		x2



4

(B)		x1
(K)		x8
(L)		x8

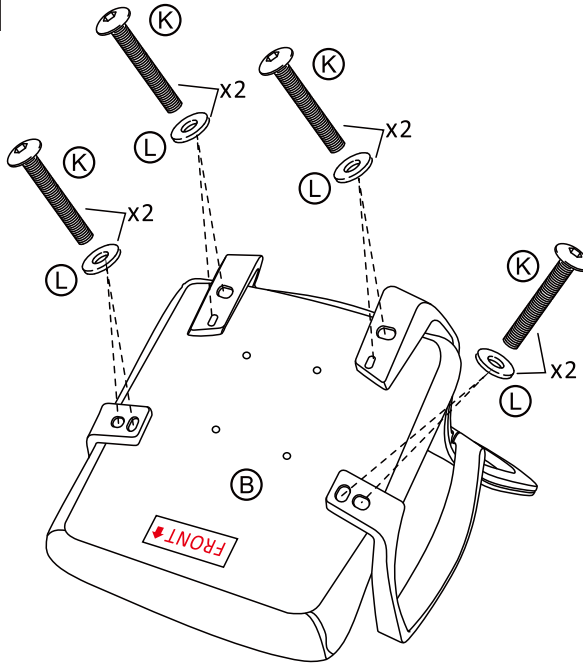

**EN** - During the assembly, please first half-tighten all the screws into the holes. After all the screws are set, fully tighten them.



**DE** - Bei der Montage ziehen Sie bitte zuerst alle Schrauben leicht von Hand fest. Erst nachdem alle Schrauben eingedreht sind, ziehen Sie diese dann vollständig mit dem Inbusschlüssel fest.

**ES** - Durante el montaje, apriete todos los tornillos sólo hasta la mitad. después de insertar todos los tornillos, apriételes completamente.

**FR** - Pendant le montage, il est recommandé de ne serrer les vis qu'à demi. Ne vissez à fond qu'une fois toutes les vis insérées.

**IT** - Durante il montaggio, si prega di stringere tutte le viti solo a metà. Solamente dopo aver inserito tutte le viti, stringerle completamente.

5

E	 x1
J	 x4
L	 x4

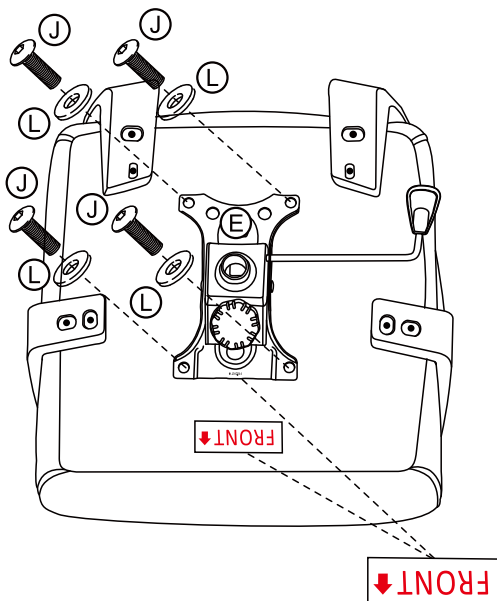

- EN** - During the assembly, please first half-tighten all the screws into the holes. After all the screws are set, fully tighten them.
- DE** - Bei der Montage ziehen Sie bitte zuerst alle Schrauben leicht von Hand fest. Erst nachdem alle Schrauben eingedreht sind, ziehen Sie diese dann vollständig mit dem Inbusschlüssel fest.
- ES** - Durante el montaje, apriete todos los tornillos sólo hasta la mitad. después de insertar los tornillos, apriételes completamente.
- FR** - Pendant le montage, il est recommandé de ne serrer les vis qu'à demi. Ne vissez à fond qu'une fois toutes les vis insérées.
- IT** - Durante il montaggio, si prega di stringere tutte le viti solo a metà. Solamente dopo aver inserito tutte le viti, stringerle completamente.

6

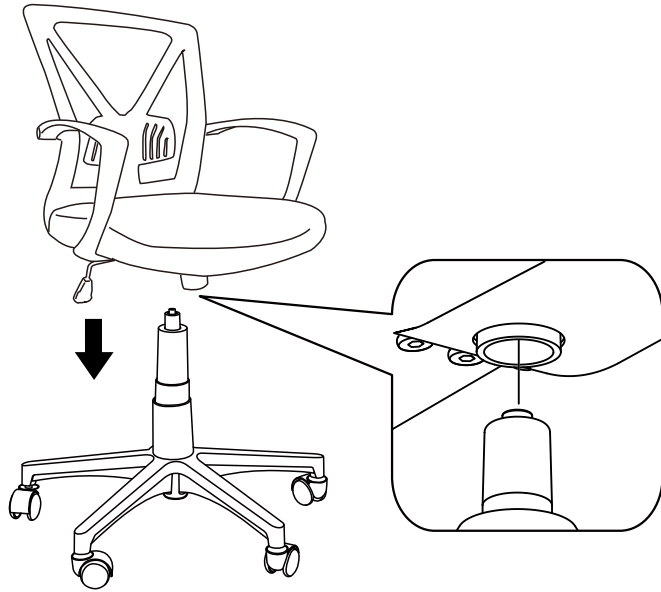

7

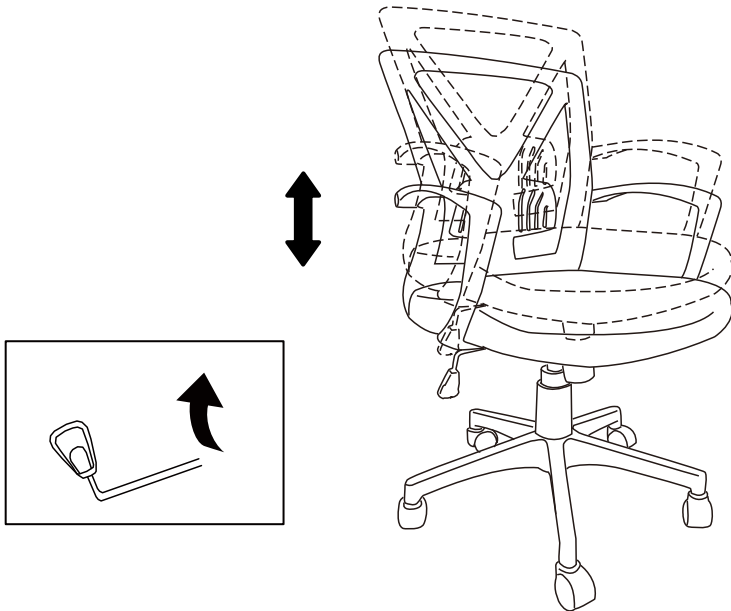

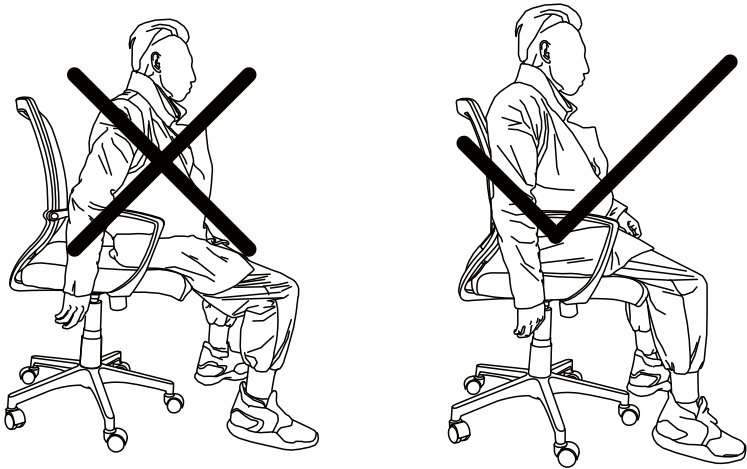

**EN - Note:**When lowering down the seat height, please make sure to fully sit on the seat (as the right figure shows below) in order to give it enough pressure.

**DE - Hinweis:**Achten Sie bitte darauf, dass Sie beim Absenkvorgang der Sitzhöhe vollständig auf den Sitz sitzen (wie auf der nachfolgenden rechten Abbildung gezeigt), um genügenden Druck auf die Gasdruckfeder auszuüben.

**ES - Nota :** Cuando baje la altura del asiento, asegúrese de sentarse completamente en el asiento (como muestra la figura de la derecha) para ejercer suficiente presión.

**FR - NB :** Pour abaisser la hauteur du siège, veuillez à bien vous asseoir au fond (comme sur l'image de droite) afin d'exercer une pression suffisante.

**IT - Nota:**Prima di abbassare l'altezza del sedile, assicurarsi di sedersi correttamente (come mostrato dall'immagine) in modo che la pressione sia sufficiente.

EN



**Good job.** Would you like to share your experience to assist others with their shopping decisions?



**Not good.** If you are not satisfied with this shopping experience, please contact us via [help@yaheetech.shop](mailto:help@yaheetech.shop).

DE



**Gut.** Wollen Sie Ihre Erfahrungen teilen, um anderen Kunden bei ihrer Kaufentscheidung zu helfen?



**Nicht gut.** Wenn Sie mit diesem Einkaufserlebnis nicht zufrieden sind, kontaktieren Sie unseren Kundenservice per E-Mail: [help@yaheetech.shop](mailto:help@yaheetech.shop) für weitere Hilfe.



Hergestellt in PRC für Yahee GmbH

Importeur: Yahee GmbH

Hans-Grüninger-Weg 11

71706 Markgröningen

Willkommen auf unserer Webseite, Web: [www.yaheetech.de](http://www.yaheetech.de)

ES



**Satisfecho.** ¿Le gustaría compartir su experiencia para ayudar a otros clientes en su compra?



**Insatisfecho.** Si no está satisfecho con su compra, póngase en contacto con nosotros a través de [help@yaheetech.shop](mailto:help@yaheetech.shop).

FR



**Satisfait.** Souhaitez-vous partager votre expérience pour aider d'autres potentiels clients dans leur choix ?



**Mécontent.** Si vous n'êtes pas satisfait de votre achat, contactez-nous via [help@yaheetech.shop](mailto:help@yaheetech.shop).

IT



**Soddisfatto.** Ti piacerebbe condividere la tua esperienza con gli altri utenti?



**Insoddisfatto.** Se non sei soddisfatto della tua esperienza, si prega di contattarci all'indirizzo mail: [help@yaheetech.shop](mailto:help@yaheetech.shop).

EN - You can also get a downloadable user manual by scanning the QR code below.

DE - Sie können auch ein herunterladbares Benutzerhandbuch erhalten, indem Sie den QR-Code unten scannen.

ES - Puede descargar una versión digital escaneando el siguiente código QR.

FR - Vous pouvez télécharger une version digitale en scannant le code QR ci-dessous.

IT - Puoi scaricare il libretto delle istruzioni scannerizzando il codice QR in fondo alla pagina.



592039

[www.yaheeshop.com/pdf/all-1-5012424.pdf](http://www.yaheeshop.com/pdf/all-1-5012424.pdf)