

## SPECIFICATIONS

<b>Description</b>	Professional Ultrasonic Cleaner	
<b>Model</b>	P4821	
<b>Tank Capacity</b>	2500 ml / 2.6 Qt (US)	Max. 2100 ml / 2.2 Qt (US)
		Min. 600 ml / 0.6 Qt (US)
<b>Tank Size</b>	24.5 x 15.0 x 7.6 cm / 9.6" x 5.9" x 3.0"	
<b>Longest Item Fits inside Tank</b>	26.0 cm / 10.2"	
<b>Power Supply</b>	160 W ( AC 100~120V 50/60Hz)	
	170 W (AC 220~240V 50/60Hz)	
	130 W (AC 100V 50/60Hz)	
<b>Digital Timer Settings</b>	1 to 30-minute full range timer	
<b>Ultrasonic Frequency</b>	35,000 Hz	
<b>Tank Material</b>	Stainless Steel SUS304	
<b>Housing Material</b>	ABS	
<b>Net Weight</b>	2.9 kg / 6.4 lb	
<b>Gross Weight</b>	3.5 kg / 7.7 lb	
<b>Unit Size</b>	31.4 x 24.3 x 20.4cm / 12.4" x 9.6" x 8.0"	
<b>Inner Carton Size</b>	35.6 x 27.5 x 24.2 cm / 14.0" x 10.8" x 9.5"	
<b>Qty per Master Carton</b>	4 pcs /ctn	
<b>Master Carton Size</b>	57.0 x 37.5 x 51.5 cm / 22.4" x 14.8" x 20.1"	

### Warranty

This base unit carries one-year warranty for parts and labor for quality defects. Accessories such as the basket or the beakers are not covered by the warranty. Damages caused by misuse or careless uses of the unit are not covered. Customer is responsible for shipping both ways outside of the continental USA and one way within the continental USA. Contact us first, then send the unit with a copy of the original invoice or receipt back To register for warranty, email the receipt and the serial number to [warranty@isonicinc.com](mailto:warranty@isonicinc.com).



iSonic Inc.  
2243 S. Throop St. Chicago, IL 60608 USA  
Tel: +1-847-850-0404 [info@isonicinc.com](mailto:info@isonicinc.com)  
[www.isonicinc.com](http://www.isonicinc.com)



© iSonic Inc. v. 20200407

# ISONIC®

## P4821 PROFESSIONAL ULTRASONIC CLEANER

### USER MANUAL

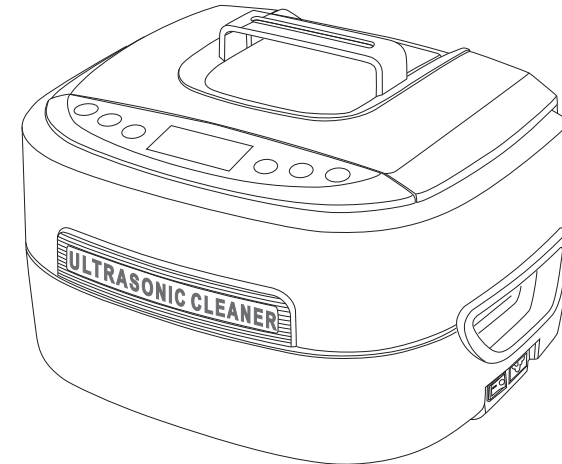

### FEATURES

- 1 Lengthened tank** Tank capacity: 2500 ml / 2.6 Qt; Size 24.5x15.0x7.6 cm / 9.6"x5.9"x3.0". Longest item that can fit is 26.0 cm / 10.2"
- 2 Control panel with capacitive sensing technology** Durable, reliable, resistant to water and harsh chemicals
- 3 Industrial ultrasonic transducer** Ø38mm industrial transducer(60W),with stronger cleaning effect
- 4 2-color LED display** 1 to 30-minute full range timer, degas feature
- 5 Ceramic heater** 100W ceramic heater, temperature preset at 60°C (140°F)
- 6 Multiple circuit protectors** When overloaded or improperly used, the protectors shut down the power to certain areas to protect the machine
- 7 Cooling fan** Improves heat dissipation and beneficial for continuous operations
- 8 Detachable power cord** Independent power switch and detachable power cord, convenient to use
- 9 Moisture-proofed PCB and industrial grade IC** Capable for different working environment with better anti-interference performance
- 10 Engineering grade plastics** 4mm wall thickness with tongue and groove joints, with better impact and water-proof performances



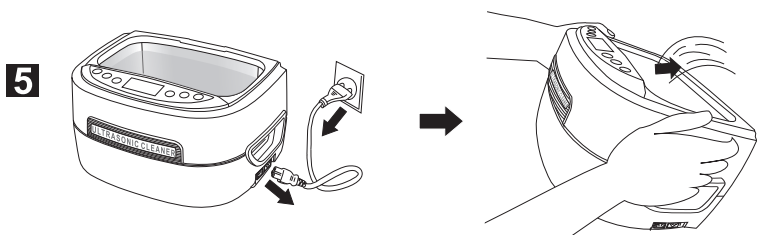

Once cleaning is done, unplug the power cord, pour water out from the rear left corner quickly so water will not drip over the housing.

## CARE AND MAINTENANCE

### Do not turn on the unit without water in the tank.

Even though the unit is designed with multiple protections, if it is turned on for over 30 seconds without water in the tank, it may damage the unit or severely reduce the life of the unit. If the heater is turned on over 10-20 seconds without water in the tank, it will be damaged.

**!** This unit is equipped with a thermal cutoff. If the cleaning function is turned on without water in the tank, the temperature will rise continuously. The thermal cutoff will be actuated after approximately 15 minutes to ensure safety. The unit will be disabled until it's repaired.

### Do not run the unit for extended time or continuously.

The unit is designed with overheat protection. If the unit has been running for 30 minutes, it is recommended to stop the unit for about 20 minutes to prolong the life of the unit.

### Do not keep water in the cleaning tank for a long time.

After cleaning is completed, turn off the switch then pour water out through the pouring recess or rear left corner. Pour it quickly so water will not drip over the housing. Avoid getting water inside the housing through the vents and causing damage. Do not pour water over the power cord or the control panel. Be careful not to drop the unit when pouring water out.

### Do not spray water over the housing.

Use a towel to wipe the tank and the housing.

### Do not expose the unit under direct sunshine for long.

Keep the unit in a dry, cool and ventilated area.

### Add enough water to submerge the items and to be higher than the minimum depth but below the maximum. The optimum range is half tank to 3/4 full.

### Do not use flammable or ammoniated liquid, corrosive solutions including paint thinners, liquid bleaches in the tank as they may ignite and/or cause injury, damage to your unit, and void the warranty.

### Avoid using distilled water or reverse osmosis water alone as they could aggressively corrode metal including stainless steel.

### Avoid getting water inside the housing or onto the control panel. Do not use wet hand to touch the control panel.

### A basket or extra items, especially soft items, can reduce cleaning effect.

### Change water/solution frequently. Wipe the tank clean after use each time.

### Unplug the electrical cord before emptying and cleaning the tank and when not in use, or switch off the power.

### Retain the packing carton for storage or service.

## INTRODUCTION

**Use tap water. Special solutions are not necessary in most cases.**

### Principles of ultrasonic cleaning:

Millions of tiny air bubbles are generated within liquid by high frequency vibration. The air bubbles burst when in contact with object and dislodge the debris to achieve the cleaning effect.

- !** Using tap water is sufficient. Purified water or distilled water has the same cleaning effect as regular tap water for ultrasonic cleaning.
- Avoid using highly purified water or reverse osmosis water alone as they could aggressively corrode metal including stainless steel.
- When cleaning silver or copper items where oxidation has darkened the items, special solutions needs to be added to the water to remove the oxidation.

### Main Features

- Tank capacity: 2500 ml / 2.6 Qt . Size: 24.5x15.0x7.6 cm / 9.6"x5.9"x3.0". Longest item that can fit inside the tank is 26.0 cm / 10.2".
- Powerful industrial grade  $\Phi$ 38 ultrasonic transducer (60 W), much better cleaning effect than wafer transducers.
- Control panel with capacitive sensing technology: Durable, reliable, resistant to water and harsh chemicals .
- Ceramic heater (about 100 W), temperature preset at 60°C
- 2-color LED display. 1 to 30-minute full range timer. Degas feature.
- Industrial grade IC. Moisture-proofed PCB. Cooling fan. Thermal cutoff, overheat protector, internal safety timer for heater. Improved product durability.
- 4 mm wall thickness with tongue and groove joints for better impact and water-proof performances.

### Read the Manual First

The manual should be carefully reviewed before starting to use the device. Warnings should be observed carefully. Please follow the manual for operations.

## TABLE OF CONTENTS

Safety Precautions -----	1,2
Items Not Suitable for Ultrasonic Cleaning -----	2
Applications -----	3,4,5
Sample Applications -----	5,6
Product Explosion Picture -----	7,8
Product Structure and Accessories-----	9
Control Panel and Operations -----	10
Common Cleaning Methods -----	11,12,13
Operation Guidelines -----	14,15
Care and Maintenance -----	15
Specifications -----	16

## SAFETY PRECAUTIONS

### Keep it away from children!

- Please store the ultrasonic cleaner where it is not reachable by children.
- Danger to children! Danger for death through suffocation! Keep the packaging material away from children.
- This appliance shall not be used by children. Keep the appliance and its cord out of reach of children.

### To prevent life-threatening electrical shock, please observe the following:

#### **Danger of electrical shock!** Do not use while bathing. Never immerse the device or the power cord in water or other liquid.

- **Danger of electrical shock!** Never touch the power plug with wet hands, especially when inserting or removing the plug.
- **Danger of electrical shock!** If the unit has fallen into water during operation, do not touch the unit. Remove the power plug from the socket first.
- **Danger of electrical shock!** Do not spray water or liquid over the device.
- Never operate the device unattended.
- Follow the manual to operate the device.
- Do not use components unapproved by the manufacturer.
- When removing the power cord from the socket, grab the power plug not the cord.
- To protect the power cord from damage, do not cause it to get caught by things such as a cupboard door or a chair leg; do not drag across a hot surface.
- If there is damage to the power plug, cord, housing, or other parts of the device, do not use the device.
- Do not disassemble the device, except by professionals.
- If the unit is damaged, non-operational or has fallen into water, take it to a qualified service provider.
- Remove the power plug from the socket
  - if malfunction occurs
  - before cleaning the device
  - if the device is not going to be used for prolonged period
  - after each use (recommended)
- The installation of an earth leakage circuit breaker with a rated tripping current of no more than 30 mA provides further protection against an electrical shock. The installation should only be carried out by a trained electrician.

### To prevent fire hazards, please observe the following:

- Never block the vents on the device. Keep the vents free from lint, hair and other materials.
- Do not place the device on a soft surface, such as a bed or a couch, where the vents could be blocked.
- Observe the other warnings in the previous section.
- If the supply cord is damaged, it must be replaced by the manufacturer or its service agent or a similarly qualified person in order to avoid a hazard.

## OPERATION GUIDELINES

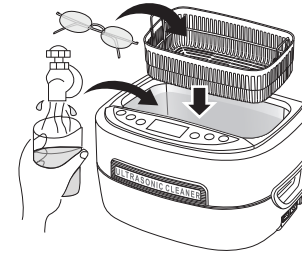

- 1** Remove the lid, put the items in the basket then put them in the cleaning tank. Add water to a level between MIN and MAX and above the area to be cleaned.



If the unit is turned on without water, ultrasonic energy will not be absorbed. Once over 30 seconds, it may damage the unit or severely reduce the life of the unit.

- 2** Connect the power cord to an outlet and turn the switch on. LED display shows . This is the most

commonly used time setting and working state. If the time needs to be adjusted, touch Time+ key and ▼. The time can be set between 1 to 30 minutes. Common cleaning time are 5, 10 or 15 minutes.

Prolonged cleaning time may result in:

- a. Loosening of the screws if used.
- b. Increasing the pre-existing cracks.
- c. Peeling of coating which was already separated.

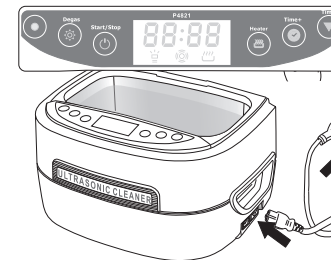

- 3** **Touch Start/Stop key twice to start cleaning.**

To prevent accidental turning on or off the unit, the Start/Stop key needs to be touched twice within 6 seconds to turn it on or off.

During cleaning, buzzing sound can be heard from the cleaning tank, indicating the cleaning is underway. Closing the lid will reduce the noise.

LED display will count down to show the remaining cleaning time. When it displays , the cleaning is done. To stop cleaning at any time, press On/Off button.

The unit is designed with overheating protection to avoid damage caused by extended and continuous operation. When the red light is on, the unit will not turn on even it is forced to. The unit will idle for about 20 minutes then can be restarted after the green light comes on.

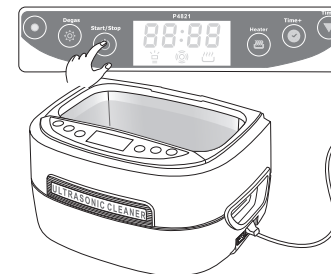

- 4** Select one of the four cleaning methods recommended earlier.

a. When the heater is needed, touch Heater key twice,  flashes, indicating the heater is turned on. When water temperature reaches 60°C (140°F) the heater will be turned off automatically. To prevent accidental turning on or off the heater, the Heater key needs to be touched twice within 6 seconds to turn it on or off.

To ensure safety, the unit is designed with dual protections. The heater will be turned off automatically if it has been running for 45 minutes.

b. To speed up the mixing when solution is used, degas function can be used. Touch Time+ key to set the timer. Touch Degas key,  illuminates. Touch Start/Stop to start degassing. It changes over to normal cleaning after 90 seconds.

c. When debris "cloud" is no longer visible, cleaning is done. If additional cleaning is needed, touch Time+ key to reset the timer and repeat the steps above.

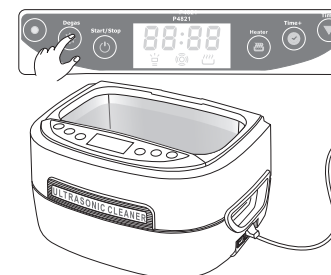

## COMMON CLEANING METHODS

### SPECIAL CLEANING

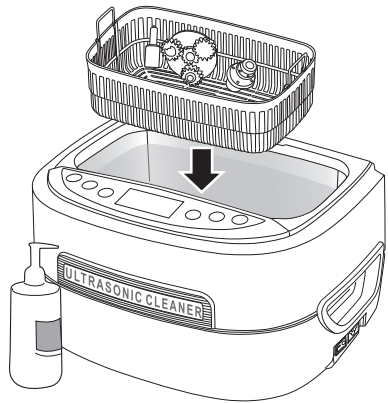

**Applications: To clean items with special solutions. For example, silver, copper or brass items with oxidation which has darkened the items.**

#### Cleaning Method:

1. Put the items in the basket and then in the tank, add water to a level between MIN and MAX and above the area to be cleaned.
2. Add special solution that can remove silver or copper oxidation according to the ratio recommended. Use special solutions according to the instructions for bass cartridges.
3. Touch Heater key twice to turn on the heater if needed, flashes. Touch Heater key twice to cancel heating when the water temperature reaches about 122 °F (50°C) after approximately 30 minutes. dims after the set temperature is reached.)

When the water temperature reaches 140°F (60°C), the heater will turn off automatically. To ensure safety, the heater will also be turned off automatically after being turned on for 45 minutes.

4. Touch Time+ key to set the timer to 5 to 15 minutes.
5. Touch Degas key to select Degas function. illuminates. Touch Start/Stop key twice to start degassing. After 90 seconds, it changes over to normal cleaning.
6. When cleaning is done, remove the basket and the items. If there are large quantities of items and some debris remains, add 5 minutes and repeat the cleaning.
7. Change water and wash the items for 3 minutes to remove the residual chemicals.

Add iSonic Jewelry / Eye Wear Cleaning Solution concentrate #CSGJ01 to remove oily substances such as lotions, human oil, and to make jewelry sparking and eyeglasses crystal clear. Use iSonic Ultrasonic Silver Tarnish Remover #CSST01 to remove silver tarnish. Add iSonic Ultrasonic Brass Cleaning Solution Concentrate #CSBC001 to remove oxidation from brass parts. Add iSonic White Denture Cleaning Powder #CSDW01 to remove stains and buildups from dentures, dental and sleep apnea appliances.

## SAFETY PRECAUTIONS



#### Other observations:

- Do not operate the product without filling the tank with water. Running dry will damage the unit.
- Do not plug in the power cord before adding water to the tank. Do not fill the tank above the Max line to avoid overspill.
- Do not use solution containing abrasive substances or strong corrosive chemical solution not recommended by the manufacturer or the supplier.
- Avoid using distilled water or reverse osmosis water alone as they could aggressively corrode metal including stainless steel.
- Place the device on a dry and flat surface for operation.
- When the device is subjected to severe electromagnetic interference, it may malfunction, stop operating or lose control functions. If this happens, unplug the power cord then reinsert it to restart the device.

## IMPORTANT SAFETY INSTRUCTIONS



#### When using electric appliances, basic precautions should always be followed, including the following :

- Read all the instructions before using the appliance.
- To reduce the risk of injury, close supervision is necessary when an appliance is used near children.
- Only use attachments recommended or sold by the manufacturer.
- Do not use outdoors.
- To disconnect, turn all controls to the off (O) position, then remove plug from outlet. Do not unplug by pulling on cord. To unplug, grasp the plug, not the cord. Unplug from outlet when not in use and before servicing or cleaning. To reduce the risk of electrical shock, do not put the appliance in water or other liquid. Do not place or store appliance where it can fall or be pulled into a tub or sink. All servicing of this product, including transducer replacement, is to be conducted by qualified service personnel. Do not operate any appliance with a damaged cord or plug, or after the appliance malfunctions or is dropped or damaged in any manner. Return appliance to the nearest authorized service facility for examination, repair, or electrical or mechanical adjustment.



### Items Not Suitable for Ultrasonic Cleaning

<b>Soft Jewelry:</b> Pearls, emerald, ivory, coral, agate, sea turtle shells, etc	These items are not hard, so scratches may occur during cleaning.
<b>Welded, Plated and Glued Items:</b> Welded or plated metal items, glued items	Ultrasonic cleaning may enlarge the gaps inside the welded joints, plated coating or glued items and may cause separation.
<b>Watches:</b> Except diver's watches with depth rating over 50 m (150 ft) .	Because the strong penetration capability of the ultrasonic waves, water may get into the watches if they are not truly waterproof. Use the watch stand supplied as a precaution if not sure.
<b>Others:</b> Wood; coated glass, ceramic, camera filters with preexisting cracks; eyeglasses or sunglasses with poor quality coatings.	Ultrasonic cleaning may enlarge the cracks pre-existed in the coating on the glasses, ceramic, and glass. If the items have no pre-existing cracks, then it is okay.

## APPLICATIONS



### Jewelry Stores, Jewelers:

Jewelry stores can use ultrasonic cleaners to expand services. Jewelry such as necklaces, diamond rings, rings and earrings can be cleaned to recover the shine. Jewelry makers can use ultrasonic cleaners to remove debris or abrasive powder from work-in-process items. Jewelry made with investment casting often has wax layer in addition to debris. Turning on the heater will raise the water temperature, melt the wax and improve the cleaning.

### Optical Stores and Labs:

Optical stores can use ultrasonic cleaners to provide valuable services. Use ultrasonic cleaner and tap water to remove the debris between the rim and the lenses so the eyewear gets professional cleaning and care.

Add iSonic Jewelry / Eye Wear Cleaning Solution concentrate #CSGJ01 to remove oily substances such as lotions, human oil, and to make jewelry sparking and eyeglasses crystal clear.

### Biology / Chemical Laboratories:

Labs can use ultrasonic cleaners to clean test tubes, glass or metal containers to remove residual chemicals and materials that can affect the accuracy of the lab tests.

### Dental Clinics:

Dental clinics can use ultrasonic cleaners to clean dental instruments, to remove blood and small particles left on the instruments before disinfection.

Add iSonic DualZyme Dual Enzymatic Ultrasonic Cleaning Tablet #CTDE01 to clean dental and veterinary instruments.

### Homes:

Children and baby items: Debris left in small holes and crevices are difficult to clean by regular means. Bacteria and mold can develop at these locations. Ultrasonic cleaners can remove the debris and be combined with disinfection to achieve true cleaning.

Silverware and silver, copper, or brass decorations: Debris in the grooves and patterns are difficult to remove by regular cleaning methods. Greasy stains can be removed by ultrasonic cleaners with a small amount (around 1 tablespoon or 20 ml) of dish washing liquid. For silver, copper or brass items with oxidation that has darkened the items, add special solution that can remove oxidation. Shininess will reappear after cleaning with ultrasonic cleaners.

Use iSonic Ultrasonic Silver Tarnish Remover #CSST01 to remove silver tarnish.

Eyewear, watch bands, shavers, razors and other household items: Ultrasonic cleaners can be used to clean the debris between the rim and the lenses on eyewear, between razor blades, and on the metal mesh of shavers to keep the blades sharp.

## COMMON CLEANING METHODS

### INDIRECT CLEANING

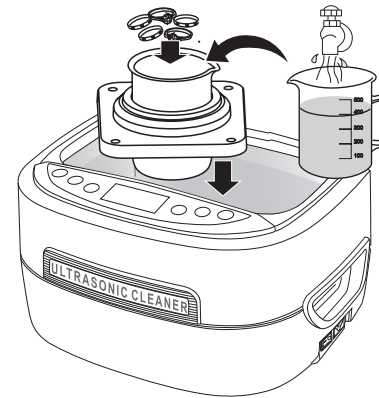

Put the items in a separate container. Use ultrasonic waves to penetrate the container to do the cleaning.

**Applications: To clean items with corrosive or expensive solutions, 3D printed parts, small items, items that can not be in contact with metal. It can also be used for non-cleaning applications such as mixing liposomal vitamin c, steeping, herb extraction, infusion (see separate instructions or contact iSonic).**

#### Different industries use different fluids to be used inside the containers:

1. Watch service shops - Watch oil (to prevent rust)
2. Dental clinics: cement or plaster remover
3. 3D printed parts. 99% isopropyl alcohol.
4. Precision electrical parts – Hexane (to dissolve grease, to evaporate quickly)
5. Mobile phone and electronic service shops - Pure alcohol (to evaporate quickly)
6. Printing shops – Acetone are often used (to dissolve ink)
7. Homes - Rubbing alcohol (to remove odor, to clean and to disinfect at the same time)

Avoid acetone from contacting the plastic housing to prevent corrosion. Use Indirect Cleaning and a glass or metal container for acetone.

#### Cleaning Method:

1. Put the item inside a container. Add proper fluid to submerge the area to be cleaned.
2. Place the container in the tank. Add water to a level between MIN and MAX, not over the container.
3. Touch Time+ key to set the timer to 5 to 10 minutes. Touch Start/Stop key to start cleaning. Ultrasonic waves will penetrate the container and clean the item.

The optimum way is to use a suspended container for indirect cleaning such as using a beaker holder to hold a glass beaker. Optional beaker holder sets with either 500 or 1000 ml capacity are available for this unit.

#### Selection of container:

1. Plastic containers – A plastic container with the same weight as a metal container will absorb more ultrasonic energy. Use thin and stiff container will help to reduce energy absorption.
2. Aluminum containers – Absorbs about 20% of ultrasonic energy.
3. Glass beakers-Absorb about 15% of ultrasonic energy. Do not use thick-walled glass containers such as Mason jars or Pyrex containers.
4. Stainless steel containers – Absorbs about 8% of ultrasonic energy.
5. Use thin, light weight and stiff containers.

# COMMON CLEANING METHODS

## REGULAR CLEANING

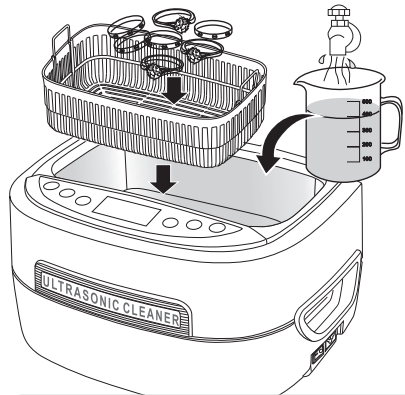

Only tap water is needed.

**Applications: Items with loose or dry debris.**

### Cleaning Method:

1. Add water to the cleaning tank to the level between "MIN" and "MAX" lines and above the area to be cleaned.
2. Put the items to be cleaned inside the basket or directly in the cleaning tank.
3. Touch Time+ key to set the timer 5 to 10 minutes. Press Start/Stop key twice to start cleaning.

### Notes on using the basket:

1. The basket reduces the friction between the items and the tank but it absorbs about 30% of ultrasonic energy and reduces the cleaning effect.
2. When the items are relatively large and with greasy debris, they can be put in the tank directly.

During cleaning, debris will come off the items like "cloud". Water will become murky. Cleaning is done when smoke is no longer visible. Replace the water to wash other items.

## ENHANCED CLEANING

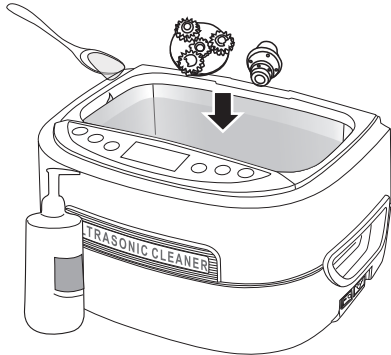

Add proper solution to enhance cleaning effect.

**Applications: Debris accumulated over time, items with grease or heavily soiled.**

### Cleaning Method:

1. Put the items in the cleaning tank directly.  
Do not put the items on top of each other to avoid rubbing during cleaning.
2. Add water to level between MIN and MAX and above the area to be cleaned.
3. Add proper cleaning solution for the application.
4. Touch Heater twice to turn on the heater,  flashes.  
Touch Heater twice again to cancel the heating when the water temperature reaches 104°F (40°C) after about 20 minutes.  
Warm water and proper cleaning solution can soften grease and improve cleaning efficiency.
5. Touch Time+ key to set the timer to 10 minutes. Touch Start/Stop key twice to start cleaning. Grease will dissipate and appear to be like black smoke in the water.

6. Change water and wash the items for another a couple minutes to remove the residual debris and the detergent.
7. Glass beaker with a beaker holder or a stainless steel removable chamber (see Optional Accessories) is one of the best options.



## Shooting Clubs

To reuse brass cartridges: Adding iSonic Ultrasonic Brass Cleaning Solution Concentrate #CSBC001 will make fired brass reusable and like new again.

Gun cleaning and care: Cleaning guns after shooting is time consuming. Adding special solution in the water and using ultrasonic cleaners can complete the cleaning better, quicker and easier than traditional methods.



## Mobile Phone and Electronics Service Shops

PCB renewal: Non-operational electronics, after falling into water, or non-operational key pads can be cleaned with ultrasonic cleaners and pure alcohol to recover the functions.



## Watch Service Shops

Precision parts cleaning: Put small parts in a beaker made of stainless steel or glass filled with lubricant oil, then place the beaker inside the cleaning tank and add water. Ultrasonic waves will penetrate the beaker and act on the parts to make them clean.



## Printing Shops

Unblocking dried printer heads or ink cartridges: Large printers and inkjet printers often have dried printer heads or ink cartridges ports. Replacing them with new ones is very costly. Adding acetone or special cleaning solution and using an ultrasonic cleaner with a couple of minutes of cleaning will remove the blockage and make them usable again.



Avoid acetone from contacting the plastic housing to prevent corrosion. Use Indirect Cleaning explained later and a glass or metal container for acetone.



## Automotive Shops

To clean precision parts: Add 3 tablespoons (50 ml) of dishwashing liquid in the water, turn the heater on to clean precision parts such as valves, injectors, gears and bearings. Ultrasonic cleaners clean debris in tiny holes and crevices effectively, saving time and effort compared to traditional soaking and brushing methods.

## SAMPLE APPLICATIONS

JEWELRY	PERSONAL ITEMS	MEDICAL / DENTAL INSTRUMENTS
		
Necklaces, rings, earrings, bracelets, etc.	Eyeglasses, sunglasses, shaver heads, watch bands, diver's watches, dentures, etc.	Surgical instruments, pliers, handpieces, etc.

PRECISION PARTS	SILVERWARE, SILVER, COPPER OR BRASS DECORATIONS	SMALL ENGINE PARTS
		
Bearings, gears, valves, tools, fuel injectors, etc.	Silverware, silver, copper or brass decorations, etc.	Carburetors, injectors, etc.

LAB ITEMS	BRASS, GUN PARTS	PCB, INKJET CARTRIDGES
		
Test tubes, beakers, flasks, etc.	Reusable brass, gun parts, etc.	PCBs from mobile phones and MP4, ink cartridges, etc.



## CONTROL PANEL AND OPERATIONS

### 1. Indicator Light - Working Status

Green - Normal working status, ready to use.

Red - Under overheat protection. 15 minutes of waiting time is needed for the light to change from red to green. Work can resume afterwards.

### 2. Degas Button - Degas/Normal

Touch Degas key,  illuminates, indicating Degas function is selected. Touch Start/Stop key twice to start degas.  will flash for about 90 seconds, then the unit will return to normal cleaning function. Touch Degas key before it ends will stop degassing. If additional degassing is needed after it ends, touch Degas key again.

#### Degas

When cleaning heavily soiled or greasy items, silver, copper or brass items, chemical solutions need to be added into the water. The solution may form many small droplets and take a long time to dissolve in the water. Newly added water may generate many air bubbles on the tank walls. These will reduce the cleaning effect in the beginning phase of ultrasonic cleaning. Turning on the degas function will dissipate the droplets and the air bubbles, usually in 90 seconds, and improve cleaning efficiency.

### 3. Start/Stop-Start/Stop switch to turn on or turn off ultrasound

After powering on, the LED displays  which is the default time and the unit is ready with normal working status.

Touch Start/Stop key twice and the cleaning starts. The cleaning stops when the timer counts down to . If the unit needs to be stopped before the timer runs up, touch Start/Stop key twice.

4.  Digital LED display of working time. It counts down after work being started.



### 5. — Degas Status



 — Illuminated, the degas function is selected.  — Flashing, degassing is underway.



### 6. — Normal Cleaning Status

 — Illuminated, normal cleaning is underway.

### 7. — Heater Status

Touch Heater key twice,  flashes, indicating the heater is turned on. Touch Heater key twice again,  dims, indicating the heater is turned off. The heater is preset at 60°C (140°F)

8. **Heater Key** — Heater key. Touch Heater key twice,  flashes, indicating the heater is turned on. To cancel heating, Touch Heater key twice,  dims, indicating the heater is turned off.

9. **Time+ Key** — Timer quick set key. Touch time key, LED display shows . Touching it again to change it to . Each touching makes it to increase by 5 minutes.

10. **Time- Key** — Timer decreasing. Each touching reduces the timer by 1 minute.

# PRODUCT STRUCTURE AND ACCESSORIES

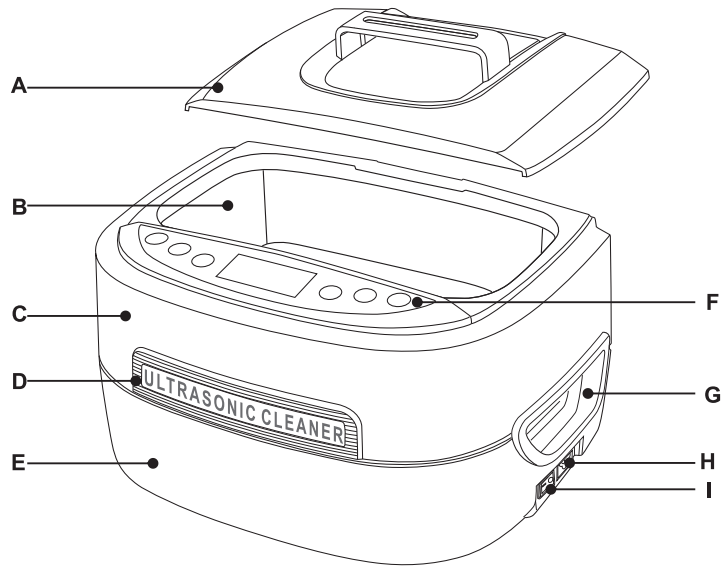

- A.** Top cover
- B.** Stainless steel tank
- C.** Top housing
- D.** Logo block
- E.** Bottom housing
- F.** Control panel
- G.** Handles
- H.** Power socket
- I.** Power switch

## STANDARD ACCESSORIES:



Power cord

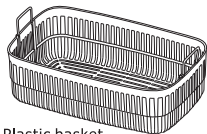

Plastic basket

## OPTIONAL ACCESSORIES:

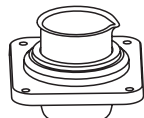

BHK01A  
single beaker holder set,  
500ml beaker

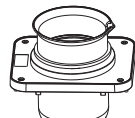

BHK03A  
single beaker holder,  
1000ml beaker

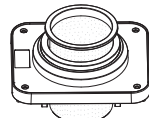

BHK05A  
single beaker holder with 500ml  
perforated stainless steel beaker



SB4820B  
(stainless steel wire mesh basket)

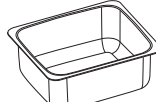

IT4821A  
(removable cleaning chamber)

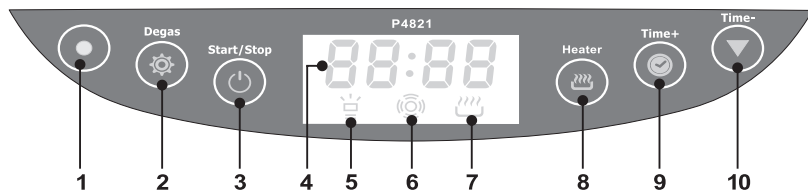

# SAMPLE APPLICATIONS

PERSONAL HEALTH CARE ITEMS	ELECTRICAL PARTS	LENSES, CRYSTALS
C-PAP face mask, tubing, etc.	Terminals for relays and contactors	Lenses, crystals

# PRODUCT EXPLOSION PICTURE

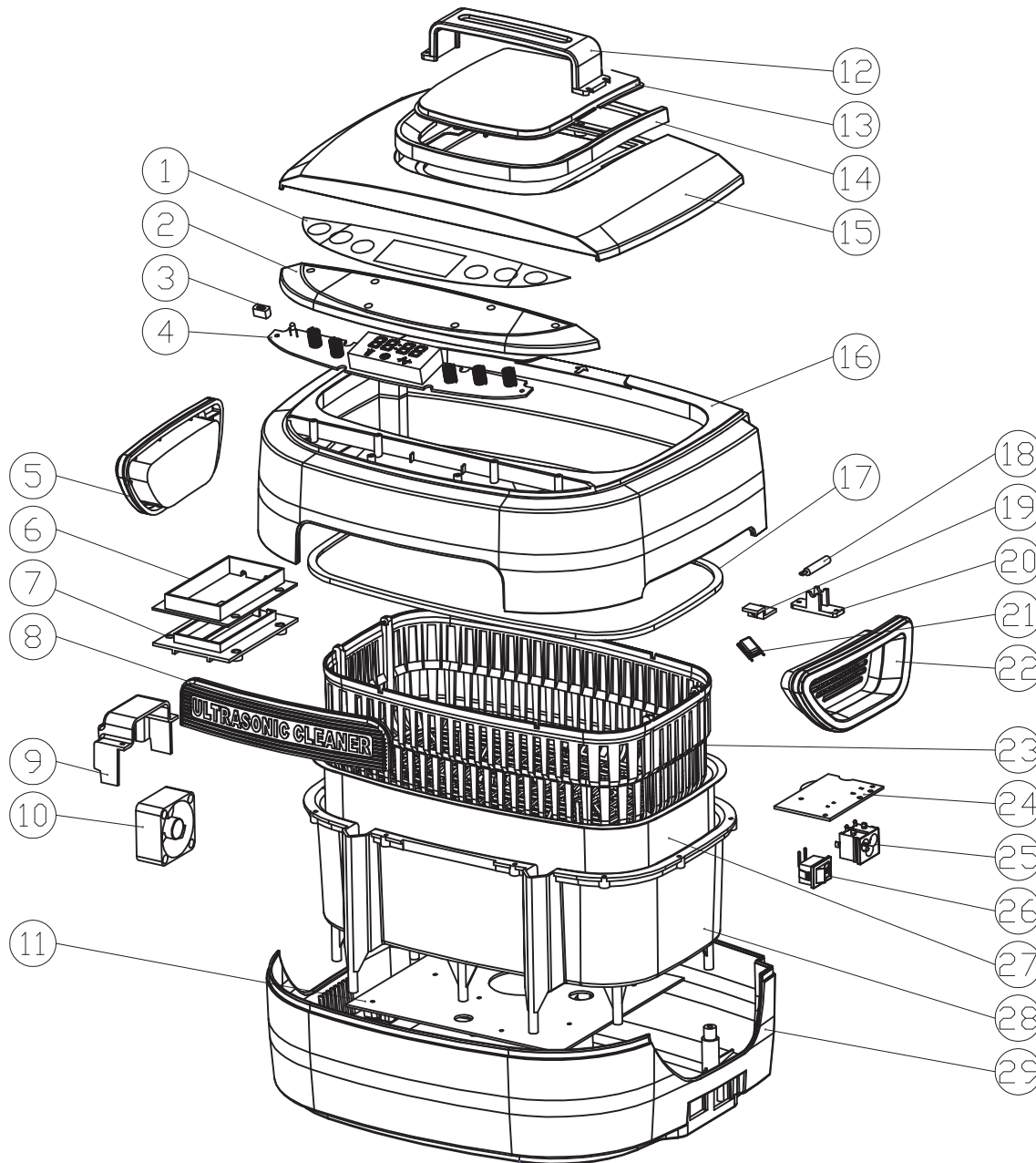

No.	Item	Material
①	Panel cover	PC
②	Control panel box	ABS
③	Light socket	ABS
④	Control PCB	94V0
⑤	Left handle	ABS
⑥	Heater pocket	PA 66
⑦	Heater cover	PA 66
⑧	Logo block	ABS
⑨	Cooling fan bracket	ABS
⑩	Cooling fan	Standard part
⑪	Main PCB	94V0
⑫	Stainless steel handle	SUS 304
⑬	Lid-window	AS
⑭	Lid window bracket	ABS
⑮	Lid	ABS
⑯	Top housing	ABS
⑰	Silicon seal	Silicone rubber
⑱	Thermocouple	Standard part
⑲	Thermal cutoff holder	ABS
⑳	Thermocouple holder	ABS
㉑	Thermal cutoff	Standard part
㉒	Right handle	ABS
㉓	Plastic basket	ABS
㉔	Power PCB	94V0
㉕	Power socket	Standard part
㉖	Power switch	Standard part
㉗	Stainless steel tank	SUS 304
㉘	Inner tank	ABS
㉙	Bottom housing	ABS